

SUPPRESSOR F51

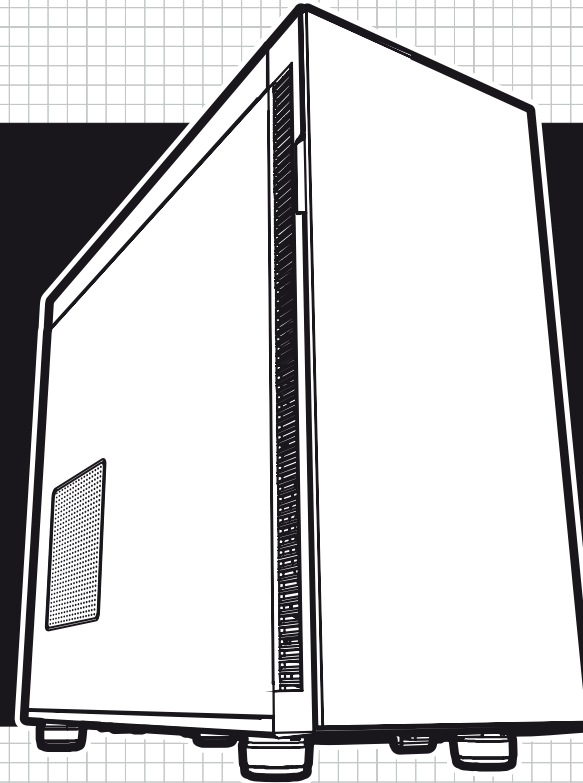

User's Manual
Benutzerhandbuch
Mode d'emploi
Manual del usuario
Manuale dell'utente
Manual do Utilizador
安裝說明書
用戶手冊
ユーザーズマニュアル
Руководство пользователя
kullanıcı elkitabı
(EEE Yönetmeliğine Uygundur)
คู่มือการใช้



© 2015 Thermaltake Technology Co., Ltd. All Rights Reserved. 2015.05
All other registered trademarks belong to their respective companies. www.thermaltake.com

Join Tt Community To Receive Benefits



Dear Valued Customer,
Thank you for choosing Thermaltake.
As a new user we value your thoughts and opinions and your feedback is important to us. We at Thermaltake would like to use this opportunity to invite you to join our Community Forums. Register today to start enjoying the full benefits of our community.



Benefits of being a member:

- Quick and responsive user support
- Receive help and advice with new builds
- Keep up to date with new product releases
- Share your thoughts and builds with the community
- Enter monthly contests and giveaways

Tt LCS-Liquid Cooling Support Certification



Tt LCS Certified is a Thermaltake exclusive certification applied to only products that pass the design and hardcore enthusiasts standards that a true LCS chassis should be held to. The Tt LCS certification was created so that we at Thermaltake can designate to all power users which chassis have been tested to be best compatible with extreme liquid cooling configurations to ensure you get the best performance from the best features and fitment.

Brand official website
<http://www.thermaltake.com/>

Global Facebook
<https://www.facebook.com/ThermaltakeInc>

Taiwan Facebook
<http://www.facebook.com/ThermaltakeTW>

Global community forums
<http://community.thermaltake.com>

CONTENTS

Chapter 1. Product Introduction

1.0	Specification	01
1.1	Accessory	01
1.2	Warning and Notice	02

Chapter 2. Installation Guide

2.0	Side Panels Disassembly	04
2.1	Power Supply Unit (PSU) Installation	05
2.2	Motherboard Installation	06
2.3	5.25" Device Installation	07
2.4	3.5" & 2.5" HDD Installation	08
2.5	PCI Card Installation	10
2.6	Keyboard & Mouse Security Lock Usage	11
2.7	Air Cooling Installation	12
2.8	Liquid Cooling Installation	13
2.9	Filter Installation	14
2.10	Soundproofed Cover Installation	15
2.11	Door Lock Usage	17

















Chapter3 Leads Installation Guide

3.0	Case LED connection	18
3.1	USB 3.0 connection	18
3.2	Audio connection	18

Specification

Case Type	Mid Tower
Dimension (H*W*D)	525 x 230 x 577 mm (20.6 x 9.1 x 22.7 inch)
Material	SPCC
Cooling System	Front (intake) : 200 x 200 x 30 mm fan (600~800rpm, 13~15dBA) Rear (exhaust) : 140 x 140 x 25 mm Turbo fan (1000rpm, 16dBA)
Fan Support	Front: 3 x 120mm 2 x 140mm 1 x 200mm Top: 3 x 120mm 3 x 140mm 2 x 200mm Rear: 1 x 140mm or 1 x 140mm Side: 1 x 120mm or 1 x 140mm Bottom: 2 x 120mm
Radiator Support	Front: 1 x 360mm 1 x 420mm Top: 1 x 360mm 1 x 420mm Rear: 1 x 120mm Bottom: 1 x 240mm
Clearance	CPU cooler height limitation: 185mm VGA length limitation: 310mm (with HDD rack) 465mm (without HDD rack) PSU length limitation: 220mm (With Bottom Fan)

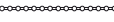
Accessory

Figure	Parts Name	Q'ty	Figure	Used for
	Stand-off #6-32 x 6mm	4		Motherboard
	Screw #6-32 x 6mm	4		Power
	Screw #6-32 x 5mm	10		HDD
	Screw M3 x 5mm	20		Motherboard , ODD
	Screw M3 x 5mm	20		2.5" HDD
	Nut Setter	1		Stand-off
	Screw Ø5 x 12mm	4		Case Fan
	Screw #6-32 x 32mm	4		200mm x 30mm Fan
	Cable Tie	5		Cable Management
	Buzzer	1		Motherboard Alarm

Warning and Notice

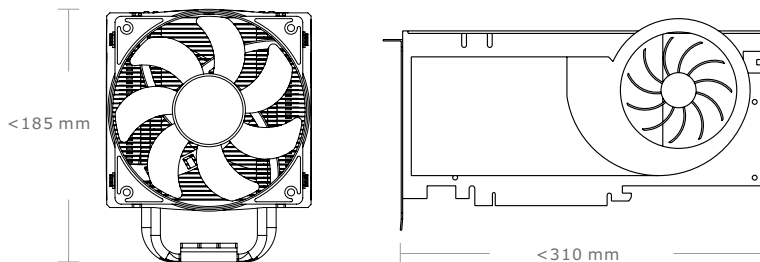

Warning!!

CPU Cooler Height Limitation:

Please ensure that your CPU cooler does NOT exceed 185mm (7.3 inches) height.

VGA (Add-on card) Length Limitation:

Please ensure that your VGA (Add-on card) does NOT exceed 310mm (12.2 inches) length.

Warnung!!

CPU-Kühler Höhenbeschränkung:

Bitte stellen Sie sicher, dass Ihr CPU-Kühler 185 mm (7,3 Zoll) Höhe nicht überschreitet.

VGA (Add-on-Karte) Längenbeschränkung:

Bitte stellen Sie sicher, dass Ihre VGA (Add-on-Karte) 310 mm (12,2 Zoll) Länge nicht überschreitet.

Avertissement !

Limite de hauteur du ventilateur de CPU :

Vérifiez que la hauteur du ventilateur de CPU ne dépasse pas 185 mm.

Limite de longueur de la carte (complémentaire) VGA :

Vérifiez que la longueur de votre carte (complémentaire) VGA ne dépasse pas 310 mm

Precaución

Limitación de altura del refrigerador de CPU:

Asegúrese de que la altura de su refrigerador de CPU no excede los 185 mm (7,3 pulgadas).

Limitación de longitud de la tarjeta de vídeo (adicional):

Asegúrese de que la longitud de su tarjeta de vídeo (adicional) no excede los 310 mm (12,2 pulgadas).

Attenzione!

Limitazione altezza dissipatore CPU:

Assicurarsi che l'altezza del dissipatore CPU NON superi 185 mm (7,3 pollici).

Limitazione lunghezza VGA (scheda aggiuntiva):

Assicurarsi che la lunghezza del VGA (scheda aggiuntiva) NON superi 310 mm (12,2 pollici).

Atenção!!

Limite de altura para o dissipador do CPU:

O limite de altura para o dissipador do CPU é 185 mm (7,3 polegadas).

Limite de comprimento para VGA (placa gráfica):

O limite de comprimento para VGA (placa gráfica) é 310 mm (12.2 polegadas).

警告 !!

CPU 冷却器的高度限制：

請確保 CPU 冷却器的高度不超過 185 mm (7.3 英寸)。

VGA (附加介面卡) 的長度限制：

請確保 VGA (附加介面卡) 的長度不超過 310 mm (12.2 英寸)。

警告 !!

CPU 散热器高度限制：

请确保 CPU 散热器的高度不超过 185 mm (7.3 英寸) 。

VGA (附加卡) 长度限制：

请确保 VGA (附加卡) 的长度不超过 310 mm (12.2 英寸) 。

警告

CPUクーラーの高さ制限:

CPUクーラーの高さが185mmを超えていないことを確認してください。

VGA (アドオンカード) の長さ制限:

VGA (アドオンカード) の長さが310mmを超えていないことを確認してください。

Внимание!

Ограничение по высоте охладителя ЦП

Убедитесь, что высота охладителя ЦП (центрального процессора) НЕ превышает 185 мм (7,3 дюйма).

Ограничение по длине видеокарты VGA (плата расширения)

Убедитесь, что длина видеокарты VGA (плата расширения) НЕ превышает 310 мм (12,2 дюйма).

Uyar!!

CPU Soğutucu Yükseklik Sınırlaması:

Lütfen CPU soğutucunuzun yüksekliğinin 185mm'yi (7,3 inç) GEÇMEDİĞİNDEN emin olun.

VGA (Eklenli kart) Uzunluk Sınırlaması:

Lütfen VGA'nızın (Eklenli kart) uzunluğunun 310mm'yi (12,2 inç) GEÇMEDİĞİNDEN emin olun.

คำเตือน!!

ขีดจำกัดความสูงสำหรับฮีตซิงก์ของ CPU:

ขีดจำกัดความสูงสำหรับฮีตซิงก์ของ CPU คือ 185 มม. (7.3 นิ้ว)

ขีดจำกัดความยาวสำหรับ VGA (การ์ดแสดงผล):

ขีดจำกัดความยาวสำหรับ VGA (การ์ดแสดงผล) คือ 310 มม. (12.2 นิ้ว)

Side Panels Disassembly

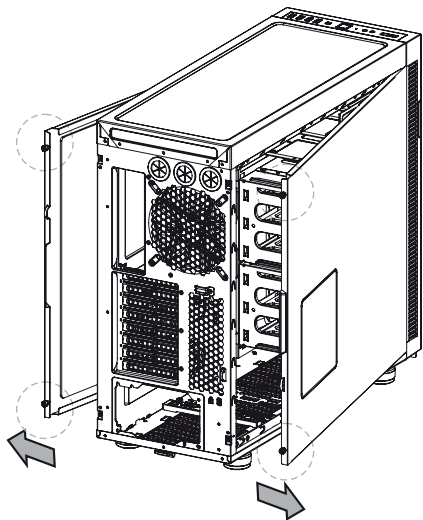

English /
Remove the screws on the back of the chassis, and open the side panel

繁體中文 /
移除機殼後方螺絲，將側窗打開

Deutsch /
Entfernen Sie die Schrauben auf der Rückseite des Gehäuses und öffnen Sie das Seitenteil

简体中文 /
卸除机壳后方螺丝，将侧窗打开

Français /
Enlevez les vis à l'arrière du châssis et ouvrez le panneau latéral

日本語 /
シャーシ背面のねじを取り外し、サイドパネルを開きます

Español /
Extraiga los tornillos de la parte posterior de la caja y abra el panel lateral

Русский /
Открутите винты на задней стенке корпуса и откройте боковую панель

Italiano /
Rimuovere le viti sulla parte posteriore dello chassis e aprire il pannello laterale

Türkçe /
Kasanın arkasındaki vidaları çıkarın ve yan paneli açın

Português /
Remova os parafusos na parte de trás da caixa e abra o painel lateral

ภาษาไทย /
ถอดสกรูที่ด้านหลังของแชสซีส์ แล้วเปิดแผงด้านข้าง

Power Supply Unit (PSU) Installation

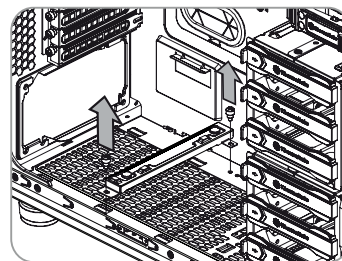

Español /
1. Instale la PSU en la ubicación correcta.
2. Ajuste el puente de soporte de la PSU en la ubicación adecuada y asegúrela con tornillos.

Italiano /
1. Posizionare la PSU in modo corretto.
2. Regolare il ponticello di supporto della PSU nella posizione corretta e fissare la PSU con delle viti.

Português /
1. Coloque o PSU na sua devida posição.
2. Ajuste a ponte de suporte do PSU para a devida posição e fixe o PSU com parafusos.

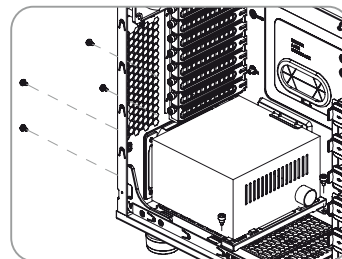

繁體中文 /
1. 將電源供應器放在正確的位置
2. 將電源供應器支撐架調整到適當的位置，然後用螺絲固定電源供應器。

简体中文 /
1. 将电源供应器放在正确的位置
2. 将电源供应器支撑架调整到适当的位置，然后用螺丝固定电源供应器。

日本語 /
1. PSUを適切なロケーションに取り付けます。
2. PSU支持ブリッジを適切なロケーションに合うように調整し、ねじでPSUを締め付けます。

English /
1. Place the PSU in proper location.
2. Adjust the PSU supporting bridge to the proper location and secure the PSU with screws.

Русский /
1. Установите блок питания в надлежащее место.
2. Надлежащим образом установите поддерживающий мост блока питания и закрепите блок питания винтами.

Deutsch /
1. Platzieren Sie das Netzteil in der richtigen Position.
2. Richten Sie die Stützbrücke für das Netzteil entsprechend aus und sichern Sie das Netzteil mit Schrauben.

Türkçe /
1. PSU'yu, uygun konuma yerleştirin.
2. PSU destek köprüsünü uygun konuma ayarlayın ve PSU'yu vidalarla sabitleyin.

Français /
1. Placez l'alimentation dans la position appropriée.
2. Ajustez le pont de support de l'alimentation dans la position appropriée et fixez l'alimentation à l'aide des vis.

ภาษาไทย /
1. วาง PSU ในตำแหน่งที่เหมาะสม
2. ขยับบริดจ์ที่รองรับ PSU ให้อยู่ในตำแหน่งที่เหมาะสม แล้วขันสกรูยึด PSU ให้แน่น

Motherboard Installation

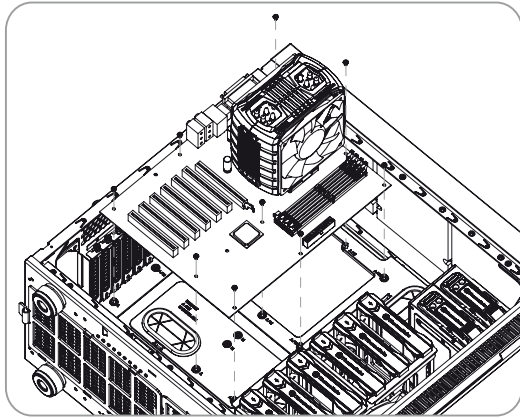

English /

1. Lay down the chassis.
2. Install the motherboard in proper location and secure it with screws.

Deutsch /

1. Legen Sie das Gehäuse auf die Seite.
2. Installieren Sie die Hauptplatine in ihrer vorgesehenen Position und sichern Sie sie mit Schrauben.

Français /

1. Posez à plat le châssis.
2. Installez la carte mère dans l'endroit approprié et sécurisez-la avec des vis.

Español /

1. Tumbé el chasis.
2. Instale la placa madre en la ubicación adecuada y asegúrela con tornillos.

Italiano /

1. Poggiare lo chassis.
2. Installare la scheda madre nella posizione appropriata e fissarla con le viti.

Português /

1. Deixe a caixa.
2. Instale a motherboard no local adequado e aparafuse.

繁體中文 /

1. 將機殼平放。
2. 將主機板放置在合適的位置並用零件包中之螺絲固定。

簡體中文 /

1. 放平机箱。
2. 在合适的位置安装主板并以螺丝安全固定。

日本語 /

1. シャーシを下に置きます。
2. マザーボードを適切な場所に取り付け、ねじで固定します。

Русский /

1. Раскройте системный блок.
2. Установите материнскую плату в надлежащее место и закрепите ее винтами.

Türkçe /

1. Kasayı yan yatırın.
2. Ana kartı uygun konuma takın ve vidalarla sabitleyin.

ภาษาไทย /

1. วางแชสซีส์นอนลง
2. ติดตั้งเมนบอร์ดในตำแหน่งที่เหมาะสมแล้วขันสกรูยึดให้แน่น

5.25" Device Installation

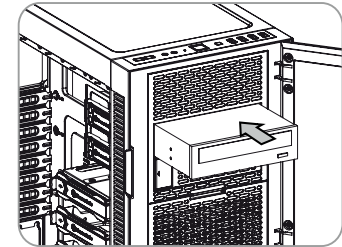
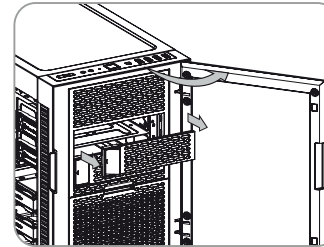

English /

1. Remove the 5.25" drive bay cover.
 2. Slide the 5.25" device into the drive bay to lock the device.
- Note: Press the 5.25" tool-free mechanism to unlock the device.

Deutsch /

1. Entfernen Sie die Abdeckung des 5,25 Zoll Laufwerksschachts.
 2. Schieben Sie the 5,25 Zoll Einheit in den Laufwerksschacht, um die Einheit zu sperren.
- Anmerkung: Drücken Sie den 5,25 Zoll werkzeuglosen Mechanismus, um die Einheit zu verriegeln.

Français /

1. Enlevez le couvercle de la baie de lecteur de 5,25".
2. Faites glisser le périphérique de 5,25" dans la baie de lecteur.

Remarque : Appuyez sur le mécanisme sans outil de 5,25" pour déverrouiller le périphérique.

Español /

1. Extraiga la tapa del hueco de la unidad de 5,25".
 2. Meta el dispositivo de 5,25" en el hueco de la unidad para cerrar el dispositivo.
- Nota: Presione el mecanismo libre de herramienta de 5,25" para abrir el dispositivo.

Italiano /

1. Rimuovere il coperchio dell'alloggiamento vano unità da 5,25".
 2. Fare scorrere il dispositivo da 5,25" nell'alloggiamento dell'unità per bloccare il dispositivo.
- Nota: Premere il meccanismo tool-free da 5,25" per sbloccare il dispositivo.

Português /

1. Remova a cobertura da baía da unidade de 5,25".
 2. Deslize o dispositivo de 5,25" para a baía da unidade, para bloquear o dispositivo.
- Nota: Premere o mecanismo de 5,25" sem utilizar ferramentas para desbloquear o dispositivo.

繁體中文 /

1. 移除5.25"擴充槽檔板
 2. 將5.25"裝置至適當的位置
- 注意: 如需移除5.25"裝置, 先按壓5.25"無螺絲機構, 再將5.25"裝置往前推出。

簡體中文 /

1. 移除5.25"槽蓋
 2. 將5.25"設備滑入驅動器槽
- 注意: 如需移除5.25"設備, 先按壓5.25"免用工具機械裝置, 再將5.25"設備往前推出

日本語 /

1. 5.25"ドライブベイのカバーを取り外します。
 2. 5.25"デバイスをドライブベイにスライドさせてデバイスをロックします。
- 注: 5.25"工具不要メカニズムを押してデバイスをアンロックします。

Русский /

1. Снимите крышку отсека для 5,25-дюймовых дисководов.
 2. Вставьте 5,25-дюймовое устройство в отсек дисководов для фиксации.
- Примечание. Нажмите на не требующий использования инструментов механизма отсека для 5,25-дюймовых дисководов, чтобы разблокировать устройство.

Türkçe /

1. 5,25" sürücü bölmesi kapağını çıkarın.
 2. 5,25" aygıtını kilitlemek için sürücü bölgesinin içine doğru kaydırın.
- Not: Aygıtın kilidini açmak için 5,25" araçsız mekanizmayı bastırın.

ภาษาไทย /

1. ถอดฝาปิดช่องไดรฟ์ขนาด 5.25" ออก
 2. เสียบอุปกรณ์ขนาด 5.25" เข้าในช่องไดรฟ์เพื่อล็อกอุปกรณ์
- หมายเหตุ: กดตัวล็อกเครื่องมือขนาด 5.25" เพื่อปลดล็อกอุปกรณ์

3.5" & 2.5" HDD Installation

Type A

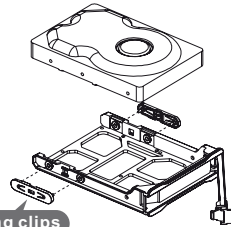
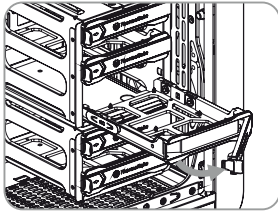

Locking clips

For 3.5" HDD: Secure 3.5" HDD from both side of the HDD tray by locking clips.

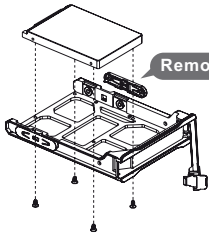

Remove this locking clip

For 2.5" HDD: Secure 2.5" HDD from the bottom of the HDD by screws.

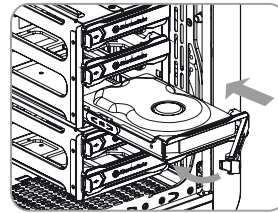

Type B

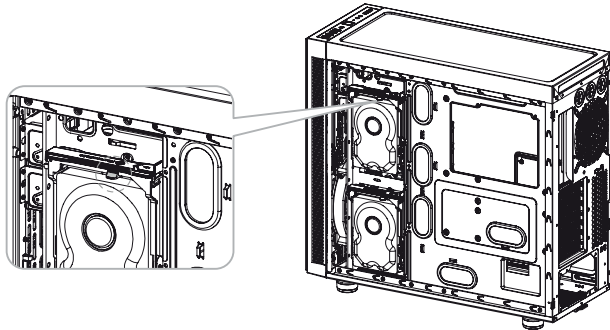

Type C ODD Tray Installation

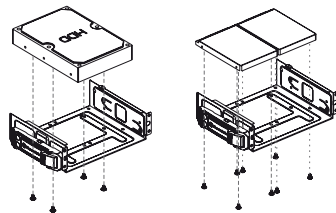

English /

1. Press a latch to pull the tray out.
2. Remove the locking clips then position the HDD in the tray and secure the HDD with the locking clips.
3. Slide the tray back to the drive bay.

Deutsch /

1. Drücken Sie auf eine Lasche, um den Schacht herauszuziehen.
2. Entfernen Sie die Halte-Clips, positionieren Sie dann die HDD in dem Schacht und befestigen Sie die HDD mit den Halte-Clips.
3. Schieben Sie den Schacht zurück in den Laufwerksschacht.

Français /

1. Appuyez sur un loquet pour enlever le boîtier.
2. Enlevez les clips de verrouillage puis placez le disque dur dans le boîtier et fixez le disque dur avec les clips de verrouillage.
3. Refaites glisser le boîtier dans la baie de lecteur.

Español /

1. Presione un pasador para extraer la bandeja.
2. Extraiga los ganchos de bloqueo, coloque el disco duro en la bandeja y fíjelo con los ganchos de bloqueo.
3. Vuelva a meter la bandeja en el hueco de la unidad.

Italiano /

1. Stringere un laccio per estrarre il vano.
2. Rimuovere le clip di bloccaggio, quindi posizionare l'HDD nel vano e fissarlo con le clip di bloccaggio.
3. Fare scorrere il vano verso l'alloggiamento dell'unità.

Português /

1. Prima um trinco para puxar a bandeja para fora.
2. Remova os cliques de bloqueio e posicione o disco rígido na bandeja. Prenda o disco rígido com os cliques de bloqueio.
3. Deslize a bandeja de volta para a baía da unidade.

繁體中文 /

1. 輕壓硬碟托盤左側開啟硬碟托盤，並向外拉出硬碟托盤。
2. 先移除左右2片扣具，將硬碟放至於硬碟托盤上，扣具扣回固定硬碟。
3. 將硬碟托盤放回硬碟磁架中，按壓硬碟托盤把手以固定硬碟。

简体中文 /

1. 压下专用工具机械装置以卸下硬盘托盘，然后拉出托盘。
2. 卸下2个扣具，将硬盘驱动器放置在托盘上，然后压回扣具固定。
3. 将硬盘托盘滑回硬盘盒，并按下把手以锁定硬盘托盘。

日本語 /

1. ラッチを押してトレイを引き出します。
2. ロッキングクリップを取り外してからHDDをトレイに設置し、HDDをロッキングクリップで固定します。
3. トレイをドライブベイまでスライドさせて戻します。

Русский /

1. Нажмите защелку, чтобы вытянуть лоток.
2. Снимите фиксаторы, вставьте жесткий диск в лоток и закрепите диск фиксаторами.
3. Установите лоток обратно в отсек дисководов.

Türkçe /

1. Tepsiyi dışarı çekmek için bir mandala basın.
2. Kilitleme klipsini çıkarın ve HDD'yi tepsinin içine yerleştirip kilitleme klipsiyle sabitleyin.
3. Tepsiyi tekrar sürücü bölmesinin içine kaydırın.

ภาษาไทย /

1. กดสลักเพื่อดึงถาดออก
2. ถอดคลิปปล๊อคออกจากนั้นวางฮาร์ดดิสก์ไดรฟ์ลงในถาดแล้วล็อคไว้ด้วยคลิปปล๊อค
3. เลื่อนถาดกลับเข้าไปในช่องไดรฟ์

PCI Card Installation

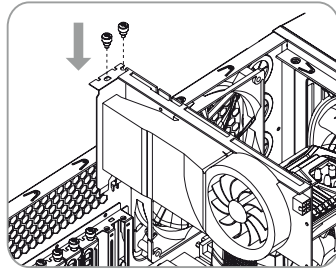
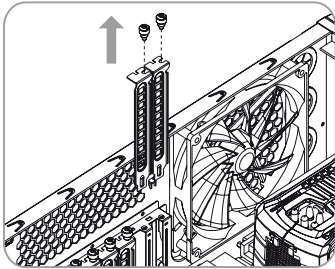

English /
Insert the PCI card into the PCI slot, and secure it with screw.

Deutsch /
Stecken Sie die PCI Karte in den PCI Steckplatz und sichern Sie sie mit Schrauben.

Français /
Insérez la carte PCI dans le slot PCI et sécurisez-la avec des vis.

Español /
Inserte la tarjeta PCI en la ranura del PCI y asegúrela con tornillos.

Italiano /
Inserire la scheda PCI nello slot PCI e fissarla con la vite.

Português /
Insira a placa PCI na ranhura PCI e fixe com parafusos.

繁體中文 /
將 PCI 卡插入 PCI 插槽，然後用螺絲固定。

簡體中文 /
將 PCI 卡插入 PCI 插槽并以螺絲固定。

日本語 /
PCI カードを PCI スロットに挿入し、ねじで固定します。

Русский /
Вставьте PCI-карту в слот PCI и закрепите ее винтом.

Türkçe /
PCI kartını, PCI yuvasına yerleştirin ve vidayla sabitleyin.

ภาษาไทย /
ใส่การ์ด PCI ในสล็อต PCI แล้วขันสกรูยึดให้แน่น

Keyboard & Mouse Security Lock Usage

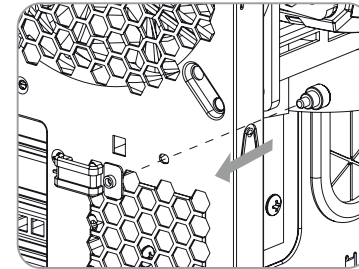

English /
Place the keyboard or mouse cables through the "Keyboard & Mouse Security Lock" then secure it back to the back panel from inside of the chassis with screw.

Deutsch /
Führen Sie die Kabel durch die Einheit "Tastatur- & Mausperren" und sichern Sie sie dann wieder an der Rückwand innerhalb des Gehäuses mit den Schrauben.

Français /
Mettez les câbles du clavier ou de la souris à travers le "verrou de sécurité de clavier & souris" puis sécurisez-les sur le panneau arrière à l'intérieur du châssis avec des vis.

Español /
Mettez les câbles du clavier ou de la souris à travers le "verrou de sécurité de clavier & souris" puis sécurisez-les sur le panneau arrière à l'intérieur du châssis avec des vis.

Italiano /
Posizionare i cavi della tastiera o del mouse sulla "tastiera e il blocco di sicurezza del mouse", quindi fissarli sul pannello posteriore dall'interno dello chassis con la relativa vite.

Português /
Passe os cabos do teclado ou do rato através do "Bloqueio de Segurança do Teclado e Rato" e fixe na parte traseira do painel no interior do chassis, com parafusos.

繁體中文 /
將鍵盤或滑鼠纜線穿過「鍵盤和滑鼠安全鎖」，然後用螺絲將其固定回機殼內的背板。

簡體中文 /
將鍵盤或鼠標纜線穿過“鍵盤和鼠標安全鎖”，然後用螺絲將其固定回機箱內側。

日本語 /
「キーボードとマウスのセキュリティロック」を通してキーボードまたはマウスケーブルを収納し、ねじでシャーシ内部から背面パネルに再び締め付けます。

Русский /
Проведите кабели клавиатуры и мыши через замок и подключите их. Закрутите замок обратно изнутри корпуса.

Türkçe /
Klavye veya fare kablolarını "Klavye ve Fare Güvenlik Kilidi" üzerinden yerleştirin ve daha sonra, güvenlik kilidini kasanın iç tarafından arka panele yeniden vidalayın.

ภาษาไทย /
เดินสายแป้นพิมพ์หรือสายเมาส์ลอดผ่าน "อุปกรณ์เก็บสายแป้นพิมพ์และเมาส์" จากนั้นให้ขันสกรูยึดอุปกรณ์เก็บสายพร้อมสายเข้ากับแผงด้านหลังของแชสซีส์ให้แน่น

Air Cooling Installation

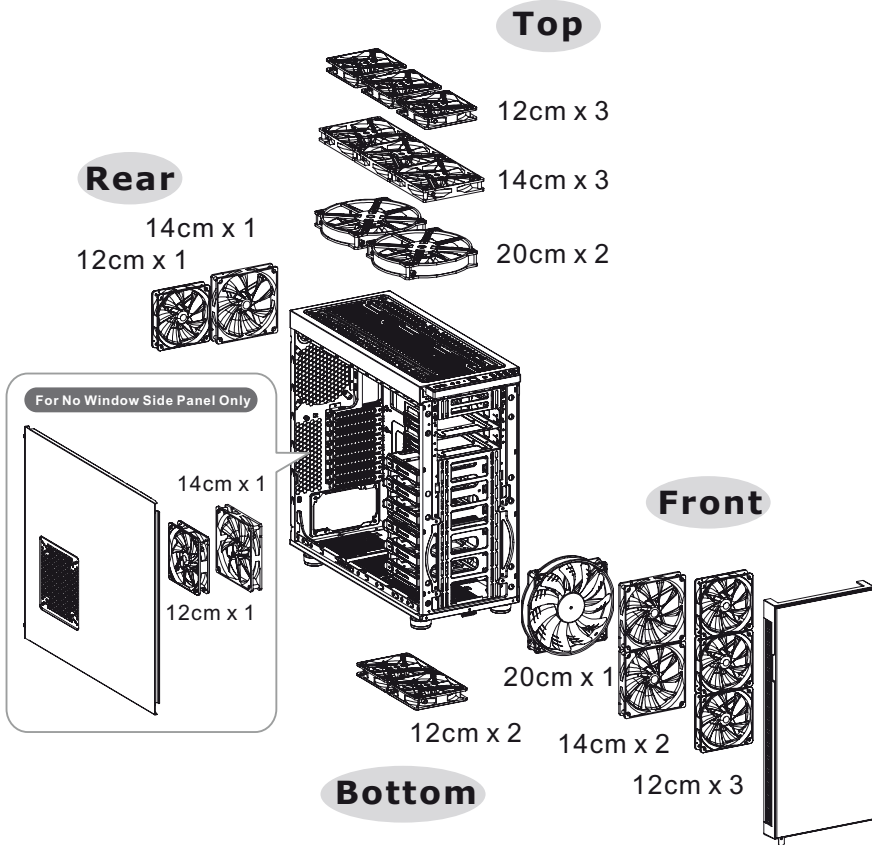

Liquid Cooling Installation

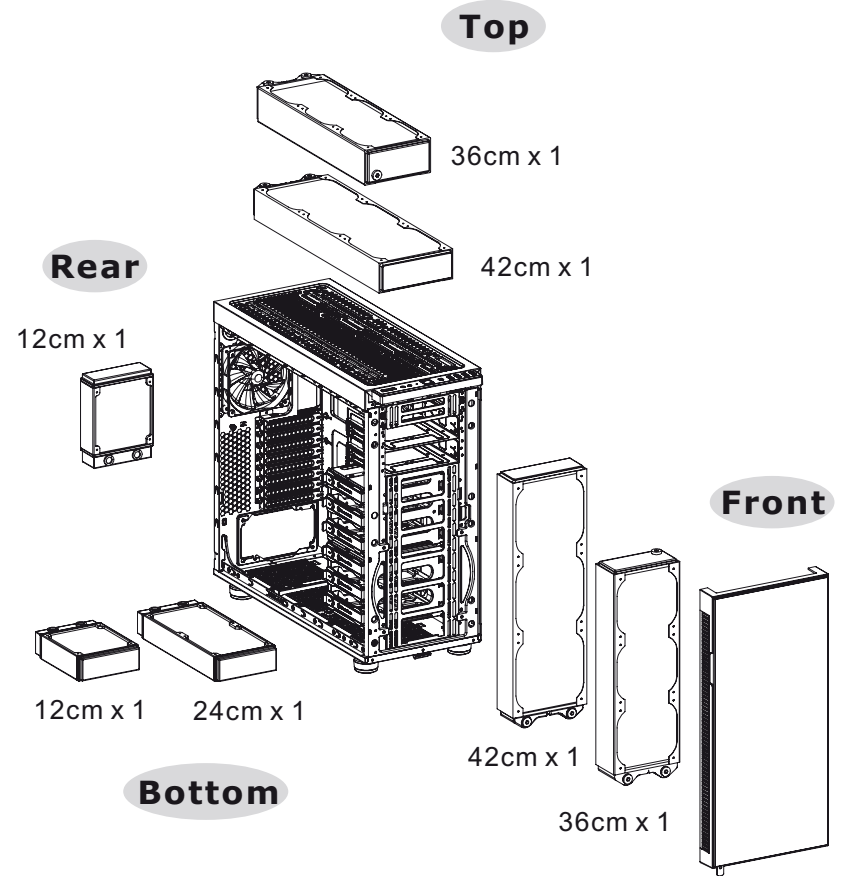

Filter Installation

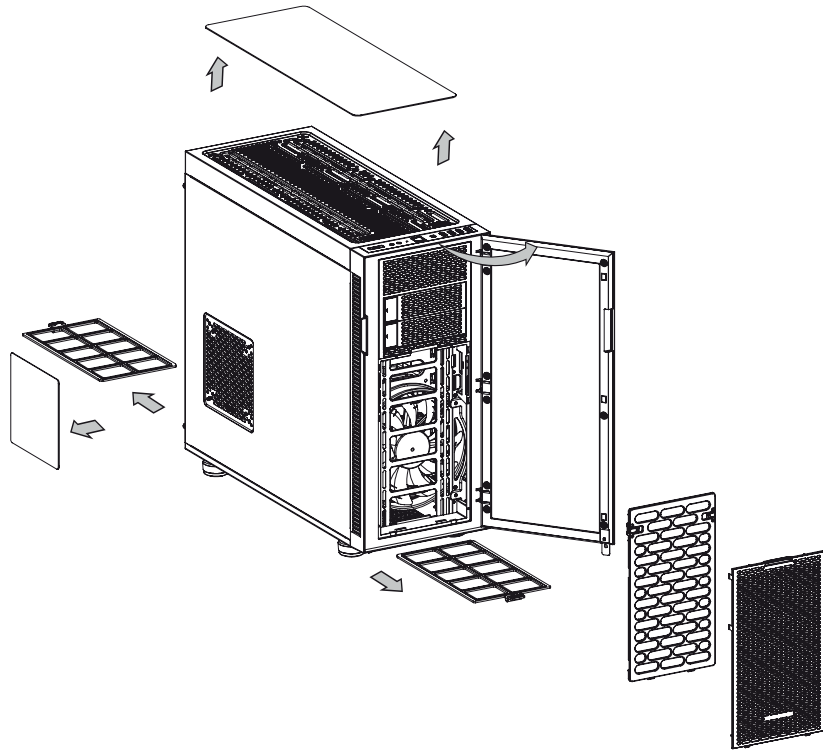

Soundproofed cover installation

Top panel

Remove soundproofed cover for additional fan slots

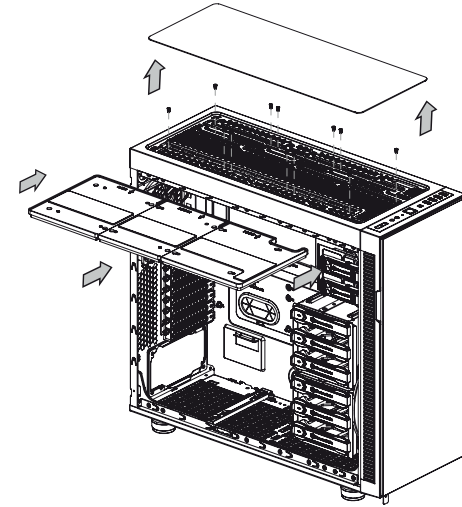

Side panel

For No Window Side Panel Only

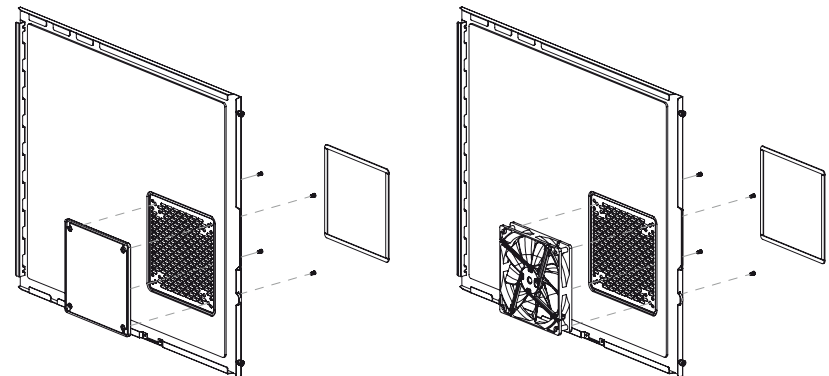

Flexible covers mounting, for balance air flow and sound absorbing

Type A

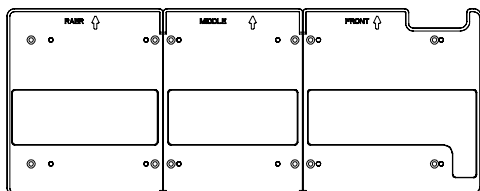

Type B

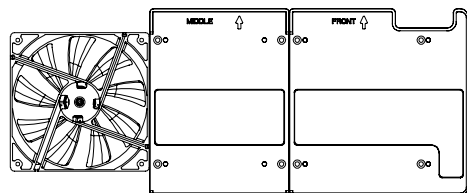

Type C

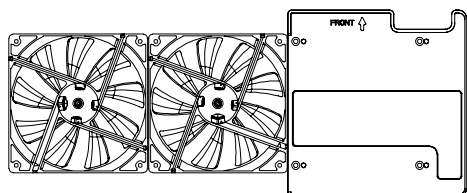

Type D

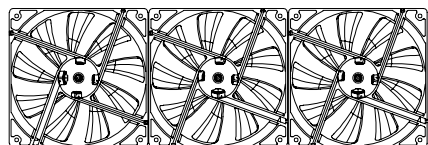

Door Lock Usage

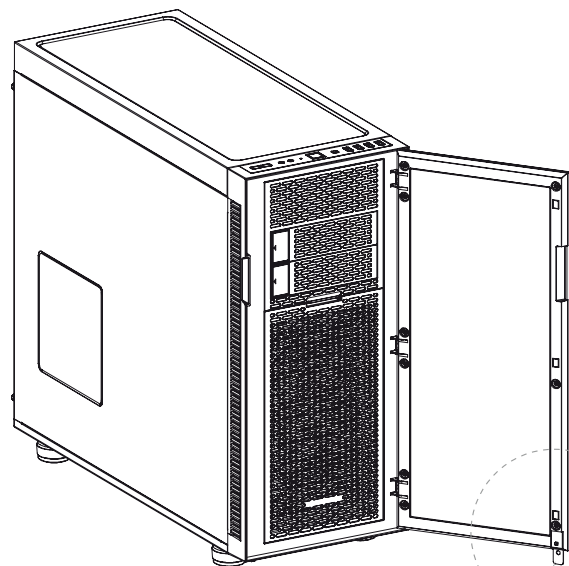

Buckle the rubber band to fix the door

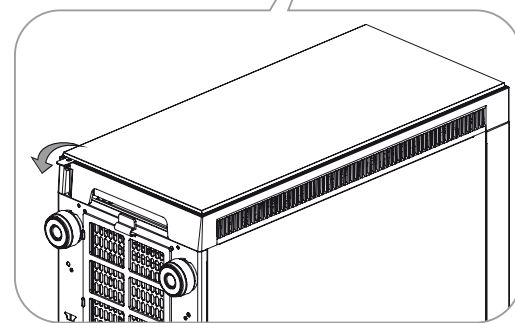

Leads Installation

English

Leads Installation Guide

Case LED Connection / On the front of the case, you can find some LEDs and switch leads. Please consult your user manual of your motherboard manufacturer, then connect these leads to the panel header on the motherboard.

USB 3.0 Connection / Please consult your motherboard manual to find out the section of "USB connection".

USB 3.0 connection /

1. Make sure your motherboard supports USB 3.0 connection.
2. Connect the USB 3.0 cable to the available USB 3.0 port on your computer.

Audio Connection / Please refer to the following illustration of Audio connector and your motherboard user manual. Please select the motherboard which used AC'97 or HD Audio (Azalia), (be aware of that your audio supports AC'97 or HD Audio (Azalia)) or it will damage your device(s).

Deutsch

Anschlüsse herstellen

Gehäuse-LED-Verbindungen / Auf der Gehäusevorderseite finden Sie einige LEDs und Verbindungen. Bitte nehmen Sie die Gebrauchsanweisung Ihres Motherboard Herstellers zur Hilfe und schließen Sie diese Verbindungen an die Panel Header Belegung des Motherboards an.

USB 2.0 Anschluss / Bitte nehmen Sie die Gebrauchsanweisung Ihres Motherboards zur Hilfe und lesen Sie unter dem Kapitel „USB Anschlüsse“ nach.

USB 3.0 Anschluss /

1. Stellen Sie sicher, dass Ihre Hauptplatine den USB 3.0 Anschluss unterstützt.
2. Verbinden Sie das USB 3.0 Kabel mit dem USB 3.0 Port auf Ihrem Computer.

Audio Anschlüsse / Bitte beachten Sie die folgende Abbildung der Audio Anschlüsse und die Anweisung in der Gebrauchsanweisung Ihres Motherboards. Bitte wählen Sie das Motherboard, das AC'97 oder HD Audio (Azalia) verwendet, (achten Sie darauf, dass Ihr Audio AC'97 bzw. HD Audio (Azalia unterstützt)). Andernfalls entstehen schwere Schäden an Ihrem(n) Gerät(en)!!!

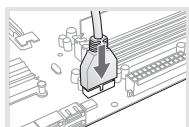
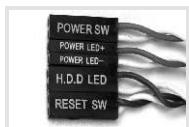

USB 3.0 Connection

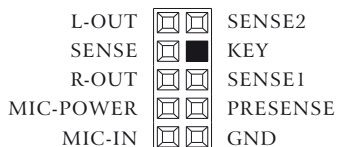

AUDIO AZALIA Function

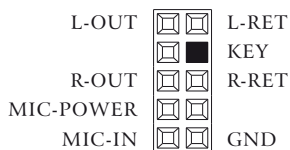

AUDIO AC'97 Function

Français

Guide d'installation des fils

Connexion des voyants du boîtier / Sur la face avant du boîtier, vous trouverez plusieurs voyants et les fils des boutons. S'il vous plaît consultez le guide d'utilisateur du fabricant de votre carte mère, puis connectez ces fils aux connecteurs sur la carte mère.

Connexion USB 2.0 / S'il vous plaît consultez le manuel de votre carte mère à la section "Connexion USB"

Connexion USB 3.0 /

1. Vérifiez que votre carte mère prend en charge la connexion USB 3.0.
2. Connectez le câble USB 3.0 au port USB 3.0 disponible sur votre ordinateur.

Connexion Audio / S'il vous plaît référez vous à l'illustration suivante du connecteur audio et au guide de l'utilisateur de votre carte mère. S'il vous plaît sélectionnez une carte mère supportant AC'97 ou HD Audi (Azalia), (faites attention que votre audio supporte l'AC'97 ou HD Audio (Azalia)) sinon cela pourrait endommager votre matériel.

Español

Guía de Instalación de Cables

Conexión del LED de la caja / En la parte frontal de la caja, encontrará algunos LED y cables de interruptores. Consulte el manual del usuario del fabricante de la placa madre, a continuación conecte estos cables al conector de la placa madre.

Conexión USB 2.0 / Consulte el manual de la placa madre para obtener más información sobre el apartado "Conexión USB"

Conexión USB 3.0 /

1. Asegúrese de que la placa base admite conexión USB 3.0.
2. Conecte el cable USB 3.0 al puerto USB 3.0 disponible en el equipo.

Conexión de Audio / Consulte la siguiente ilustración del conector de Audio y el manual del usuario de la placa madre. Seleccione la placa madre que utiliza AC'97 o HD Audio (Azalia), (asegúrese de que su audio admite AC'97 o HD Audio (Azalia)) si no, sus dispositivos resultarán dañados

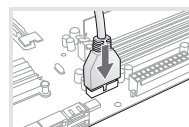

USB 3.0 Connection

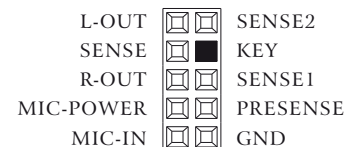

AUDIO AZALIA Function

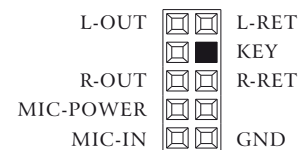

AUDIO AC'97 Function

Italiano

Guida di installazione dei contatti

Connessione del LED del case / Nella parte anteriore del case, sono presenti alcuni contatti per interruttori e LED. Consultare il manuale utente del produttore della scheda madre, quindi connettere i contatti alla parte superiore del pannello sulla scheda madre.

Connessione USB 2.0 / Consultare il manuale per la scheda madre che comprende la sezione relative alla "connessione USB".

Connessione USB 3.0 /

1. Accertarsi che la scheda madre supporti la connessione USB 3.0.
2. Collegare il cavo USB 3.0 alla porta USB 3.0 disponibile sul computer.

Connessione Audio / Fare riferimento all'illustrazione riportata di seguito del connettore Audio e al manuale utente per la scheda madre. Selezionare la scheda madre relativa a AC'97 o HD Audio (Azalia) e considerare che il supporto audio è compatibile con AC'97 o HD Audio (Azalia); in caso contrario, le periferiche potrebbero venire danneggiate.

Português

Guia de Instalação Eléctrica

Ligação do LED da Caixa / Na parte dianteira da caixa pode encontrar alguns LEDs e fios eléctricos. Consulte o manual de utilizador do fabricante da sua motherboard e ligue os fios à parte superior do painel na motherboard.

Ligação UBS 2.0 / Consulte o manual da sua motherboard para ver a secção de "Ligação USB".

Ligação USB 3.0 /

1. Certifique-se que a sua motherboard suporta ligação USB 3.0.
2. Ligue o cabo USB 3.0 à porta USB 3.0 disponível no seu computador.

Ligação Áudio / Consulte a imagem seguinte do conector Áudio e o manual de utilizador da sua motherboard.

Selecione a motherboard que utiliza AC'97 ou HD Áudio (Azalia), (verifique se a sua placa de áudio suporta AC'97 ou HD Áudio (Azalia)) ou irá danificar o(s) seu(s) dispositivo(s).

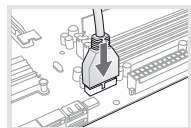
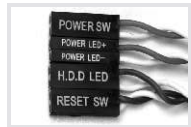

USB 3.0 Connection

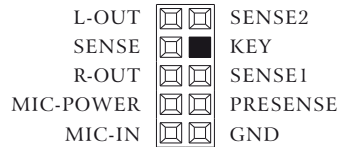

AUDIO AZALIA Function

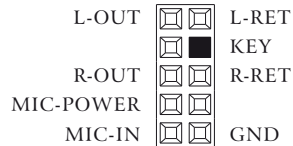

AUDIO AC'97 Function

繁體中文

線材安裝說明

機殼LED連接方式 / 在機殼前方的面板後面，可以找到一些LED與開關線材 (POWER Switch....)，請參考主機板使用說明書，並將機殼上的線材正確地連接到主機板上，這些線材通常都會印有標籤在上面，如果沒有的話，請找出機殼前面板上線材原本的位置以知道正確的來源。

USB 2.0 連接 / 請參考主機板使用手冊找出主機板上的USB連接孔位
USB 3.0 連接 /

1. 請確認主機板是否支援USB 3.0傳輸介面。
 2. 連接USB 3.0傳輸線至主機板上的USB3.0接埠。
- 音效連接 / 請根據下面的音源接頭圖示與主機板使用手冊來連接音效裝置，請確認主機板上的音效裝置是支援AC'97音效或是HD音效(Azalia)，裝置錯誤可能會導致主機板音效裝置的毀損，某些主機板的音效裝置不會與下方的圖示完全相同，請參酌主機板使用手冊以得到正確的安裝資訊

简体中文

线材安装说明

机壳LED连接方式 / 在机壳前方的面板后面，可以找到一些LED与开关线材 (POWER Switch....)，请参考主板使用说明书，并将机壳上的线材正确地连接到主板上，这些线材通常都会印有标签在上面，如果没有的话，请找出机壳前面板上线材原本的位置以知道正确的来源。

USB 2.0 连接 / 请参考主板使用手册找出主板上的USB连接孔位
USB 3.0 连接 /

1. 请确认主板是否支持USB 3.0传输接口。
 2. 连接USB 3.0传输线至主板上的USB3.0接埠。
- 音效连接 / 请根据下面的音源接头图示与主板使用手册来连接音效装置，请确认主板上的音效装置是支持AC'97音效或是HD音效(Azalia)，装置错误可能会导致主板音效装置的毁损，某些主板的音效装置不会与下方的图标完全相同，请参酌主板使用手册以得到正确的安装信息

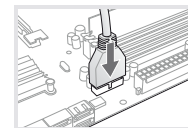
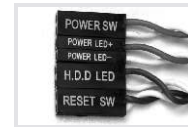

USB 3.0 Connection

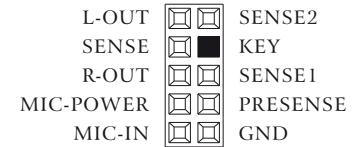

AUDIO AZALIA Function

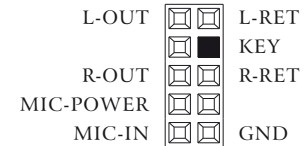

AUDIO AC'97 Function

日本語

リード線の取り付けガイド

ケース LED の接続 / ケース前面には、LEDとスイッチリード線があります。 マザーボードメーカーのユーザーマニュアルを参照し、これらのリード線をマザーボードのパネルヘッダに接続してください。

USB 2.0 の接続 / マザーボードのマニュアルを参照して、「USB接続」のセクションを探します。

USB 3.0 の接続 /

1. お使いのマザーボードがUSB 3.0接続をサポートしていることを確認してください。
2. USB 3.0ケーブルをコンピュータの空いているUSB 3.0ポートに接続します。オーディオ接続 / オーディオコネクタの図とマザーボードのユーザーマニュアルを参照してください。AC'97またはHDオーディオ(Azalia)を使用するマザーボードを選択してください(オーディオがAC'97またはHDオーディオ(Azalia)をサポートしていることを確認してください)。サポートしていないと、デバイスが損傷します。

Русский

Указания по прокладке кабелей

Подключение индикаторов корпуса / В передней части корпуса расположены индикаторы и провода выключателей. Перед подсоединением этих проводов к монтажной колодке панели на материнской плате изучите руководство пользователя производителя материнской платы.

Подключение USB 2.0 / См. раздел «Подключение USB» в руководстве материнской платы.

Подключение USB 3.0 /

1. Убедитесь, что материнская плата поддерживает подключение по стандарту USB 3.0.
 2. Подсоедините кабель USB 3.0 к свободному порту USB 3.0 компьютера.
- Подключение аудиоразъема / См. следующую иллюстрацию аудиоразъема и руководство пользователя материнской платы. Выберите материнскую плату, в которой используется кодек AC'97 или HD Audio (Azalia) (убедитесь, что звуковая плата поддерживает кодек AC'97 или HD Audio (Azalia)). В противном случае можно повредить устройства.

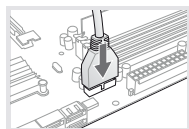
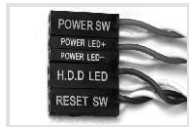

USB 3.0 Connection

L-OUT		SENSE2
SENSE		KEY
R-OUT		SENSE1
MIC-POWER		PRESENSE
MIC-IN		GND

AUDIO AZALIA Function

L-OUT		L-RET
		KEY
R-OUT		R-RET
MIC-POWER		
MIC-IN		GND

AUDIO AC'97 Function

Türkçe

Ara Kablo Kurulum Kılavuzu

Kasa ışık bağlantısı / Kasanın ön kısmında bazı ışıklar ve anahtar ara kabloları görebilirsiniz. Lütfen anakart üreticinizin sağladığı kullanım kılavuzuna bakın ve daha sonra, bu ara kabloları, anakart üzerindeki panel bağlantı noktalarına bağlayın.

USB 2.0 bağlantısı / Lütfen anakart kılavuzunuzun "USB bağlantısı" bölümüne bakın.

USB 3.0 Bağlantısı /

1. Ana kartınızın USB 3.0 bağlantısını desteklediğinden emin olun.
2. USB 3.0 kablosunu, bilgisayarınızdaki kullanılabilir USB 3.0 bağlantı noktasına bağlayın. Ses Bağlantısı / Lütfen aşağıdaki Ses konektörü resmine ve anakartınızın kullanım kılavuzuna bakın. Lütfen AC'97 veya HD Audio(Azalia) spesifikasyonunu kullanan bir anakart seçin (ses sisteminizin AC'97 veya HD Audio (Azalia) spesifikasyonunu desteklediğini unutmayın); aksi takdirde, aygıt(lar)ınız zarar görür.

ภาษาไทย

คู่มือการติดตั้งสายไฟ

การเชื่อมต่อไฟ LED ของเคส / ที่ด้านหน้าของเคส คุณจะเห็นไฟ LED และสายไฟของสวิตช์ กรณีศึกษาสายเคเบิลจะแสดงจากคู่มือผู้ใช้ของผู้ผลิตแผงวงจรหลักของคุณ จากนั้นไฟเชื่อมต่อสายไฟเหล่านี้เข้ากับส่วนหัวของแผงบนแผงวงจรหลัก

การเชื่อมต่อ USB 2.0 / กรุณาศึกษารายละเอียดจากคู่มือผู้ใช้ของผู้ผลิตแผงวงจรหลักของคุณ ในหัวข้อ "การเชื่อมต่อ USB"

การเชื่อมต่อ USB 3.0 /

1. ตรวจสอบให้แน่ใจว่าแผงวงจรหลักของคุณรองรับการเชื่อมต่อ USB 3.0
2. เชื่อมต่อสาย USB 3.0 เข้ากับพอร์ต USB 3.0 ที่สามารถใช้งานได้บนคอมพิวเตอร์ของคุณ การเชื่อมต่ออุปกรณ์รับส่งสัญญาณเสียง/ กรุณาตรวจสอบรายละเอียดจากภาพประกอบของตัวเชื่อมต่อสัญญาณเสียงต่อไป และคู่มือผู้ใช้ของผู้ผลิตแผงวงจรหลักของคุณ กรุณาเลือกแผงวงจรหลักที่ใช้ AC'97 หรือ HD Audio(Azalia) (กรุณาตรวจสอบให้แน่ใจว่าอุปกรณ์รับส่งสัญญาณเสียงของคุณรองรับ AC'97 หรือ HD Audio (Azalia)) มิฉะนั้นอุปกรณ์ของคุณอาจเสียหายได้

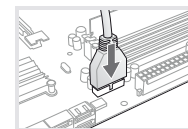

USB 3.0 Connection

L-OUT		SENSE2
SENSE		KEY
R-OUT		SENSE1
MIC-POWER		PRESENSE
MIC-IN		GND

AUDIO AZALIA Function

L-OUT		L-RET
		KEY
R-OUT		R-RET
MIC-POWER		
MIC-IN		GND

AUDIO AC'97 Function