

CATÁLOGO GENERAL 2014

50
aniversario
1964-2014

Tayg

Tayg



BUREAU VERITAS
Certification

Certificación Certification

Concedida a / Awarded to

INDUSTRIAS TAYG SL

AVENIDA REAL DE MADRID NORTE, 70
46469 BENIPARRELL
SPAIN

Bureau Veritas certifica que el Sistema de Gestión ha sido auditado y encontrado conforme con los requisitos de la norma:

Bureau Veritas certify that the Management System has been audited and found to be in accordance with the requirements of standard:

NORMA / STANDARD

ISO 9001:2008

El Sistema de Gestión se aplica a:

Scope of certification:

DISEÑO Y FABRICACIÓN DE ARTÍCULOS DE PLÁSTICO PARA FERRETERÍA Y BRICOLAJE. COMERCIALIZACIÓN DE ARTÍCULOS PARA FERRETERÍA Y BRICOLAJE

DESIGN AND PRODUCTION OF PLASTIC ARTICLES FOR HARDWARE AND D.I.Y. COMMERCIALIZATION OF PRODUCTS FOR HARDWARE AND D.I.Y.

Número del Certificado
Certificate Number

ES042955-1

Director General / General Manager
Bureau Veritas Certification, S.A.

Aprobación original:
Original approval date:

10/07/2009

Certificado en vigor:
Effective date:

11/07/2012

caducidad del certificado:
Certificate expiration date:

10/07/2015

Este certificado está sujeto a los términos y condiciones generales y particulares de los servicios de certificación. This certificate is valid, subject to the general and specific terms and conditions of certification services.



Manejo Oficial Oficina Central: Bureau Veritas Certification, S.A.
Issuing Office Oficina de emisión: Bureau Veritas Certification, S.A.

C/ Valentín Píñeros 22-24, Edificio Coope, Pol. Ind. La Graya, 28109 Alcobendas Madrid



The logo for Tayg, featuring the brand name in a stylized, italicized font with a metallic, 3D effect. The letters are white with a blue and grey gradient and a shadow effect, giving it a modern, industrial feel. The background of the entire page is a dark blue with abstract, glowing circular patterns and lines, suggesting a technical or digital environment.

1 CAJAS DE HERRAMIENTAS

TOOL BOXES

2 PRODUCTOS DE ORDENACIÓN

ARRANGEMENT PRODUCTS

3 ECO TAYG

ECO TAYG

4 ACCESORIOS ELÉCTRICOS

ELECTRIC ACCESSORIES

Desde 1964 en Tayg no dejamos de innovar e invertir en modernas instalaciones y en tecnología punta, aportando las mejores soluciones, un servicio único y la más alta calidad a todos nuestros productos para satisfacer así cada una de las necesidades de nuestros clientes.

Un año más os presentamos nuestro nuevo catálogo 2014 con nuevas colecciones exclusivas diseñadas y desarrolladas por nuestro departamento de I+D siguiendo los requerimientos de nuestros clientes nacionales e internacionales.

Una gran familia que llevamos 50 años encarnando los valores de la marca: elevada profesionalidad y atención al cliente, trato amable, cuidado y personalizado, junto con unas instalaciones que se encuentran entre las mejores de España, contribuyen día a día a que seamos la gran compañía que somos.

Since 1964 Tayg has been constantly innovating and investing in modern facilities and cutting-edge technology, providing the best solutions, a unique service and the highest quality in all our products. Everything in order to satisfy our customer needs.

One more year, we are proud to present you our new 2014 catalogue. It contains new and exclusive collections designed and developed by our I+D team following our national and international customers' requests.

We have become a great family after 50 years highlighting the values of the brand : high commitment in our work, professionalism and an excellent customer service. In addition, we dispose of great facilities being among the best of Europe in our field. All together contributes to maintain our high standards and remain a great company at your service.



Certificación
Concedida a
INDUSTRIAS TAYG, S.L.
VALENCIA
ISO 9001:2008



50 aniversario

1964-2014





TAYG

CAJAS DE
HERRAMIENTAS
TOOL BOXES



1 CAJAS DE HERRAMIENTAS

TOOL BOXES

- 6**
ESTUCHES CON COMPARTIMENTOS FIJOS
BOXES WITH FIXED DISTRIBUTION

- 7**
ESTUCHES CON SEPARADORES FIJOS Y MÓVILES
BOXES WITH FIXED AND MOBILE DIVIDERS

- 8**
ESTUCHES CON SEPARADORES MÓVILES
BOXES WITH MOBILE DIVIDERS





- 9**
ESTUCHES CON SEPARADORES FIJOS Y MÓVILES
BOXES WITH FIXED AND MOBILE DIVIDERS

- 10**
ESTUCHES CON CAJONES EXTRAÍBLES
BOXES WITH REMOVABLE DRAWERS

- 13**
COLECCIÓN HOGAR 30 L
HOME COLLECTION

- 14**
COLECCIÓN HOGAR
HOME COLLECTION

- 16**
MALETAS HERRAMIENTAS ELÉCTRICAS
CASES FOR ELECTRICAL TOOLS

- 17**
MALETINES HERRAMIENTAS MANUALES
CASES FOR MANUAL TOOLS

- 19**
CAJAS HERRAMIENTAS PLÁSTICO
PLASTIC TOOL BOXES

- 26**
CAJAS HERRAMIENTAS PLÁSTICO-ALUMINIO
PLASTIC-ALUMINIUM TOOL BOXES

- 30**
COFRE HERRAMIENTAS MÓVIL
MOBILE TOOL CHEST

- 31**
TRAIL BOX
TRAIL BOX

- 34**
CAJAS HERRAMIENTAS METÁLICAS
METAL TOOL BOXES

- 35**
CARROS TALLER PORTA-HERRAMIENTAS MÓVILES
TOOL TROLLEY

- 36**
BOLSAS HERRAMIENTAS
TOOL BAGS

- 37**
BOLSILLOS HERRAMIENTAS
TOOL POCKET

Estuches con Compartimentos Fijos

Boxes with Fixed Distribution



MODELO MODEL	11-12	11-7	12-21	12-11
CÓDIGO CODE	050107	051104	060106	061103
MEDIDAS SIZES	250 x 140 x 54mm	250 x 140 x 54mm	290 x 195 x 54 mm	290 x 195 x 54 mm
MATERIAL MATERIAL	PP	PP	PP	PP
COLOR COLOUR	Base-Verde Tapa-Transparente Base-Green Cover-Transparent	Base-Verde Tapa-Transparente Base-Green Cover-Transparent	Base-Verde Tapa-Transparente Base-Green Cover-Transparent	Base-Verde Tapa-Transparente Base-Green Cover-Transparent
EMBALAJE PACKING	6 unid.	6 unid.	6 unid.	6 unid.
MEDIDAS EMBALAJE PACKING SIZES	268 x 254 x 170 mm	268 x 254 x 170 mm	300 x 198 x 330 mm	300 x 198 x 330 mm



MODELO MODEL	33-15	33-9	13-32	13-17
CÓDIGO CODE	008009	009006	070105	071102
MEDIDAS SIZES	215 x 207 x 42mm	215 x 207 x 42mm	330 x 247 x 54 mm	330 x 247 x 54 mm
MATERIAL MATERIAL	PP	PP	PP	PP
COLOR COLOUR	Base-Verde Tapa-Transparente Base-Green Cover-Transparent	Base-Verde Tapa-Transparente Base-Green Cover-Transparent	Base-Verde Tapa-Transparente Base-Green Cover-Transparent	Base-Verde Tapa-Transparente Base-Green Cover-Transparent
EMBALAJE PACKING	12 unid.	12 unid.	12 unid.	12 unid.
MEDIDAS EMBALAJE PACKING SIZES	415x220x265 mm	415x220x265 mm	335 x 250 x 330 mm	335 x 250 x 330 mm

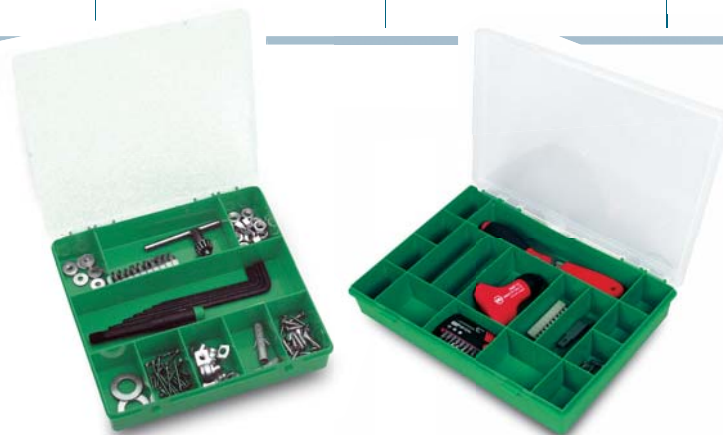

Estuches con Separadores Fijos y M3viles

Boxes with Fixed and Mobile Dividers



MODELO MODEL	170-7	240-12	300-16	450-25	500-25
C3DIGO CODE	012006	013003	014000	010002	011009
MEDIDAS SIZES	170 x 114 x 36 mm	240 x 155 x 41 mm	300 x 199 x 46 mm	387 x 230 x 49 mm	440 x 244 x 49 mm
CONTIENE CONTAINED	—	—	—	Separadores / 10 Dividers	Separadores / 10 Dividers
MATERIAL MATERIAL	PP	PP	PP	PP	PP
COLOR COLOUR	Estuche-Transparente Box-Transparent	Estuche-Transparente Box-Transparent	Estuche-Transparente Box-Transparent	Estuche-Transparente Box-Transparent	Estuche-Transparente Box-Transparent
EMBALAJE PACKING	12 unid.	12 unid.	6 unid.	6 unid.	6 unid.
MEDIDAS EMBALAJE PACKING SIZES	230 x 175 x 225 mm	315 x 242 x 250 mm	302 x 200 x 278 mm	390 x 234 x 300 mm	445 x 248 x 300 mm



MODELO MODEL	23-1	25-1
C3DIGO CODE	004001	006005
MEDIDAS SIZES	160 x 122 x 30 mm	178 x 140 x 34 mm
MATERIAL MATERIAL	PP	PP
COLOR COLOUR	Estuche-Transparente Box-Transparent	Estuche-Transparente Box-Transparent
EMBALAJE PACKING	24 unid.	24 unid.
MEDIDAS EMBALAJE PACKING SIZES	328 x 250 x 195 mm	370 x 284 x 220 mm



Estuches con Separadores Móviles

Boxes with Mobile Dividers



MODELO MODEL	45-26	46-26	47-26	48-26
CÓDIGO CODE	145001	146008	147005	148002
MEDIDAS SIZES	312 x 238 x 51 mm	378 x 290 x 61 mm	460 x 350 x 81 mm	460 x 350 x 81 mm
CONTIENE CONTAINED	Separadores / 21 Dividers	Separadores / 21 Dividers	Separadores / 21 Dividers	Separadores / 21 Dividers
MATERIAL MATERIAL	PP	PP	PP	Base, separadores y cierres-PP. Tapa-POLICARBONATO (PC)
COLOR COLOUR	Base-Azul Tapa-Transparente Separadores-Amarillos Base-Blue Cover-Transparent Dividers-Yellow	Base-Azul Tapa-Transparente Separadores-Amarillos Base-Blue Cover-Transparent Dividers-Yellow	Base-Azul Tapa-Transparente Separadores-Amarillos Base-Blue Cover-Transparent Dividers-Yellow	Base-Negro Tapa-Transparente Separadores-Rojos Base-Black Cover-Transparent Dividers-Red
EMBALAJE PACKING	6 unid.	6 unid.	5 unid.	5 unid.
MEDIDAS EMBALAJE PACKING SIZES	314 x 244 x 310 mm	382 x 294 x 370 mm	405 x 356 x 470 mm	405 x 356 x 470 mm



Estuches con Separadores Fijos y M3viles

Boxes with Fixed and Mobile Dividers



MODELO MODEL	20-9	21-10	22-26	23-26	24-26
C3DIGO CODE	020001	021008	022005	023002	024009
MEDIDAS SIZES	190 x 150 x 42 mm	256 x 192 x 42 mm	312 x 238 x 51 mm	388 x 290 x 61 mm	460 x 350 x 81 mm
CONTIENE CONTAINED	—	—	Separadores / 21 Dividers	Separadores / 21 Dividers	Separadores / 21 Dividers
MATERIAL MATERIAL	PP	PP	PP	PP	PP
COLOR COLOUR	Base-Verde Tapa-Transparente Base-Green Cover-Transparent	Base-Verde Tapa-Transparente Base-Green Cover-Transparent	Base-Verde Tapa-Transparente Separadores-Amarillos Base-Green Cover-Transparent Dividers-Yellow	Base-Verde Tapa-Transparente Separadores-Amarillos Base-Green Cover-Transparent Dividers-Yellow	Base-Verde Tapa-Transparente Separadores-Amarillos Base-Green Cover-Transparent Dividers-Yellow
EMBALAJE PACKING	12 unid.	12 unid.	6 unid.	6 unid.	5 unid.
MEDIDAS EMBALAJE PACKING SIZES	300 x 192 x 253 mm	390 x 265 x 260 mm	310 x 244 x 320 mm	392 x 294 x 370 mm	405 x 356 x 470 mm



Estuches con Cajones Extraíbles 50

Boxes with Removable Drawers 50

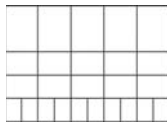
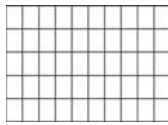

MODELO MODEL	430/50/50	430/50/25	430/50/0
CÓDIGO CODE	030000	031007	030406
MEDIDAS SIZES	430 x 370 x 55 mm	430 x 370 x 55 mm	430 x 370 x 55 mm
CONTIENE CONTAINED	Cajones 50/A50 Boxes	Cajones 10/A50 Boxes 10/B50 5/C50	Vacío Empty
MATERIAL MATERIAL	Base PP Base Tapa PS Cover Cajones PS Boxes	Base PP Base Tapa PS Cover Cajones PS Boxes	Base PP Base Tapa PS Cover
COLOR COLOUR	Base-Negro Tapa-Transparente Cajones-Rojos Base-Black Cover-Transparent Boxes-Red	Base-Negro Tapa-Transparente Cajones-Rojos Base-Black Cover-Transparent Boxes-Red	Base-Negro Tapa-Transparente Base-Black Cover-Transparent
EMBALAJE PACKING	4 unid.	4 unid.	4 unid.
MEDIDAS EMBALAJE PACKING SIZES	435 x 378 x 222 mm	435 x 378 x 222 mm	435 x 378 x 222 mm



Cajones Extraíbles

Removable Drawers



MODELO MODEL	A50	B50	C50
CÓDIGO CODE	040009	041006	042003
MEDIDAS SIZES	55 x 39 x 47 mm	79 x 55 x 47 mm	109 x 79 x 47 mm
EMBALAJE PACKING	300	150	75
MEDIDAS EMBALAJE PACKING SIZES	405 x 340 x 245 mm	405 x 340 x 245 mm	405 x 340 x 245 mm

Estuches con Cajones Extraíbles 80

Boxes with Removable Drawers 80

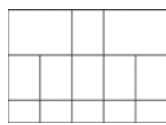
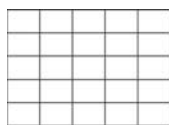

MODELO MODEL	430/80/25	430/80/13	430/80/0
CÓDIGO CODE	032004	033001	032400
MEDIDAS SIZES	430 x 370 x 85 mm	430 x 370 x 85 mm	430 x 370 x 85 mm
CONTIENE CONTAINED	Cajones 25/B80 Boxes	Cajones 5/B80 6/C80 2/D80 Boxes	Vacío Empty
MATERIAL MATERIAL	Base PP Base Tapa PS Cover Cajones PS Boxes	Base PP Base Tapa PS Cover Cajones PS Boxes	Base PP Base Tapa PS Cover
COLOR COLOUR	Base-Negro Tapa-Transparente Cajones-Rojos Base-Black Cover-Transparent Boxes-Red	Base-Negro Tapa-Transparente Cajones-Rojos Base-Black Cover-Transparent Boxes-Red	Base-Negro Tapa-Transparente Base-Black Cover-Transparent
EMBALAJE PACKING	4 unid.	4 unid.	4 unid.
MEDIDAS EMBALAJE PACKING SIZES	435 x 378 x 338 mm	435 x 378 x 338 mm	435 x 378 x 338= mm

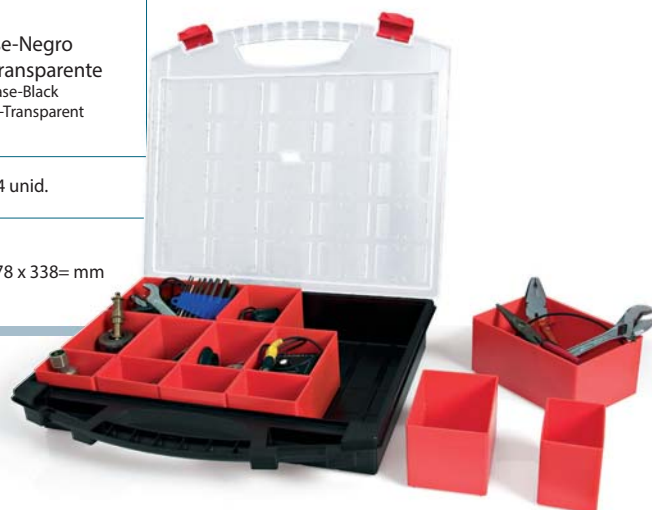

Cajones Extraíbles

Removable Drawers



MODELO MODEL	B80	C80	D80
CÓDIGO CODE	043000	044007	045004
MEDIDAS SIZES	79 x 55 x 76 mm	109 x 79 x 76 mm	157 x 109 x 76 mm
EMBALAJE PACKING	90	45	21
MEDIDAS EMBALAJE PACKING SIZES	405 x 340 x 245 mm	405 x 340 x 245 mm	405 x 340 x 245 mm

Estuches con Cajones Extraíbles

Boxes with Removable Drawers

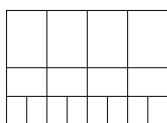

MODELO MODEL	330/50/32	330/50/16	330/50/0
CÓDIGO CODE	034008	035005	034404
MEDIDAS SIZES	330 x 247 x 54 mm	330 x 247 x 54 mm	330 x 247 x 54 mm
CONTIENE CONTAINED	Cajones 32/A50 Boxes	Cajones 8/A50 Boxes 4/B50 4/C50	Cajones Vacío Boxes Empty
MATERIAL MATERIAL	Base PP Base Tapa PP Cover Cajones PS Boxes	Base PP Base Tapa PP Cover Cajones PS Boxes	Base PP Base Tapa PP Cover
COLOR COLOUR	Base-Negro Tapa-Transparente Cajones-Rojos Base-Black Cover-Transparent Boxes-Red	Base-Negro Tapa-Transparente Cajones-Rojos Base-Black Cover-Transparent Boxes-Red	Base-Negro Tapa-Transparente Base-Black Cover-Transparent
EMBALAJE PACKING	6 unid.	6 unid.	6 unid.
MEDIDAS EMBALAJE PACKING SIZES	335 x 250 x 330 mm	335 x 250 x 330 mm	335 x 250 x 330 mm



Colección Hogar 30 l.

Home Collection 30 l.



MODELO MODEL	eco Tayg azul home collection	eco Tayg rosa home collection
CÓDIGO CODE	416590	417597
MEDIDAS SIZES	392 x 399 x 330 mm	392 x 399 x 330 mm
CAPACIDAD CAPACITY	30 l.	30 l.
MATERIAL	PP	PP
COLOR COLOUR	azul	rosa
EMBALAJE PACKING	5 unid.	5 unid.
MEDIDAS EMBALAJE PACKING SIZES	418 x 404 x 472 mm	418 x 404 x 472 mm



Colección Hogar

Home Collection

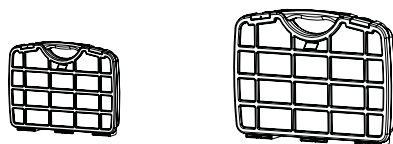

MODELO MODEL	22	23
CÓDIGO CODE	022593	023590
MEDIDAS SIZES	312 x 238 x 51 mm	388 x 290 x 61 mm
CONTIENE CONTAINED	Separadores 21 Dividers	Separadores 21 Dividers
COLOR COLOUR	Base Transparente Accesorios Azul Base-Transparent Accessories-Blue	Base Transparente Accesorios Azul Base-Transparent Accessories-Blue
MATERIAL MATERIAL	PP	PP
EMBALAJE PACKING	6 unid.	6 unid.
MEDIDAS EMBALAJE PACKING SIZES	310 x 244 x 320 mm	392 x 294 x 370 mm



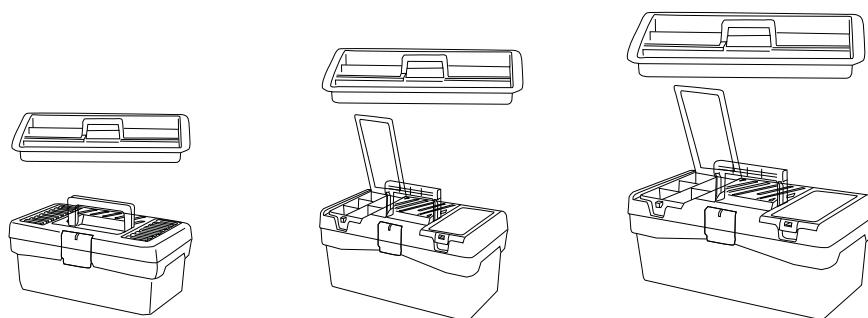

MODELO MODEL	12"	14"	16"
CÓDIGO CODE	110597	111594	112591
MEDIDAS SIZES	290 x 170 x 127 mm	356 x 192 x 150 mm	400 x 217 x 166 mm
CONTIENE CONTAINED	Bandeja Tray	Bandeja Tray	Bandeja Tray
COLOR COLOUR	Base-Transparente Accesorios-Azul Base-Transparent Accessories-Blue	Base-Transparente Accesorios-Azul Base-Transparent Accessories-Blue	Base-Transparente Accesorios-Azul Base-Transparent Accessories-Blue
MATERIAL MATERIAL	PP	PP	PP
EMBALAJE PACKING	10 unid.	6 unid.	6 unid.
MEDIDAS EMBALAJE PACKING SIZES	780 x 294 x 260 mm	365 x 360 x 463 mm	600 x 404 x 340 mm



Maletas Herramientas Eléctricas

Cases for Electrical Tools



MODELO MODEL	43
CÓDIGO CODE	143007
MEDIDAS SIZES	401 x 352 x 156 mm
CONTIENE CONTAINED	Separadores 20 Dividers
MATERIAL MATERIAL	PP
COLOR COLOUR	Azul-Separadores Amarillos Tapa Transparente Base-Blue Yellow dividers
EMBALAJE PACKING	6 unid.
MEDIDAS EMBALAJE PACKING SIZES	708 x 404 x 474 mm



Maletas Herramientas Eléctricas

Cases for Electrical Tools

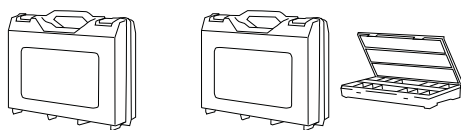

MODELO MODEL	40	41
CÓDIGO CODE	140006	141003
MEDIDAS SIZES	385 x 330 x 130 mm	385 x 330 x 130 mm
CONTIENE CONTAINED	Vacio Empty	Estuche 1 Box
MATERIAL MATERIAL	PP	PP
COLOR COLOUR	Caja-Azul Box-Blue	Caja-Azul Estuche-Rojo Box-Blue Box-Red
EMBALAJE PACKING	7 unid.	7 unid.
MEDIDAS EMBALAJE PACKING SIZES	795 x 390 x 398 mm	795 x 390 x 398 mm



Maletas Herramientas Manuales

Cases for Manual Tools

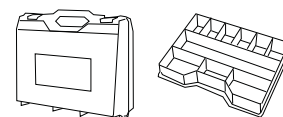

MODELO MODEL	42
CÓDIGO CODE	142000
MEDIDAS SIZES	385 x 330 x 130 mm
CONTIENE CONTAINED	Bandeja 1 Tray
MATERIAL MATERIAL	PP
COLOR COLOUR	Base-Azul Tapa Transparente Bandeja-Amarilla Base-Green Cover-Transparent Tray-Yellow
EMBALAJE PACKING	7 unid.
MEDIDAS EMBALAJE PACKING SIZES	795 x 390 x 398 mm

Maletas Herramientas Eléctricas

Cases for Electrical Tools



MODELO MODEL	44	44-B
CÓDIGO CODE	144004	144998
MEDIDAS SIZES	430 x 370 x 140 mm	430 x 370 x 140 mm
CONTIENE CONTAINED	Vacio Empty	Bandeja Tray
MATERIAL MATERIAL	PP	PP
COLOR COLOUR	Caja-Negro Cierre-Rojo Box-Black Locks-Red	Base-Negro Tapa-Transparente Bandeja-Rojo Cierre-Rojo Base-Black Cover-Transparent Tray-Red Locks-Red
EMBALAJE PACKING	4 unid.	4 unid.
MEDIDAS EMBALAJE PACKING SIZES	432 x 380 x 568 mm	432 x 380 x 568 mm



Cajas Herramientas Plástico

Plastic Tool Boxes

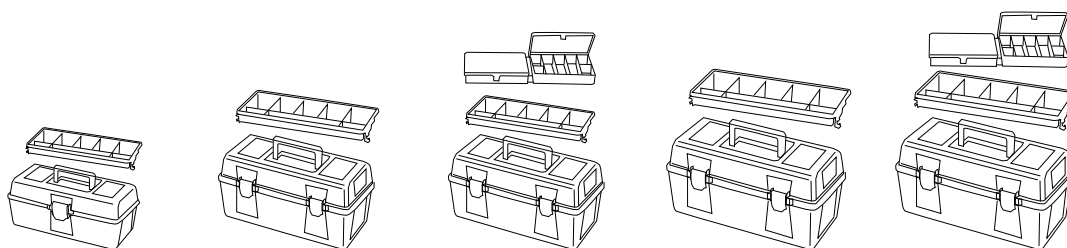

MODELO MODEL	21	22	23	24	25
CÓDIGO CODE	121005	122002	123009	124006	125003
MEDIDAS SIZES	310 x 160 x 130 mm	356 x 184 x 163 mm	356 x 184 x 163 mm	400 x 206 x 188 mm	400 x 206 x 188 mm
CONTIENE CONTAINED	Bandeja 1 Tray	Bandeja 1 Tray	Bandeja 1 Tray Estuche 1 Box	Bandeja 1 Tray	Bandeja 1 Tray Estuche 1 Box
MATERIAL MATERIAL	PP	PP	PP	PP	PP
COLOR COLOUR	Caja-Azul Bandeja-Rojo Box-Blue Tray-Red	Caja-Azul Bandeja-Rojo Box-Blue Tray-Red	Caja-Azul Bandeja-Rojo Estuche-Transparente Box-Blue Tray-Red Box-Transparent	Caja-Azul Bandeja-Rojo Box-Blue Tray-Red	Caja-Azul Bandeja-Rojo Estuche-Transparente Box-Blue Tray-Red Box-Transparent
EMBALAJE PACKING	10 unid.	6 unid.	6 unid.	6 unid.	6 unid.
MEDIDAS EMBALAJE PACKING SIZES	790 x 314 x 260 mm	555 x 360 x 335 mm	555 x 360 x 335 mm	600 x 404 x 385 mm	600 x 404 x 385 mm



Cajas Herramientas Plástico

Plastic Tool Boxes

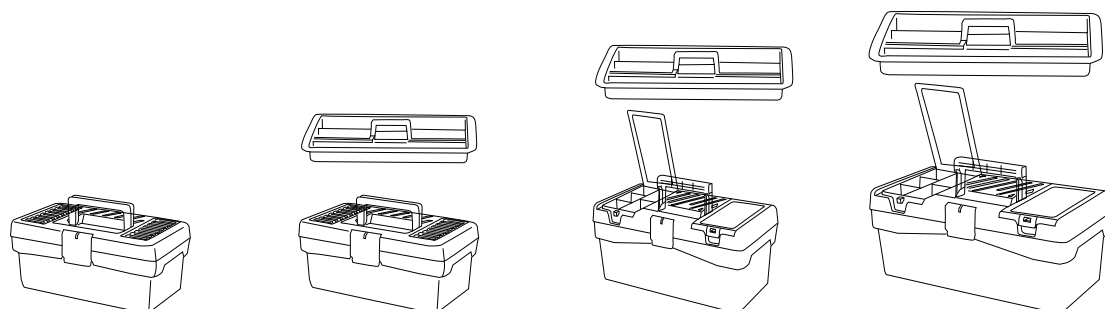

MODELO MODEL	9	10	11	12
CÓDIGO CODE	109003	110009	111006	112003
MEDIDAS SIZES	290 x 170 x 127 mm	290 x 170 x 127 mm	356 x 192 x 150 mm	400 x 217 x 166 mm
CONTIENE CONTAINED	Vacia Empty	Bandeja 1 Tray	Bandeja 1 Tray	Bandeja 1 Tray
MATERIAL MATERIAL	PP	PP	PP	PP
COLOR COLOUR	Caja-Azul Box-Blue	Caja-Azul Bandeja-Rojo Box-Blue Tray-Red	Caja-Azul Bandeja-Rojo Box-Blue Tray-Red	Caja-Azul Bandeja-Rojo Box-Blue Tray-Red
EMBALAJE PACKING	10 unid.	10 unid.	6 unid.	6 unid.
EMBALAJE PACKING SIZES	780 x 294 x 260 mm	780 x 294 x 260 mm	365 x 360 x 463 mm	600 x 404 x 340 mm



Cajas Herramientas Plástico

Plastic Tool Boxes

BANDEJA CON DOBLE CAPACIDAD

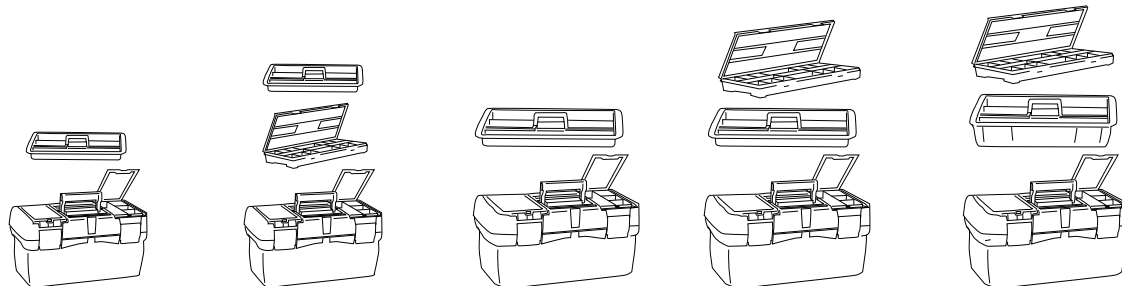

MODELO MODEL	15	16	17	18	19
CÓDIGO CODE	115004	116001	117008	118005	119002
MEDIDAS SIZES	500 x 258 x 255mm	500 x 258 x 255mm	580 x 290 x 290mm	580 x 290 x 290mm	580 x 290 x 290mm
CONTIENE CONTAINED	Bandeja 1 Tray	Bandeja 1 Tray Estuche 1 Box	Bandeja 1 Tray	Bandeja 1 Tray Estuche 1 Box	Bandeja 1 Tray Estuche 1 Box
MATERIAL MATERIAL	PP Cierres metálicos Metallics locks	PP Cierres metálicos Metallics locks	PP Cierres metálicos Metallics locks	PP Cierres metálicos Metallics locks	PP Cierres metálicos Metallics locks
COLOR COLOUR	Caja-Azul Bandeja-Rojo Box-Blue Tray-Red	Caja-Azul Bandeja-Rojo Estuche-Rojo Box-Blue Tray-Red Box-Red	Caja-Azul Bandeja-Rojo Box-Blue Tray-Red	Caja-Azul Bandeja-Rojo Estuche-Rojo Box-Blue Tray-Red Box-Red	Caja-Azul Bandeja-Rojo Estuche-Rojo Box-Blue Tray-Red Box-Red
EMBALAJE PACKING	3 unid.	3 unid.	3 unid.	3 unid.	3 unid.
EMBALAJE PACKING SIZES	720 x 264 x 510 mm	720 x 264 x 510 mm	795 x 290 x 584 mm	795 x 290 x 584 mm	795 x 290 x 584 mm
UNIDAD BOX PALET BOX - PALET UNIT	24	24	24	24	24
MEDIDAS BOX PALET BOX - PALET SIZE	1000 x 772 x 1016 mm	1000 x 772 x 1016 mm	1160 x 804 x 1160 mm	1160 x 804 x 1160 mm	1160 x 804 x 1160 mm

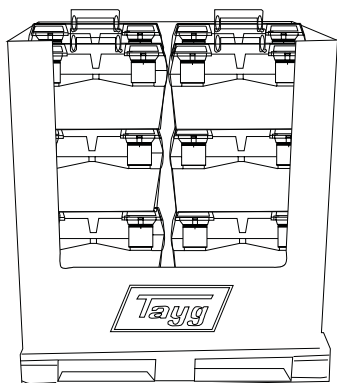

OPCIÓN BOX PALET
BOX - PALET OPTION



Cajas Herramientas Plástico

Plastic Tool Boxes



Cajas Herramientas Plástico

Plastic Tool Boxes

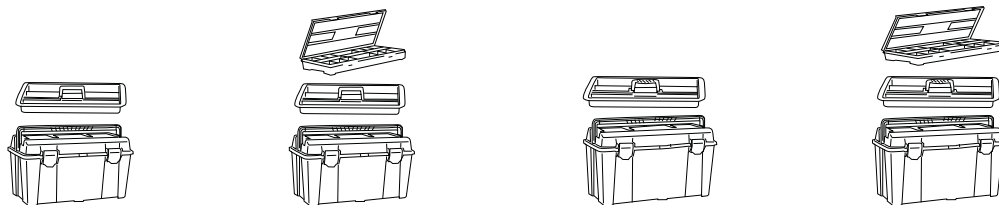

MODELO MODEL	30	31	32	33
CÓDIGO CODE	130007	131004	132001	133008
MEDIDAS SIZES	445 x 235 x 230 mm	445 x 235 x 230 mm	480 x 258 x 255 mm	480 x 258 x 255 mm
CONTIENE CONTAINED	Bandeja 1 Tray	Bandeja 1 Tray Estuche 1 Box	Bandeja 1 Tray	Bandeja 1 Tray Estuche 1 Box
MATERIAL MATERIAL	PP	PP	PP	PP
COLOR COLOUR	Caja-Negro Bandeja-Rojo Box-Black Tray-Red	Caja-Negro Bandeja-Rojo Estuche-Rojo Box-Black Tray-Red Box-Red	Caja-Negro Bandeja-Rojo Box-Black Tray-Red	Caja-Negro Bandeja-Rojo Estuche-Rojo Box-Black Tray-Red Box-Red
EMBALAJE PACKING	6 unid.	6 unid.	3 unid.	3 unid.
MEDIDAS EMBALAJE PACKING SIZES	670 x 450 x 470 mm	670 x 450 x 470 mm	730 x 485 x 264 mm	730 x 485 x 264 mm



Cajas Herramientas Plástico

Plastic Tool Boxes

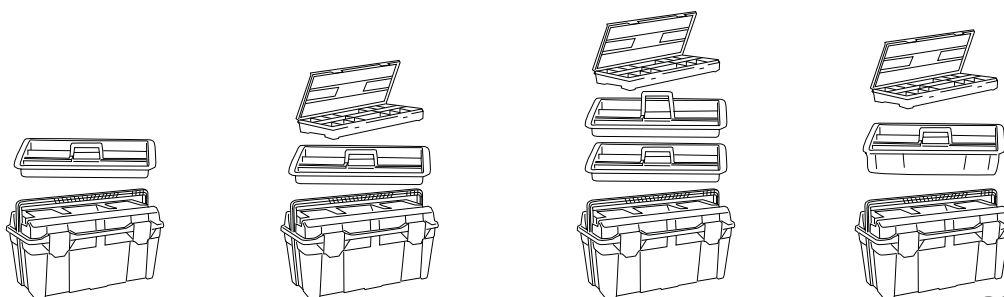

BANDEJA CON DOBLE CAPACIDAD

MODELO MODEL	34-1B	34	35	36
CÓDIGO CODE	134999	134005	135002	136009
MEDIDAS SIZES	580 x 285 x 290 mm	580 x 285 x 290 mm	580 x 285 x 290 mm	580 x 285 x 290 mm
CONTIENE CONTAINED	Bandeja 1 Tray	Bandeja 1 Tray Estuche 1 Box	Bandeja 2 Tray Estuche 1 Box	Bandeja 1 Tray Estuche 1 Box
MATERIAL	PP	PP	PP	PP
COLOR COLOUR	Caja-Negro Bandeja-Rojo Box-Black Tray-Red	Caja-Negro Bandeja-Rojo Estuche-Rojo Box-Black Tray-Red Box-Red	Caja-Negro Bandeja-Rojo Estuche-Rojo Box-Black Tray-Red Box-Red	Caja-Negro Bandeja-Rojo Estuche-Rojo Box-Black Tray-Red Box-Red
EMBALAJE PACKING	3 unid.	3 unid.	3 unid.	3 unid.
MEDIDAS EMBALAJE PACKING SIZES	795 x 290 x 584 mm	795 x 290 x 584 mm	795 x 290 x 584 mm	795 x 290 x 584 mm



149009 ACCESORIO-CINTA Y SOPORTES
ACCESSORY-STRAP, FRAME

Cajas de Herramientas Plástico-Aluminio

Plastic-Aluminium Tool Boxes

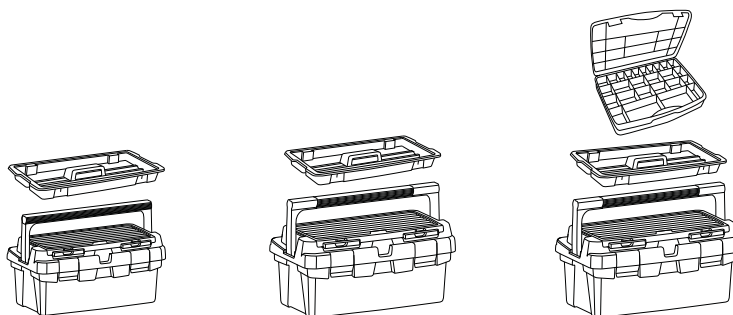

MODELO MODEL	400	450	450-E
CÓDIGO CODE	162008	163005	164002
MEDIDAS SIZES	400x225x190 mm	450x285x250 mm	450x285x250 mm
CONTIENE CONTAINED	Bandeja 1 Tray	Bandeja 1 Tray	Bandeja 1 Tray Estuche 1 Box
MATERIAL MATERIAL	PP	PP Asa Aluminio Aluminium handle Cierres metálicos Metallic locks	PP Asa Aluminio Aluminium handle Cierres metálicos Metallic locks
COLOR COLOUR	Caja-Negro Bandeja-Rojo Box-Black Tray-Red	Caja-Negro Bandeja-Rojo Box-Black Tray-Red	Caja-Negro Bandeja-Rojo Estuche-Transparente Box-Black Tray-Red Box-Transparent
EMBALAJE PACKING	6 unid.	3 unid.	3 unid.
MEDIDAS EMBALAJE PACKING SIZES	625x402x388 mm	790x254x455 mm	790x254x455 mm



Cajas de Herramientas Plástico-Aluminio

Plastic-Aluminium Tool Boxes

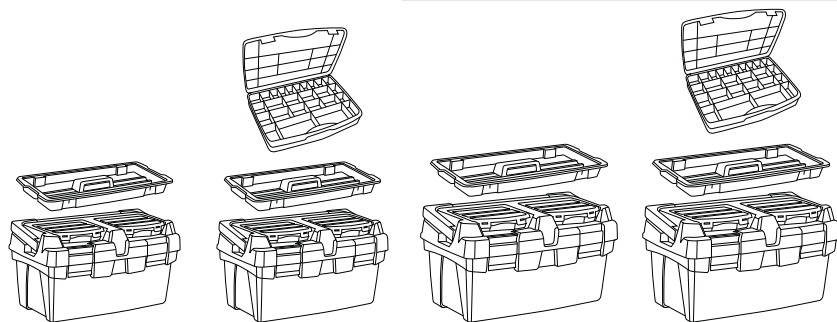

MODELO MODEL	500	500-E	600	600-E
CÓDIGO CODE	165009	166006	167003	168000
MEDIDAS SIZES	500x295x270 mm	500x295x270 mm	600x305x295 mm	600x305x295 mm
CONTIENE CONTAINED	Bandeja 1 Tray	Bandeja 1 Tray Estuche 1 Box	Bandeja 1 Tray	Bandeja 1 Tray Estuche 1 Box
MATERIAL MATERIAL	PP Asa Aluminio Aluminium handle Cierres metálicos Metallic locks	PP Asa Aluminio Aluminium handle Cierres metálicos Metallic locks	PP Asa Aluminio Aluminium handle Cierres metálicos Metallic locks	PP Asa Aluminio Aluminium handle Cierres metálicos Metallic locks
COLOR COLOUR	Caja-Negro Bandeja-Rojo Box-Black Tray-Red	Caja-Negro Bandeja-Rojo Estuche-Transparente Box-Black Tray-Red Box-Transparent	Caja-Negro Bandeja-Rojo Box-Black Tray-Red t	Caja-Negro Bandeja-Rojo Estuche-Transparente Box-Black Tray-Red Box-Transparent
EMBALAJE PACKING	3 unid.	3 unid.	3 unid.	3 unid.
MEDIDAS EMBALAJE PACKING SIZES	825x274x505 mm	825x274x505 mm	840x300x605 mm	840x300x605 mm



Cajas de Herramientas Colección Básica

Basic Collection Tool Boxes



MODELO MODEL	AccessoryBox 01	AccessoryBox 02	AccessoryBox 03	Power tools 43
CÓDIGO CODE	022555	023552	024559	143557
MEDIDAS SIZES	312x238x51 mm	388x290x61 mm	460x350x81 mm	401x352x156 mm
CONTIENE CONTAINED	21 Separadores 21 Dividers	21 Separadores 21 Dividers	21 Separadores 21 Dividers	20 Separadores 20 Dividers
EMBALAJE PACKING	6 unid.	6 unid.	5 unid.	6 unid.
MEDIDAS EMBALAJE PACKING SIZES	310x244x320 mm	392x294x370 mm	405x356x470 mm	708x404x474 mm
CANTIDAD MÍNIMA MINIMUM QUANTITY	462 unid.	288 unid.	150 unid.	90 unid.
MEDIDAS PALET PALET SIZE	1200x800x2400 mm	1200x800x2400 mm	1200 x 800 x 2510	1200 x 810 x 2530



Cajas de Herramientas Colección Básica

Basic Collection Tool Boxes



MODELO MODEL	ToolBox 12"	ToolBox 16"	ToolBox 20"	ToolBox 23"
CÓDIGO CODE	110559	112553	115554	117558
MEDIDAS SIZES	290x170x127 mm	400x217x166 mm	500x258x255 mm	580x290x290 mm
CONTIENE CONTAINED	Bandeja 1 1 Tray	Bandeja 1 1 Tray	Bandeja 1 1 Tray	Bandeja 1 1 Tray
EMBALAJE PACKING	10 unid.	6 unid.	3 unid.	3 unid.
MEDIDAS EMBALAJE PACKING SIZES	780 x 294 x 260 mm	600 x 404 x 340 mm	720 x 264 x 510 mm	795 x 290 x 584 mm
CANTIDAD MÍNIMA MINIMUM QUANTITY	360 unid.	168 unid.	54 unid.	48 unid.
MEDIDAS PALET PALET SIZE	1200x800x2500 mm	1210x810x2530 mm	1200x800x2530 mm	1200x800x2470 mm



Cofre Herramientas Móvil

Mobile Tool Chest

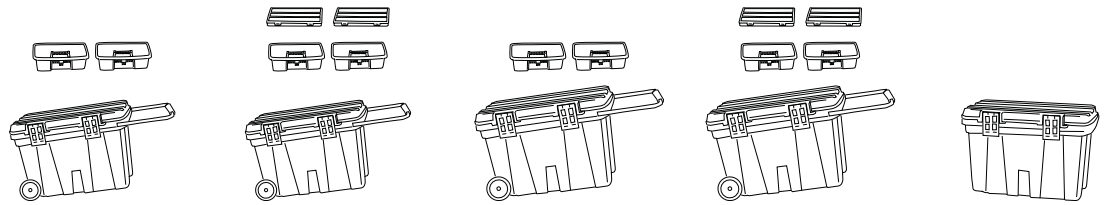

MODELO MODEL	50	51	53	54	56
CÓDIGO CODE	150005	151002	153006	154003	156007
MEDIDAS SIZES	675x472x416 mm	675x472x416 mm	775x472x493 mm	775x472x493 mm	740x472x493 mm
CONTIENE CONTAINED	Bandeja 2 Tray Palomillas 5 Small Bracket	Bandeja 2 Tray Estuches 2 Boxes	Bandeja 2 Tray Palomillas 5 Small Bracket	Bandeja 2 Tray Estuches 2 Boxes	Vacío Empty
MATERIAL MATERIAL	PP	PP	PP	PP	PP
COLOR COLOUR	Base-Negro Tapa-Negro Bandeja-Rojo Palomillas-Rojo Base-Black Cover-Black Tray-Red Small Brackets-Red	Base-Negro Tapa-Negro Bandeja-Rojo Estuche-Rojo Base-Black Cover-Black Tray-Red Box-Red	Base-Negro Tapa-Negro Bandeja-Rojo Palomillas-Rojo Base-Black Cover-Black Tray-Red Small Brackets-Red	Base-Negro Tapa-Negro Bandeja-Rojo Estuche-Rojo Base-Black Cover-Black Tray-Red Box-Red	Base-Negro Tapa-Negro Base-Black Cover-Black
EMBALAJE PACKING	1 unid.	1 unid.	1 unid.	1 unid.	2 unid.
MEDIDAS EMBALAJE PACKING SIZES	680x480x430 mm	680x480x430 mm	775x480x500 mm	775x480x500 mm	746x480x610 mm



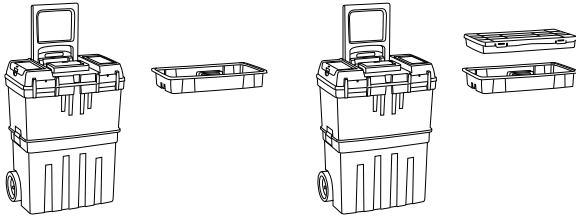

MODELO MODEL	57	58
CÓDIGO CODE	157004	158001
MEDIDAS SIZES	470x290x630 mm	470x290x630 mm
CONTIENE CONTAINED	Bandeja 1 Tray	Bandeja 1 Tray Estuches 1 Boxes
MATERIAL MATERIAL	PP	PP Cierres metálicos Metallic locks
COLOR COLOUR	Base-Negro Tapa-Negro Bandeja-Rojo Rueda-Negra Base-Black Cover-Black Tray-Red Wheel-Black	Base-Negro Tapa-Negro Bandeja-Rojo Estuche-Transparente Rueda-Negra/Rojo Base-Black Cover-Black Tray-Red Box-Transparent Wheel-Black/Red
EMBALAJE PACKING	1 unid.	1 unid.
MEDIDAS EMBALAJE PACKING SIZES	476x296x640 mm	476x296x640 mm



Trail Box

Trail Box



MODELO MODEL	59
CÓDIGO CODE	159008
MEDIDAS SIZES	500x410x770 mm
CONTIENE CONTAINED	1 estuche 430/50/25 1 estuche 430/80/13 1 estuche 430/80/0 1 maleta 44B 1 maleta cajón
MATERIAL MATERIAL	pp Cajones y tapa transparente-PS
COLOR COLOUR	Armazón-Negro Puerta-Roja Rueda Negra/Roja
EMBALAJE PACKING	1 unid.
MEDIDAS EMBALAJE PACKING SIZES	510x410x775 mm



TRAIL BOX PROF



Cajas Herramientas Metálicas

Metal Tool Boxes



MODELO MODEL	403	405	503	505
CÓDIGO CODE	185007	186004	187001	188008
MEDIDAS SIZES	404x200x240 mm	404x200x290 mm	500x200x240 mm	500x200x290 mm
DEPARTAMENTOS CONTAINED	3	5	3	3
COLOR COLOUR	Rojo Red	Rojo Red	Rojo Red	Rojo Red
MATERIAL MATERIAL	Chapa de acero Pintura epoxi Steel Sheet	Chapa de acero Pintura epoxi Steel Sheet	Chapa de acero Pintura epoxi Steel Sheet	Chapa de acero Pintura epoxi Steel Sheet
EMBALAJE PACKING	1 unid.	1 unid.	1 unid.	1 unid.
MEDIDAS EMBALAJE PACKING SIZES	450x220x276 mm	450x220x325 mm	545x230x276 mm	545x230x325 mm



Carros de Taller Porta-Herramientas Móviles

Tool Trolley



MODELO MODEL	CT-0	CT-1	CT-2	CT-5
CÓDIGO CODE	194009	190001	193002	191008
MEDIDAS SIZES	820x365x900 mm	935x385x985 mm	735x370x835 mm	750x460x850 mm
CAJONES Y MEDIDAS DRAWERS & SIZES	0	1	2	2 (582x382x125) 3 (582x382x55)
MATERIAL MATERIAL	Chapa de acero Pintura epoxi Steel Sheet	Chapa de acero Pintura epoxi Steel Sheet	Chapa de acero Pintura epoxi Steel Sheet	Chapa de acero Pintura epoxi Steel Sheet
PESO WEIGHT	14 kg	24 kg	28 kg	43 kg
COLOR COLOUR	Rojo Red	Rojo/Cajón Negro Red/ Black drawer	Rojo/Cajones Negro Red/ Black drawers	Rojo/Cajones Negro Red/ Black drawers
EMBALAJE PACKING	1 unid.	1 unid.	1 unid.	1 unid.
MEDIDAS EMBALAJE PACKING SIZES	780x420x160 mm	800x435x380 mm	785x440x425 mm	749x520x780 mm



Ruedas

Casters



CÓDIGO CODE	195006	196003	197000
CONTIENE CONTAINED	2 ruedas móviles con freno 2 ruedas fijas Tornillería 2 Mobile casters with brake 2 Fixed casters Screws	2 ruedas móviles con freno 2 ruedas fijas Tornillería 2 Mobile casters with brake 2 Fixed casters Screws	2 ruedas móviles con freno 2 ruedas fijas Tornillería 2 Mobile casters with brake 2 Fixed casters Screws
VÁLIDO PARA VALID FOR	CT0-CT1	CT2	CT5

Bolsas de Herramientas

Tool Bags



Con 4 tacos de apoyo en el fondo.
With 4 rubber feet the bottom.

MODELO MODEL	Bolsa Herramientas BN-1 (13") Nylon Tool Bag BN-1(13")
CÓDIGO CODE	080005
MEDIDAS SIZES	345x220x225 mm
MATERIAL MATERIAL	Nylon Nylon
COLOR COLOUR	Negro y Rojo Black & Red
EMBALAJE PACKING	6 unid. 6 pcs.
MEDIDAS EMBALAJE PACKING SIZES	345x230x320 mm



MODELO MODEL	Bolsa Herramientas BN-3 (18") Nylon Tool Bag BN-3(18")
CÓDIGO CODE	082009
MEDIDAS SIZES	455x250x265 mm
MATERIAL MATERIAL	Bolsa Nylon-Fondo Polieteno Nylon Bag-Base Polytene
COLOR COLOUR	Negro y Rojo Black & Red
EMBALAJE PACKING	6 unid. 6 pcs.
MEDIDAS EMBALAJE PACKING SIZES	480x260x400 mm



MODELO MODEL	Bolsa Herramientas BN-5 (13") Nylon Tool Bag BN-5(13")
CÓDIGO CODE	095009
MEDIDAS SIZES	335x200x290 mm
MATERIAL MATERIAL	Nylon Nylon
COLOR COLOUR	Negro y Rojo Black & Red
EMBALAJE PACKING	6 unid. 6 pcs.
MEDIDAS EMBALAJE PACKING SIZES	510x340x250 mm



MODELO MODEL	Bolsa Herramientas BN-6 (17") Nylon Tool Bag BN-6(17")
CÓDIGO CODE	096006
MEDIDAS SIZES	420x220x290 mm
MATERIAL MATERIAL	Nylon Nylon
COLOR COLOUR	Negro y Rojo Black & Red
EMBALAJE PACKING	6 unid. 6 pcs.
MEDIDAS EMBALAJE PACKING SIZES	510x435x250 mm

Bolsillos Herramientas

Tool Pocket



MODELO MODEL	Bolsillo herramientas doble Double tool pouch
CÓDIGO CODE	090608
MATERIAL MATERIAL	Nylon Nylon
EMBALAJE PACKING	6 unid. 6 pcs.
MEDIDAS EMBALAJE PACKING SIZES	290x250x180 mm



MODELO MODEL	Bolsillo herramientas simple Simple tool pouch
CÓDIGO CODE	089602
MATERIAL MATERIAL	Nylon Nylon
EMBALAJE PACKING	10 unid. 10 pcs.
MEDIDAS EMBALAJE PACKING SIZES	230x230x250 mm



MODELO MODEL	Bolsillo herramientas simple-profesional Professional simple tool pouch
CÓDIGO CODE	091605
MATERIAL MATERIAL	Nylon Nylon
EMBALAJE PACKING	10 unid. 10 pcs.
MEDIDAS EMBALAJE PACKING SIZES	530x280x240 mm



MODELO MODEL	Bolsillo herramientas doble-profesional Professional double tool pouch
CÓDIGO CODE	092602
MATERIAL MATERIAL	Nylon Nylon
EMBALAJE PACKING	6 unid. 6 pcs.
MEDIDAS EMBALAJE PACKING SIZES	530x280x280 mm



PRODUCTOS DE ORGANIZACIÓN

ARRANGEMENT PRODUCTS



2 PRODUCTOS DE ORDENACIÓN

ARRANGEMENT PRODUCTS

- | | | | | |
|---|---|---|--|---|
| 40 |  |  | 42 |  |
| GAVETAS APILABLES
STACKABLE DRAWERS | | | GAVETA PLEGABLE APILABLE
STACKABLE FOLDING DRAWER | |
| 44 |  |  | 45 |  |
| EURO-CAJAS PARA
ALMACÉN Y TRANSPORTE
EURO BOX | | | EURO-CAJAS CON TAPA
PARA ALMACÉN Y TRANSPORTE
EURO BOX WITH COVER | |
| 46 |  |  | 46 |  |
| CAJONES ESTANTERÍAS
DRAWERS FOR SHELVES | | | SEPARADORES
DIVIDERS | |
| 47 |  |  | 48 |  |
| KIT ESTANTERÍA METÁLICA
METAL SHELVES KIT | | | KIT ESTANTERÍA METÁLICA
CON CAJONES
METAL SHELVES KIT WITH DRAWERS | |
| 49 |  |  | 50 |  |
| KIT ESTANTERÍA PLÁSTICO
PLASTIC SHELVES KIT | | | KIT ESTANTERÍA PLÁSTICO
CON GAVETAS
PLASTIC SHELVES KIT WITH DRAWERS | |
| 51 |  |  | 52 |  |
| CONTENEDORES BASCULANTES
CABINET WITH TILTABLE DRAWERS | | | MÓDULOS METÁLICOS
METAL STACKABLE MODULES | |
| 53 |  |  | 54 |  |
| CONTENEDORES CAJONES
CABINETS WITH DRAWERS | | | CLASIFICADORES APILABLES
STACKABLE CLASSIFIERS SHELF UNIT | |
| 55 |  |  | 55 |  |
| MÓDULOS APILABLES
STACKABLE MODULES | | | MÓDULOS BANDEJAS
TRAY MODULES | |
| 56 |  |  | 57 |  |
| MULTIBOX
MULTIBOX | | | MULTIBOX2
MULTIBOX2 | |
| 58 |  |  | 59 |  |
| BIDONES CON CÁNULA (VERTEDERO)
JERRY CANS WITH SPOUT (FOR POURING) | | | BIDONES CON TAPÓN/GRIFO
JERRY CANS WITH CAP/TAP | |

Gavettas Apilables

Stackable Drawers

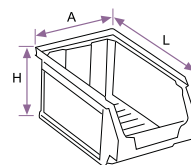
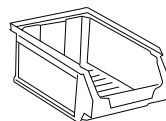
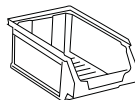
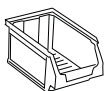

MODELO MODEL	51	52	53	54	55
CÓDIGO CODE	■ 251023 ■ 251108 □ 251344	■ 252020 ■ 252105 □ 252341	■ 253027 ■ 253102 □ 253348	■ 254024 ■ 254109 □ 254345	■ 255021 ■ 255106 □ 255342
MEDIDAS SIZES	L A H 170x100x80 mm	L A H 236x160x130 mm	L A H 336x160x130 mm	L A H 336x216x155 mm	L A H 336x216x200 mm
MATERIAL MATERIAL	PP	PP	PP	PP	PP
CAPACIDAD (Litros) Capacity (Liters)	0,8	3,2	4,8	7,7	10,1
EMBALAJE PACKING	24 unid.	15 unid.	10 unid.	12 unid.	10 unid.
MEDIDAS EMBALAJE PACKING SIZES	336x214x345 mm	820x240x255 mm	840x350x194 mm	440x378x610 mm	1120x350x304 mm

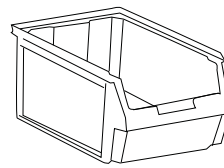
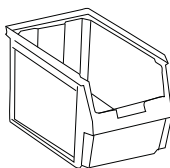
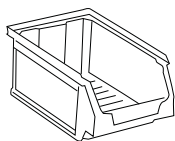
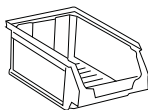

MODELO MODEL	56	58	59	60
CÓDIGO CODE	■ 256028 ■ 256103 □ 256349	■ 258022 ■ 258107 □ 258343	■ 259029 ■ 259104 □ 259340	■ 260025 ■ 260100 □ 260346
MEDIDAS SIZES	L A H 420x270x175 mm	L A H 500x303x200 mm	L A H 500x303x300 mm	L A H 600x400x300 mm
MATERIAL MATERIAL	PP	PP	PP	PP
CAPACIDAD (Litros) Capacity (Liters)	13,9	22,2	34	51,3
EMBALAJE PACKING	8 unid.	12 unid.	6 unid.	6 unid.
MEDIDAS EMBALAJE PACKING SIZES	580x426x530 mm	954x512x590 mm	954x512x485 mm	804x598x600 mm

R.S.I
N° 3904321/V



Gavetas Apilables

Stackable Drawers



APTO PARA USO ALIMENTARIO
Registro sanitario / Health registration
nº 3904321/V



MODELO MODEL	Kit Colgar G-04
CÓDIGO CODE	204906
MEDIDAS SIZES	L A H 170x487x77 mm
CONTIENE CONTAINED	3 Gavetas / 1 Colgador 3 Drawers / 1 Hanger
MATERIAL	Gaveta PP / Colgador PS Drawers PP / Hanger PS
EMBALAJE PACKING	10 unid.
MEDIDAS EMBALAJE PACKING SIZES	528x342x395 mm



MODELO MODEL	Kit Colgar G-09
CÓDIGO CODE	209901
MEDIDAS SIZES	L A H 170x520x50 mm
CONTIENE CONTAINED	5 Gavetas / 1 Colgador 5 Drawers / 1 Hanger
MATERIAL	Gaveta PP / Colgador PS Drawers PP / Hanger PS
EMBALAJE PACKING	10 unid.
MEDIDAS EMBALAJE PACKING SIZES	525x350x260 mm



MODELO MODEL	Kit Colgar G-50
CÓDIGO CODE	250903
MEDIDAS SIZES	L A H 91x520x53 mm
CONTIENE CONTAINED	5 Gavetas / 1 Colgador 5 Drawers / 1 Hanger
MATERIAL	Gaveta PP / Colgador PS Drawers PP / Hanger PS
EMBALAJE PACKING	10 unid.
MEDIDAS EMBALAJE PACKING SIZES	528x190x280 mm



MODELO MODEL	Kit Colgar G-51
CÓDIGO CODE	251900
MEDIDAS SIZES	L A H 170x520x80 mm
CONTIENE CONTAINED	5 Gavetas / 1 Colgador 5 Drawers / 1 Hanger
MATERIAL	Gaveta PP / Colgador PS Drawers PP / Hanger PS
EMBALAJE PACKING	10 unid.
MEDIDAS EMBALAJE PACKING SIZES	528x340x398 mm

Gavetta Plegable Apilable

Stackable Folding Drawer



Gaveta Plegable Apilable

Stackable Folding Drawer



MODELO MODEL	52P
CÓDIGO CODE	■ 202025 □ 202346
MEDIDAS SIZES	L A H 236x160x130 mm
MATERIAL	PP
CONTIENE CONTAINED	1 Kit = 5 Gavetas flejadas 1 Kit = 5 Strapped bin boxes
EMBALAJE PACKING	8 Kits = 40 unid.
MEDIDAS EMBALAJE PACKING SIZES	420x234x285 mm



Gaveta Ref. 52 y Ref. 52P
Son apilables y compatibles
Son apilables y compatibles



MODELO MODEL	53P
CÓDIGO CODE	■ 203022 □ 203343
MEDIDAS SIZES	L A H 336x160x130 mm
MATERIAL	PP
CONTIENE CONTAINED	1 Kit = 5 Gavetas flejadas
EMBALAJE PACKING	8 Kits = 40 unid.
MEDIDAS EMBALAJE PACKING SIZES	420x345x332 mm

Gaveta Ref. 53 y Ref. 53P
Son apilables y compatibles
Son apilables y compatibles

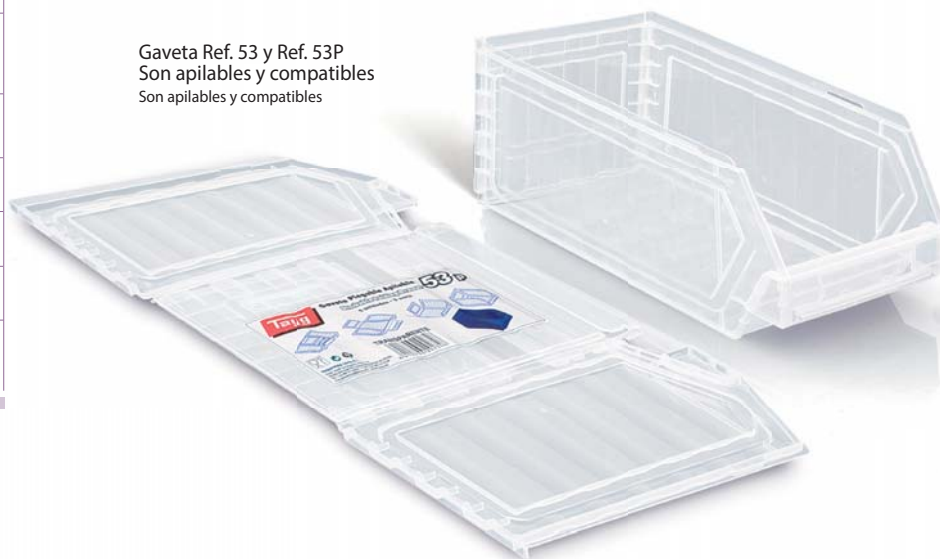

Euro-Cajas para Almacén y Transporte

Euro Box

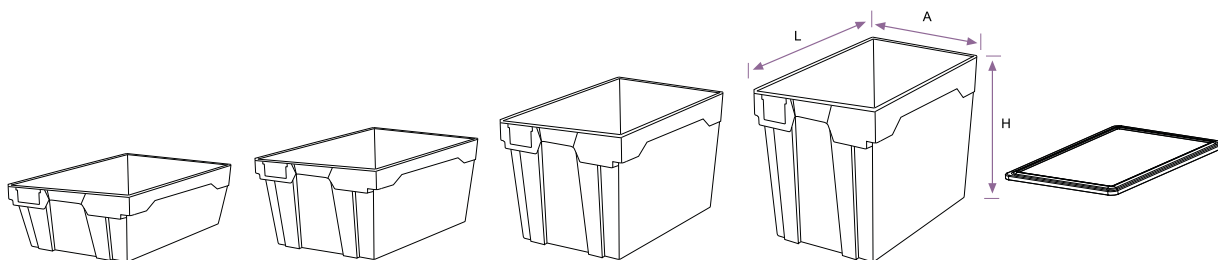

MODELO MODEL	6415	6420	6430	6440	6400
CÓDIGO CODE	■ 261008 ☒ 261299	■ 262005 ☒ 262296	■ 263002 ☒ 263293	■ 264009 ☒ 264290	■ 299001 ☒ 299292
MEDIDAS SIZES	L A H 600x400x150 mm	L A H 600x400x200 mm	L A H 600x400x300 mm	L A H 600x400x400 mm	L A H 600x405x29 mm
CAPACIDAD (Litros) Capacity (Liters)	22 L.	34 L.	51 L.	69 L.	-
PESO (KG.) WEIGHT (KG.)	1,23 Kg.	1,62 Kg.	2,16 Kg.	2,74 Kg.	0,65 Kg.
MATERIAL	PP	PP	PP	PP	PP
EMBALAJE PACKING	Retráctil 6 Palet 92	Retráctil 6 Palet 64	Retráctil 6 Palet 48	Retráctil 6 Palet 32	Retráctil 6
MEDIDAS EMBALAJE PACKING SIZES	Retráctil 600x400x360 mm Palet 1200x800x1224 mm	Retráctil 600x400x495 mm Palet 1200x800x1240 mm	Retráctil 600x400x645 mm Palet 1200x800x1215 mm	Retráctil 600x400x875 mm Palet 1200x800x1210 mm	Retráctil 605x405x120 mm



Euro-Cajas con Tapa para Almacén y Transporte

Euro Box With Cover

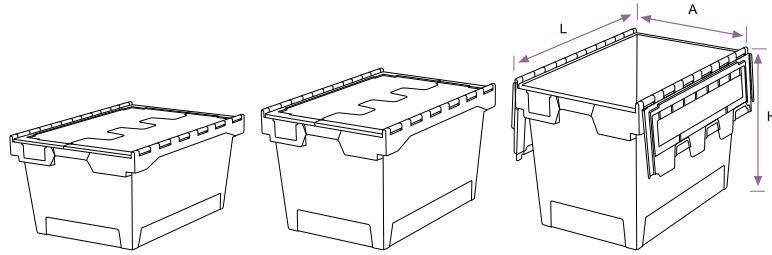

MODELO MODEL	6424-T	6434-T	6444-T
CÓDIGO CODE	■ 265006	■ 266003	■ 267000
MEDIDAS SIZES	L A H 600x400x240 mm	L A H 600x400x340 mm	L A H 600x400x440 mm
CAPACIDAD (Litros) Capacity (Liters)	39 L.	58 L.	75 L.
PESO (KG.) WEIGHT (KG.)	2,5 kg	3 kg	3,7 kg
MATERIAL MATERIAL	PP	PP	PP
EMBALAJE PACKING	Retráctil 6 Palet 56	Retráctil 6 Palet 48	Retráctil 6 Palet 32
MEDIDAS EMBALAJE PACKING SIZES	Retráctil 600x480x585 mm Palet 1200x960x1285 mm	Retráctil 600x480x690 mm Palet 1200x960x1250 mm	Retráctil 600x480x870 mm Palet 1200x960x1200 mm

PRODUCTOS DE ORDENACIÓN



 **APTO PARA USO ALIMENTARIO**
Registro sanitario / Health registration
n° 3904321/V

Cajones Estanterías

Drawers for Shelves

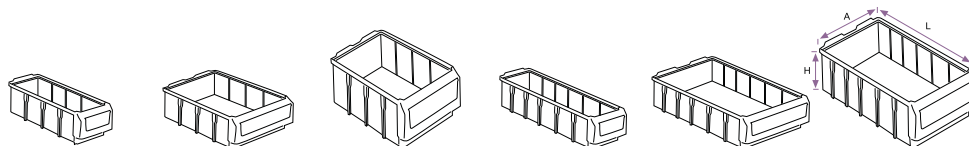

MODELO MODEL	301	302	303	401	402	403
CÓDIGO CODE	■ 355004	■ 356001	■ 357008	■ 360008	■ 361005	■ 362002
MEDIDAS SIZES	L A H 291x116x90 mm	L A H 291x232x90 mm	L A H 291x232x140 mm	L A H 391x116x90 mm	L A H 391x232x90 mm	L A H 391x232x140 mm
CAPACIDAD (Litros) Capacity (Liters)	2 L.	4,4 L.	7 L.	2,7 L.	6,1 L.	9,7 L.
MATERIAL MATERIAL	Cajones PP	Cajones PP	Cajones PP	Cajones PP	Cajones PP	Cajones PP
EMBALAJE PACKING	20 unid.	10 unid.	8 unid.	20 unid.	10 unid.	8 unid.
MEDIDAS EMBALAJE PACKING SIZES	470x298x434 mm	470x298x434 mm	470x298x558 mm	470x398x434 mm	470x398x434 mm	470x398x558 mm



Separadores

Dividers

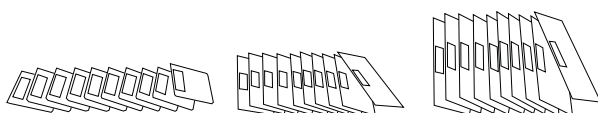

MODELO MODEL	01	02	03
CÓDIGO CODE	■ 390005	■ 391002	■ 392009
MEDIDAS SIZES	103x79 mm	219x79 mm	219x129 mm
MATERIAL MATERIAL	PP	PP	PP
EMBALAJE PACKING	20 unid.	10 unid.	10 unid.

Kit Estantería Metálica

Metal Shelves Kit

MODELO MODEL	300	400
CÓDIGO CODE	398001	399008
MEDIDAS SIZES	L A H 1030x337x2100 mm	L A H 1030x437x2100 mm
CONTIENE CONTAINED	4 Puntales 16 Bandejas 300 Acc. 16 Bandejas 300	4 Puntales 16 Bandejas 400 Acc. 16 Bandejas 400



MODELO MODEL	Kit estantería 301
CÓDIGO CODE	398308
CONTIENE CONTAINED	1 Estantería 300 (16 Bandejas) 120 Cajones 301 18 20-Separadores 01

MODELO MODEL	Kit estantería 401
CÓDIGO CODE	399305
CONTIENE CONTAINED	1 Estantería 400 (16 Bandejas) 120 Cajones 401 30 20-Separadores 01

MODELO MODEL	Kit estantería 302
CÓDIGO CODE	398315
CONTIENE CONTAINED	1 estantería 300 (16 Bandejas) 60 Cajones 302 18 10-Separadores 02

MODELO MODEL	Kit estantería 402
CÓDIGO CODE	399312
CONTIENE CONTAINED	1 estantería 400 (16 Bandejas) 60 Cajones 402 30 10-Separadores 02



Kit Estantería Metálica con Cajones

Metal Shelves Kit with Drawers



MODELO MODEL	Kit estantería 303	Kit estantería 403
CÓDIGO CODE	398322	399329
CONTIENE CONTAINED	1 estantería 300 (12 Bandejas) 48 Cajones 303 13 10-Separadores 03	1 estantería 400 (12 Bandejas) 48 Cajones 403 15 10-Separadores 03

MODELO MODEL	Kit estantería 310	Kit estantería 410
CÓDIGO CODE	398339	399336
CONTIENE CONTAINED	1 estantería 300 (15 Bandejas) 40 Cajones 301 20 Cajones 302 16 Cajones 303 6-20 Separadores 01 6-10 Separadores 02 4-10 Separadores 03	1 estantería 400 (15 Bandejas) 40 Cajones 401 20 Cajones 402 16 Cajones 403 10-20 Separadores 01 10-10 Separadores 02 8-10 Separadores 03



Kit Estantería Plástico

Plastic Shelves Kit

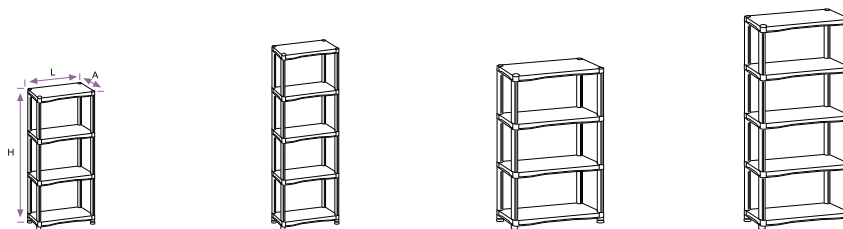

MODELO MODEL	744	745	944	945
CÓDIGO CODE	226007	225000	221002	220005
MEDIDAS SIZES	L A H 700x400x1366 mm	L A H 700x400x1800 mm	L A H 900x400x1366 mm	L A H 900x400x1800 mm
CONTIENE CONTAINED	4 Bandejas 12 Puntales 16 Casquillos reguladores 4 Tapones 4 Pies 2 Soportes estantería	5 Bandejas 16 Puntales 20 Casquillos reguladores 6 Tapones 6 Pies 3 Soportes estantería	4 Bandejas 12 Puntales 16 Casquillos reguladores 4 Tapones 4 Pies 2 Soportes estantería	5 Bandejas 16 Puntales 20 Casquillos reguladores 6 Tapones 6 Pies 3 Soportes estantería
MATERIAL MATERIAL	Resina PP	Resina PP	Resina PP	Resina PP
EMBALAJE PACKING	1 unid.	1 unid.	1 unid.	1 unid.
MEDIDAS EMBALAJE PACKING SIZES	700x400x200 mm	700x400x250 mm	900x400x200 mm	900x400x250 mm

*No se necesitan herramientas para su montaje.
Se monta en 10 minutos.
Fácil limpieza.
Pies elevados.
Balda regulable en altura.
Baldas reforzadas.
Resina de polipropileno.
Ecológica. 100% reciclable.
Doble soporte de fijación en pared.
Presentación en paquete retráctil fácilmente transportable.



Kit Estantería Plástico

Plastic Shelves Kit

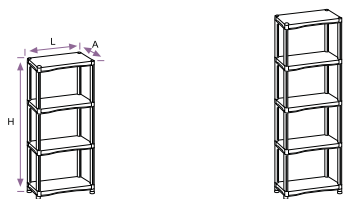

MODELO MODEL	634	635
CÓDIGO CODE	228001	227004
MEDIDAS SIZES	L A H 600x300x1370 mm	L A H 600x300x1800 mm
CONTIENE CONTAINED	4 Bandejas 12 Puntales 4 Tapones 4 Pies 2 Soportes estantería	5 Bandejas 16 Puntales 4 Tapones 4 Pies 2 Soportes estantería
MATERIAL MATERIAL	Resina PP	Resina PP
EMBALAJE PACKING	1 unid.	1 unid.
MEDIDAS EMBALAJE PACKING SIZES	600x300x170 mm	600x300x215 mm



Kit Estantería Plástico con Gavetas

Plastic Shelves Kit with Drawers



MODELO MODEL	56-A
CÓDIGO CODE	222023
COLOR COLOUR	Gaveta Azul Estantería Negro
MEDIDAS SIZES	900x400x1800 mm
MATERIAL MATERIAL	24 Gavetas-56 (3 cajas de 8 unid.) 8 Bandejas 16 Puntales 32 casquillos regulables 4 Tapones 4 Pies 2 Soportes estantería
MATERIAL MATERIAL	Estantería Resina PP Gavetas PP



MODELO MODEL	56-R
CÓDIGO CODE	222108
COLOR COLOUR	Gaveta Rojo Estantería Negro
MEDIDAS SIZES	900x400x1800 mm
MATERIAL MATERIAL	24 Gavetas-56 (3 cajas de 8 unid.) 8 Bandejas 16 Puntales 32 casquillos regulables 4 Tapones 4 Pies 2 Soportes estantería
MATERIAL MATERIAL	Estantería Resina PP Gavetas PP

Contenedores Basculantes

Cabinet with Tiltable Drawers



CÓDIGO CODE	339066	336065	335068
CAJONES DRAWERS	9	6	5
MEDIDAS SIZES	L A H 600x63x81	L A H 600x92x114	L A H 600x133x165
COLOR COLOUR	Gris Grey	Gris Grey	Gris Grey
MATERIAL MATERIAL	PS	PS	PS
EMBALAJE PACKING	12 unid.	12 unid.	6 unid.
MEDIDAS EMBALAJE PACKING SIZES	605x270x250	605x405x355	605x440x350

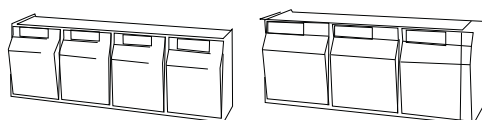

CÓDIGO CODE	334061	333064
CAJONES DRAWERS	4	3
MEDIDAS SIZES	600x168x206	600x196x241
COLOR COLOUR	Gris Grey	Gris Grey
MATERIAL MATERIAL	PS	PS
EMBALAJE PACKING	6 unid.	4 unid.
MEDIDAS EMBALAJE PACKING SIZES	605x350x635	605x410x490

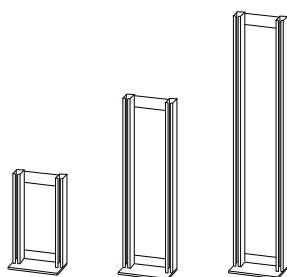

SOPORTE CÓDIGO CODE	340000	341007	342004
MEDIDAS SIZES	60 cm	121 cm	177 cm

VARILLA
CIERRE



CÓDIGO CODE	343001 VARILLA CIERRE
CÓDIGO CODE	344008 (10 tornillos y arandelas)

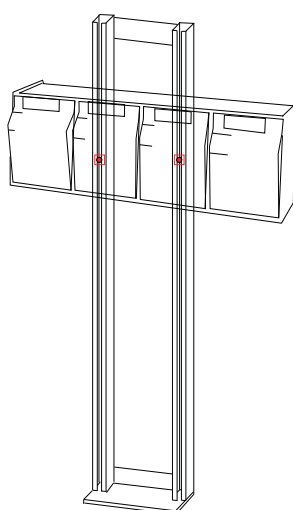

Módulos Metálicos

Metal Stackable Modules

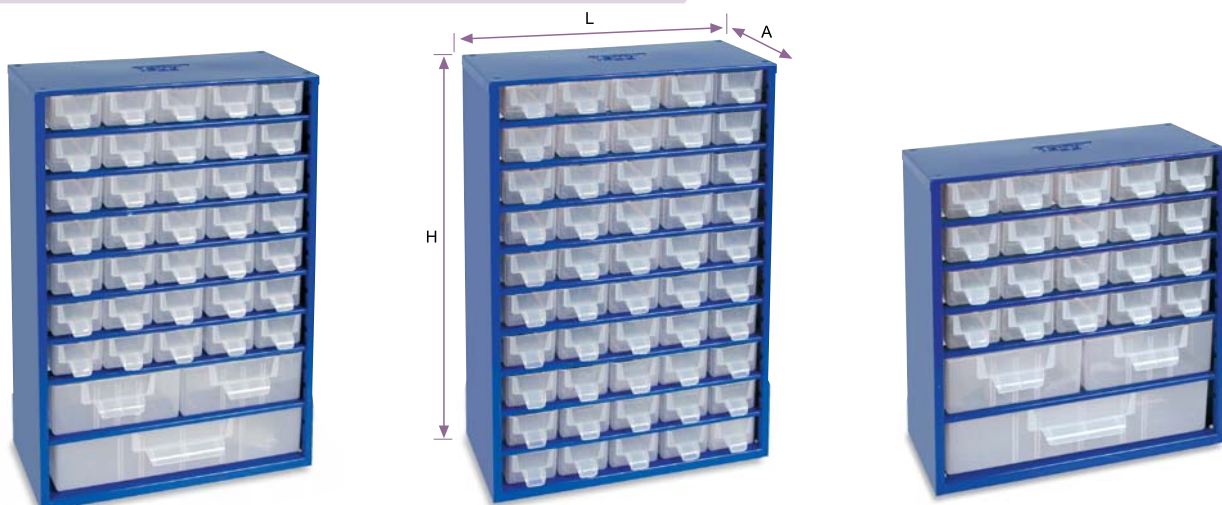

MODELO MODEL	35/2/1
CÓDIGO CODE	313004
MEDIDAS SIZES	LxAxH 305x145x462 mm
EMBALAJE PACKING	4 unid.
MATERIAL MATERIAL	Armazón-Chapa de acero-Pintura epoxi <i>Frame-Steel sheet</i> Cajones pp <i>Drawers</i>
MEDIDAS EMBALAJE PACKING SIZE	650x495x345 mm

MODELO MODEL	50/0/0
CÓDIGO CODE	314001
MEDIDAS SIZES	LxAxH 305x145x462 mm
EMBALAJE PACKING	4 unid.
MATERIAL MATERIAL	Armazón-Chapa de acero-Pintura epoxi <i>Frame-Steel sheet</i> Cajones pp <i>Drawers</i>
MEDIDAS EMBALAJE PACKING SIZE	650x495x345 mm

MODELO MODEL	20/2/1
CÓDIGO CODE	315008
MEDIDAS SIZES	LxAxH 305x145x328 mm
EMBALAJE PACKING	4 unid.
MATERIAL MATERIAL	Armazón-Chapa de acero-Pintura epoxi <i>Frame-Steel sheet</i> Cajones pp <i>Drawers</i>
MEDIDAS EMBALAJE PACKING SIZE	665x335x355 mm



MODELO MODEL	35/0/0
CÓDIGO CODE	316005
MEDIDAS SIZES	305x145x328 mm
EMBALAJE PACKING	4 unid.
MATERIAL MATERIAL	Armazón-Chapa de acero-Pintura epoxi <i>Frame-Steel sheet</i> Cajones pp <i>Drawers</i>
MEDIDAS EMBALAJE PACKING SIZE	665x335x355 mm

MODELO MODEL	10/2/1
CÓDIGO CODE	317002
MEDIDAS SIZES	305x145x237 mm
EMBALAJE PACKING	4 unid.
MATERIAL MATERIAL	Armazón-Chapa de acero-Pintura epoxi <i>Frame-Steel sheet</i> Cajones pp <i>Drawers</i>
MEDIDAS EMBALAJE PACKING SIZE	650x335x260 mm

MODELO MODEL	25/0/0
CÓDIGO CODE	318009
MEDIDAS SIZES	305x145x237 mm
EMBALAJE PACKING	4 unid.
MATERIAL MATERIAL	Armazón-Chapa de acero-Pintura epoxi <i>Frame-Steel sheet</i> Cajones pp <i>Drawers</i>
MEDIDAS EMBALAJE PACKING SIZE	650x335x260 mm

Contenedores Cajones

Cabinet with Drawers

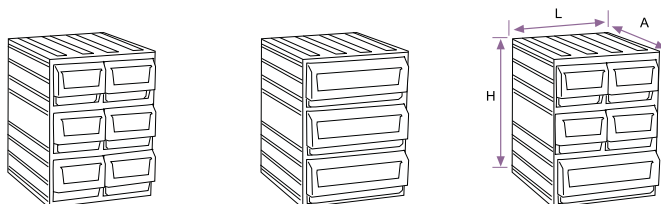

MODELO MODELO	300/6	300/3	300/5
CÓDIGO CODE	350009	351006	352003
MEDIDAS EXTERIORES OUTER SIZES	LxAxH 245x291x321 mm	LxAxH 245x291x321 mm	LxAxH 245x291x321 mm
CAJONES DRAWERS MEDIDAS SIZES	6 291x116x95 mm	3 291x232x95 mm	4 291x116x95 mm 1 291x232x95 mm
SEPARADOR CAJONES DRAWERS SEPARATOR	18 sep-01	9 sep-02	12 sep-01 3 sep-02
MATERIAL MATERIAL	Armazón PS Frame Cajones PP Drawers	Armazón PS Frame Cajones PP Drawers	Armazón PS Frame Cajones PP Drawers
COLOR COLOUR	Armazón Negro Frame Black Cajones Azul Drawers Blue	Armazón Negro Frame Black Cajones Azul Drawers Blue	Armazón Negro Frame Black Cajones Azul Drawers Blue
EMBALAJE PACKING	2 unid.	2 unid.	2 unid.
MEDIDAS EMBALAJE PACKING SIZES	496x298x330	496x298x330	496x298x330



Ensamble sobre guías
Assembling on guides

Clasificadores Apilables

Stackable Classifiers Shelf Unit

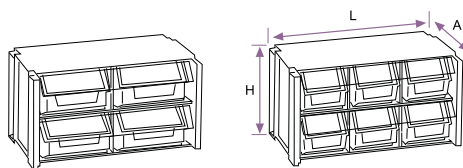

CÓDIGO CODE	304002	306006
MEDIDAS EXTERIORES OUTER SIZES	LxAxH 360x170x190 mm	LxAxH 360x170x190 mm
GAVETAS DRAWERS	4	6
MEDIDAS GAVETAS DRAWER SIZES	160x170x80 mm	100x170x80 mm
MATERIAL MATERIAL	Armazón PS Frame Gavetas PP Drawers	Armazón PS Frame Gavetas PP Drawers
COLOR COLOUR	Armazón Negro Frame Black Gavetas Rojo Drawers Red	Armazón Negro Frame Black Gavetas Rojo Drawers Red
EMBALAJE PACKING	4 unid.	4 unid.
MEDIDAS EMBALAJE PACKING SIZES	365x356x380	365x356x380

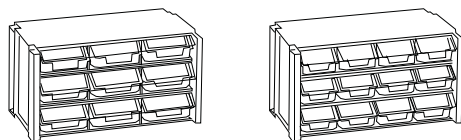

CÓDIGO CODE	309007	312007
MEDIDAS EXTERIORES OUTER SIZES	LxAxH 360x170x190 mm	LxAxH 360x170x190 mm
GAVETAS DRAWERS	9	12
MEDIDAS GAVETAS DRAWER SIZES	100x170x50 mm	80x170x50 mm
MATERIAL MATERIAL	Armazón PS Frame Gavetas PP Drawers	Armazón PS Frame Gavetas PP Drawers
COLOR COLOUR	Armazón Negro Frame Black Gavetas Rojo Drawers Rojo	Armazón Negro Frame Black Gavetas Rojo Drawers Rojo
EMBALAJE PACKING	4 unid.	4 unid.
MEDIDAS EMBALAJE PACKING SIZES	365x356x380	365x356x380



Módulos Apilables

Stackable Modules

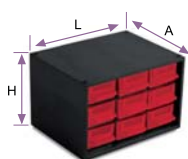

CÓDIGO CODE	345005	346002	347009	348006
MEDIDAS EXTERIORES OUTER SIZES	LxAxH 218x167x140 mm	LxAxH 218x167x140 mm	LxAxH 218x167x140 mm	LxAxH 218x167x140 mm
CAJONES TRAY MEDIDAS SIZES	9 150x62x37 mm	6 150x127x37 mm	3 150x127x37 mm 6 150x62x37 mm	12 150x62x37 mm
SEPARADOR CAJONES DRAWERS SEPARATOR	9 unid.	6 unid.	3 unid. 6 unid.	12 unid.
MATERIAL MATERIAL	PS	PS	PS	PS
COLOR COLOUR	Armazón Negro Frame Black Gavetas Rojas Drawers Red	Armazón Negro Frame Black Gavetas Rojas Drawers Red	Armazón Negro Frame Black Gavetas Rojas Drawers Red	Armazón Negro Frame Black Gavetas Rojas Drawers Red
EMBALAJE PACKING	6 unid.	6 unid.	6 unid.	6 unid.
MEDIDAS EMBALAJE PACKING SIZES	345x224x440 mm	345x290x440 mm	345x290x440 mm	345x290x440 mm

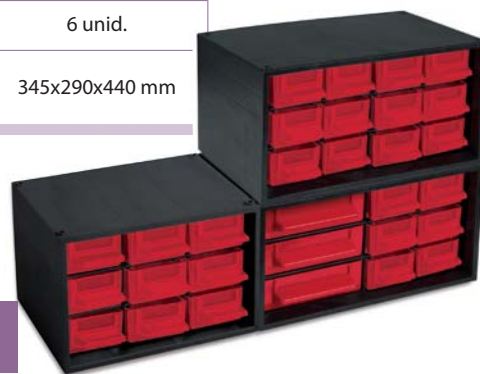

Módulos Bandejas

Tray Modules

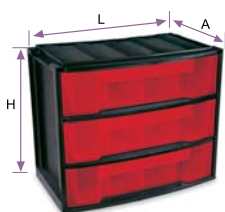

CÓDIGO CODE	321009	322006	323003
MEDIDAS EXTERIORES OUTER SIZES	LxAxH 290x167x255 mm	LxAxH 290x167x255 mm	LxAxH 290x167x255 mm
BANDEJA TRAY MEDIDAS SIZES	3 256x162x65 mm	1 256x162x65 mm 4 256x162x30 mm	6 256x162x30 mm
MATERIAL MATERIAL	Armazón PS Frame Bandeja PP Tray	Armazón PS Frame Bandeja PP Tray	Armazón PS Frame Bandeja PP Tray
COLOR COLOUR	Armazón Negro Frame Black Bandeja Rojo Tray Red	Armazón Negro Frame Black Bandeja Rojo Tray Red	Armazón Negro Frame Black Bandeja Rojo Tray Red
EMBALAJE PACKING	4 unid.	4 unid.	4 unid.
MEDIDAS EMBALAJE PACKING SIZES	345x304x490 mm	345x304x490 mm	345x304x490 mm



Multibox

Multibox

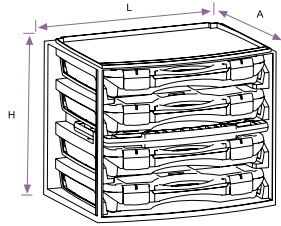

MODELO MODELO	Multibox nº1
CÓDIGO CODE	301001
MEDIDAS SIZES	LxAxH 335x250x275 mm
CONTIENE CONTAINED	Módulo + 4 estuches 22 + asa
MATERIAL MATERIAL	PP
EMBALAJE PACKING	2 unid.
MEDIDAS EMBALAJE PACKING SIZES	680x280x260 mm





**EN CONSTRUCCIÓN
PRODUCTO DISPONIBLE DURANTE 2014**



**PRODUCT UNDER CONSTRUCTION
AVAILABLE DURING 2014**

Bidones con Cánula (Vertedero)

Jerry Cans With Spout (For Pouring)

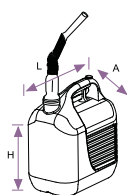

CÓDIGO CODE	601354	602351	603358	604355
CAPACIDAD CAPACITY	5 l.	10 l.	20 l.	30 l.
MEDIDAS SIZES	LxAxH 230x145x257 mm	LxAxH 265x200x307 mm	LxAxH 345x234x377 mm	LxAxH 400x237x464 mm
MATERIAL MATERIAL	HDPE	HDPE	HDPE	HDPE
EMBALAJE PACKING	6 unid.	6 unid.	5 unid.	5 unid.
MEDIDAS EMBALAJE PACKING SIZES	780x290x230 mm	780x396x307 mm	1175x377x345 mm	1180x400x464 mm



Homologados para transporte de mercancías peligrosas clases 3, 6.1, 8 y 9
Norma ADR (Transporte Internacional Carretera)
Norma RID (Transporte Internacional por Ferrocarril)
Norma IMDG (Transporte Internacional Marítimo)
Norma IATA/OACI (Transporte Internacional Aéreo)

PRESIÓN HIDRÁULICA 200 KPa

Toma de aire para garantizar un vertido uniforme.

CLASE CLASS	GRUPO GROUP	DESCRIPCIÓN DESCRIPTION	EJEMPLOS EXAMPLES
3	Y	INFLAMABLES	Gasolina, gasoil, otros hidrocarburos, acetona, alcoholes (metanol, etanol...) aldehidos, benceno, tolueno, xileno, éteres, ésteres, aceites, disolventes, lacas, pinturas, esmaltes, barniz...
6.1	Y	TÓXICOS	Anilinas, cloroformo, desinfectantes, plaguicidas, bencidina y compuestos de: mercurio, plomo, bario, berilio, arsénico, antimonio talio, cianuro...
8	Y	CORROSIVOS	Ácidos (sulfúrico, nítrico, fosfórico, acético, fórmico...) sulfamán Hidróxidos de: potasio, sosa, litio... Lejías, amoníaco, electrolitos, soluciones cáusticas...
9	Y	VARIOS	Amiantos, difenilos policlorados, material líquido peligroso para el medio ambiente...



Tapones y Cánulas

Caps and Spouts



CÓDIGO CODE	607004	607001	616006
CAPACIDAD CAPACITY	5 l. y 10 l.	20 l. y 30 l.	5 l., 10 l., 20 l. y 30 l.



CÓDIGO CODE	605000	606007
CAPACIDAD CAPACITY	5 l. y 10 l.	20 l. y 30 l.

Bidones con Tapón / Grifo

Jerry Cans With Cap / Tap

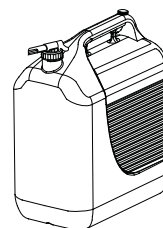
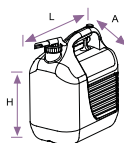

CÓDIGO CODE	601361	602368	603365	604362
CAPACIDAD CAPACITY	5 l.	10 l.	20 l.	30 l.
MEDIDAS SIZES	LxAxH 230x145x257 mm	LxAxH 265x200x307 mm	LxAxH 345x234x377 mm	LxAxH 400x237x464 mm
MATERIAL MATERIAL	HDPE	HDPE	HDPE	HDPE
EMBALAJE PACKING	6 unid.	6 unid.	5 unid.	5 unid.
MEDIDAS EMBALAJE PACKING SIZES	780x290x230 mm	780x396x307 mm	1175x377x345 mm	1180x400x464 mm

Toma de aire para garantizar un vertido uniforme.



 **APTO PARA USO ALIMENTARIO**
Registro sanitario / Health registration
nº 3900923/V

Tapón Grifo

Cap Tap

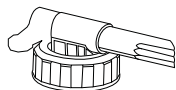
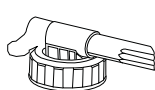

CÓDIGO CODE	609008	610004	617003
CAPACIDAD CAPACITY	5 l. y 10 l.	20 l. y 30 l.	5 l., 10 l., 20 l. y 30 l.





TAYG

ECO
TAYG
ECO TAYG



3 ECO TAYG

ECO TAYG

62
CONTENEDOR RESIDUOS
100 L
WASTE CONTAINER 100 L



63
CONTENEDOR RESIDUOS
CON PEDAL 100 L
WASTE CONTAINER 100 L WITH PEDAL

64
CONTENEDOR RESIDUOS
120 L
WASTE CONTAINER 120 L



65
CONTENEDOR RESIDUOS
CON PEDAL 120 L
WASTE CONTAINER 120 L WITH PEDAL

66
CONTENEDOR RESIDUOS
WASTE CONTAINER



67
TAPAS CONTENEDOR RESIDUOS
CONTAINER COVER

68
CONTENEDOR RESIDUOS
95 L
WASTE CONTAINER 95 L



69
CONTENEDOR RESIDUOS
75 L
WASTE CONTAINER 75 L

70
CONTENEDOR RESIDUOS
50 L
WASTE CONTAINER 50 L



71
TAPAS CONTENEDOR RESIDUOS
95-75-50 L
CONTAINER COVER

72
CONTENEDOR USO
ALIMENTARIO
FOOD GRADE CONTAINER



73
CONTENEDOR MULTIUSOS 30 L
CONTAINER MULTIPURPOSE 30 L

Contenedor Residuos 100 L

Waste Container 100 L



MODELO MODEL	100 AZ	100 VE	100 GR	100 AM	100 RO
CÓDIGO CODE	420023	420030	420009	420016	420108
MEDIDAS SIZES	600x568x770 mm	600x568x770 mm	600x568x770 mm	600x568x770 mm	600x568x770 mm
CONTIENE CONTAINED	Con ruedas	Con ruedas	Con ruedas	Con ruedas	Con ruedas
CAPACIDAD CAPACITY	100 l.	100 l.	100 l.	100 l.	100 l.
COLOR COLOUR	Base-Negra Tapa-Azul Rueda-Negra	Base-Negra Tapa-Verde Rueda-Negra	Base-Negra Tapa-Gris Rueda-Negra	Base-Negra Tapa-Amarilla Rueda-Negra	Base-Negra Tapa-Roja Rueda-Negra
MATERIAL MATERIAL	PP	PP	PP	PP	PP
EMBALAJE PACKING	3 unid.	3 unid.	3 unid.	3 unid.	3 unid.
MEDIDAS EMBALAJE PACKING SIZES	600x568x1070 mm	600x568x1070 mm	600x568x1070 mm	600x568x1070 mm	600x568x1070 mm



Contenedor Residuos 100 L con Pedal

Waste Container 100 L with Pedal



MODELO MODEL	100 AZ-P	100 VE-P	100 GR-P	100 AM-P	100 RO-P
CÓDIGO CODE	421020	421037	421006	421013	421105
MEDIDAS SIZES	600x568x770 mm	600x568x770 mm	600x568x770 mm	600x568x770 mm	600x568x770 mm
CONTIENE CONTAINED	Con ruedas	Con ruedas	Con ruedas	Con ruedas	Con ruedas
CAPACIDAD CAPACITY	100 l.	100 l.	100 l.	100 l.	100 l.
COLOR COLOUR	Base-Negra Tapa-Azul Rueda-Negra Pedal-Gris	Base-Negra Tapa-Verde Rueda-Negra Pedal-Gris	Base-Negra Tapa-Gris Rueda-Negra Pedal-Gris	Base-Negra Tapa-Amarilla Rueda-Negra Pedal-Gris	Base-Negra Tapa-Roja Rueda-Negra Pedal-Gris
MATERIAL MATERIAL	PP	PP	PP	PP	PP
EMBALAJE PACKING	3 unid.	3 unid.	3 unid.	3 unid.	3 unid.
MEDIDAS EMBALAJE PACKING SIZES	600x568x1070 mm	600x568x1070 mm	600x568x1070 mm	600x568x1070 mm	600x568x1070 mm



Contenedor Residuos 120 L

Waste Container 120 L



MODELO MODEL	120 AZ	120 VE	120 GR	120 AM	120 RO
CÓDIGO CODE	422027	422034	422003	422010	422102
MEDIDAS SIZES	600x568x886 mm	600x568x886 mm	600x568x886 mm	600x568x886 mm	600x568x886 mm
CONTIENE CONTAINED	Con ruedas	Con ruedas	Con ruedas	Con ruedas	Con ruedas
CAPACIDAD CAPACITY	120 l.	120 l.	120 l.	120 l.	120 l.
COLOR COLOUR	Base-Negra Tapa-Azul Rueda-Negra	Base-Negra Tapa-Verde Rueda-Negra	Base-Negra Tapa-Gris Rueda-Negra	Base-Negra Tapa-Amarilla Rueda-Negra	Base-Negra Tapa-Roja Rueda-Negra
MATERIAL MATERIAL	PP	PP	PP	PP	PP
EMBALAJE PACKING	3 unid.	3 unid.	3 unid.	3 unid.	3 unid.
MEDIDAS EMBALAJE PACKING SIZES	600x568x1168 mm	600x568x1168 mm	600x568x1168 mm	600x568x1168 mm	600x568x1168 mm



Contenedor residuos 120 L con Pedal

Waste Container 120 L with Pedal



MODELO MODEL	120 AZ-P	120 VE-P	120 GR-P	120 AM-P	120 RO-P
CÓDIGO CODE	423024	423031	423000	423017	423109
MEDIDAS SIZES	600x568x886 mm	600x568x886 mm	600x568x886 mm	600x568x886 mm	600x568x886 mm
CONTIENE CONTAINED	Con ruedas	Con ruedas	Con ruedas	Con ruedas	Con ruedas
CAPACIDAD CAPACITY	120 l.	120 l.	120 l.	120 l.	120 l.
COLOR COLOUR	Base-Negra Tapa-Azul Rueda-Negra Pedal-Gris	Base-Negra Tapa-Verde Rueda-Negra Pedal-Gris	Base-Negra Tapa-Gris Rueda-Negra Pedal-Gris	Base-Negra Tapa-Amarilla Rueda-Negra Pedal-Gris	Base-Negra Tapa-Roja Rueda-Negra Pedal-Gris
MATERIAL MATERIAL	PP	PP	PP	PP	PP
EMBALAJE PACKING	3 unid.	3 unid.	3 unid.	3 unid.	3 unid.
MEDIDAS EMBALAJE PACKING SIZES	600x568x1168 mm	600x568x1168 mm	600x568x1168 mm	600x568x1168 mm	600x568x1168 mm



Contenedor Jardín 120 L

Garden Container 120 L

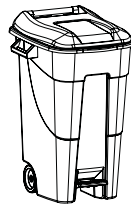
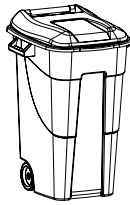

MODELO MODEL	120 J	120 J P
CÓDIGO CODE	424007	426001
MEDIDAS SIZES	600x568x886 mm	600x568x886 mm
CONTIENE CONTAINED	Con ruedas	Con ruedas Y PEDAL
CAPACIDAD CAPACITY	120 l.	120 l.
COLOR COLOUR	Base-Verde Tapa-Verde Rueda-Negra	Base-Verde Tapa-Verde Rueda-Negra PEDAL GRIS
MATERIAL MATERIAL	PP	PP
EMBALAJE PACKING	3 unid.	3 unid.
MEDIDAS EMBALAJE PACKING SIZES	600x568x986 mm	600x568x986 mm



Tapas Contenedor residuos 100 L-120 L

Waste Container Cover 100 L-120 L



MODELO MODEL	T 120 AZ	T 120 VE	T 120 GR	T 120 AM	T 120 RO
CÓDIGO CODE	425028	425035	425004	425011	425103
MEDIDAS SIZES	572x522x92 mm	572x522x92 mm	572x522x92 mm	572x522x92 mm	572x522x92 mm
COLOR COLOUR	Azul	Verde	Gris	Amarilla	Roja
MATERIAL MATERIAL	PP	PP	PP	PP	PP
EMBALAJE PACKING	4 unid.	4 unid.	4 unid.	4 unid.	4 unid.
MEDIDAS EMBALAJE PACKING SIZES	524x598x270 mm	524x598x270 mm	524x598x270 mm	524x598x270 mm	524x598x270 mm



VERDE (VIDRIO)

En el iglú verde depositamos envases y botellas de vidrio.



ROJO (DESECHOS PELIGROSOS)

Los contenedores rojos se utilizan para almacenar desechos peligrosos como baterías, pilas, insecticidas, aceites, aerosoles o productos tecnológicos.



GRIS (RESTO DE RESIDUOS)

En los contenedores de color gris se depositan los residuos que no se incluyen en el resto de contenedores, además de la materia biodegradable.



AZUL (PAPEL Y CARTÓN)

En el contenedor azul se depositan todo tipo de papeles y cartones: cajas, envases de alimentos, periódicos, revistas, papeles de envolver, folletos publicitarios, etc.



AMARILLO (PLÁSTICOS, LATAS Y TETABRICS)

En este contenedor se introducen todo tipo de envases y productos fabricados con plásticos como botellas, envases de alimentación o bolsas, además de las latas de conservas y de refrescos.

Contenedor Residuos 95 L

Waste Container 95 L



MODELO MODEL	95 AZ	95 VE	95 GR	95 AM	95 RO
CÓDIGO CODE	410024	410031	410000	410017	410109
MEDIDAS SIZES	600x402x676 mm	600x402x676 mm	600x402x676 mm	600x402x676 mm	600x402x676 mm
CONTIENE CONTAINED	Con cierres	Con cierres	Con cierres	Con cierres	Con cierres
CAPACIDAD CAPACITY	95 l.	95 l.	95 l.	95 l.	95 l.
COLOR COLOUR	Base-Negra Tapa-Azul	Base-Negra Tapa-Verde	Base-Negra Tapa-Gris	Base-Negra Tapa-Amarilla	Base-Negra Tapa-Roja
MATERIAL MATERIAL	PP	PP	PP	PP	PP
EMBALAJE PACKING	4 unid.	4 unid.	4 unid.	4 unid.	4 unid.
MEDIDAS EMBALAJE PACKING SIZES	600x402x947 mm	600x568x947 mm	600x568x947 mm	600x568x947 mm	600x568x947 mm



Contenedor Residuos 75 L

Waste Container 75 L



MODELO MODEL	75 AZ	75 VE	75 GR	75 AM	75 RO
CÓDIGO CODE	411021	411038	411007	411014	411106
MEDIDAS SIZES	600x402x505 mm	600x402x505 mm	600x402x505 mm	600x402x505 mm	600x402x505 mm
CONTIENE CONTAINED	Con cierres	Con cierres	Con cierres	Con cierres	Con cierres
CAPACIDAD CAPACITY	75 l.	75 l.	75 l.	75 l.	75 l.
COLOR COLOUR	Base-Negra Tapa-Azul	Base-Negra Tapa-Verde	Base-Negra Tapa-Gris	Base-Negra Tapa-Amarilla	Base-Negra Tapa-Roja
MATERIAL MATERIAL	PP	PP	PP	PP	PP
EMBALAJE PACKING	4 unid.	4 unid.	4 unid.	4 unid.	4 unid.
MEDIDAS EMBALAJE PACKING SIZES	600x402x775 mm	600x402x775 mm	600x402x775 mm	600x402x775 mm	600x402x775 mm



Contenedor Residuos 50 L.

Waste Container 50 L.



MODELO MODEL	50 AZ	50 VE	50 GR	50 AM	50 RO
CÓDIGO CODE	412028	412035	412004	412011	412103
MEDIDAS SIZES	399x399x468 mm	399x399x468 mm	399x399x468 mm	399x399x468 mm	399x399x468 mm
CONTIENE CONTAINED	Con cierres	Con cierres	Con cierres	Con cierres	Con cierres
CAPACIDAD CAPACITY	50 l.	50 l.	50 l.	50 l.	50 l.
COLOR COLOUR	Base-Negra Tapa-Azul	Base-Negra Tapa-Verde	Base-Negra Tapa-Gris	Base-Negra Tapa-Amarilla	Base-Negra Tapa-Roja
MATERIAL MATERIAL	PP	PP	PP	PP	PP
EMBALAJE PACKING	4 unid.	4 unid.	4 unid.	4 unid.	4 unid.
MEDIDAS EMBALAJE PACKING SIZES	399x399x662 mm	399x399x662 mm	399x399x662 mm	399x399x662 mm	399x399x662 mm



Tapa Contenedor Residuos 95 - 75 L

Container Cover 95 - 75 L



CÓDIGO CODE	413025	413032	413001	413018	413000
MEDIDAS SIZES	518x402x74 mm	518x402x74 mm	518x402x74 mm	518x402x74 mm	518x402x74 mm
CAPACIDAD CAPACITY	95-75 l.	95-75 l.	95-75 l.	95-75 l.	95-75 l.
COLOR COLOUR	Azul	Verde	Gris	Amarilla	Roja
MATERIAL MATERIAL	PP	PP	PP	PP	PP
EMBALAJE PACKING	4 unid.	4 unid.	4 unid.	4 unid.	4 unid.
MEDIDAS EMBALAJE PACKING SIZES	520x406x117 mm	520x406x117 mm	520x406x117 mm	520x406x117 mm	520x406x117 mm

Tapa Contenedor Residuos 50 L

Container Cover 50 L



CÓDIGO CODE	414022	414039	414008	414015	414107
MEDIDAS SIZES	399x399x54 mm	399x399x54 mm	399x399x54 mm	399x399x54 mm	399x399x54 mm
CAPACIDAD CAPACITY	50 l.	50 l.	50 l.	50 l.	50 l.
COLOR COLOUR	Azul	Verde	Gris	Amarilla	Roja
MATERIAL MATERIAL	PP	PP	PP	PP	PP
EMBALAJE PACKING	4 unid.	4 unid.	4 unid.	4 unid.	4 unid.
MEDIDAS EMBALAJE PACKING SIZES	403x403x91 mm	403x403x91 mm	403x403x91 mm	403x403x91 mm	403x403x91 mm

Contenedor Uso Alimentario 95 - 75 - 50 L.

Food Grade Container

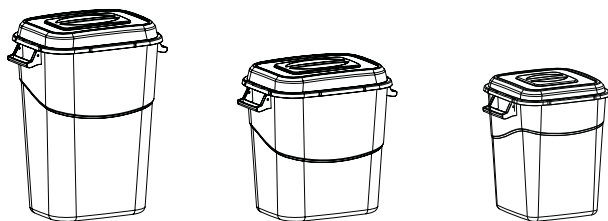

CÓDIGO CODE	410291	411298	412295
MEDIDAS SIZES	600x402x676 mm	600x402x505 mm	399x399x468 mm
CONTIENE CONTAINED	Con cierres	Con cierres	Con cierres
CAPACIDAD CAPACITY	95 l.	75 l.	50 l.
COLOR COLOUR	Base-Natural Tapa-Natural	Base-Natural Tapa-Natural	Base-Natural Tapa-Natural
MATERIAL MATERIAL	PP	PP	PP
EMBALAJE PACKING	3 unid.	3 unid.	3 unid.
MEDIDAS EMBALAJE PACKING SIZES	590x397x860 mm	590x397x860 mm	590x397x860 mm



CÓDIGO CODE	413292
MEDIDAS SIZES	518x402x74 mm
CAPACIDAD CAPACITY	95-75 l.
COLOR COLOUR	Natural
MATERIAL MATERIAL	PP
EMBALAJE PACKING	4 unid.
MEDIDAS EMBALAJE PACKING SIZES	520x406x117 mm



CÓDIGO CODE	414299
MEDIDAS SIZES	399x399x54 mm
CAPACIDAD CAPACITY	50 l.
COLOR COLOUR	Natural
MATERIAL MATERIAL	PP
EMBALAJE PACKING	5 unid.
MEDIDAS EMBALAJE PACKING SIZES	403x403x91 mm

 **APTO PARA USO ALIMENTARIO**
Registro sanitario / Health registration
nº 3904321/V



Contenedor Multiusos 30 L

Container Multipurpose 30 L



MODELO MODEL	30 AZ	30 VE	30 GR	30 AM	30 RO
CÓDIGO CODE	415029	415036	415005	415012	415104
MEDIDAS SIZES	392x399x330 mm	392x399x330 mm	392x399x330 mm	392x399x330 mm	392x399x330 mm
CONTIENE CONTAINED	Con cierres	Con cierres	Con cierres	Con cierres	Con cierres
CAPACIDAD CAPACITY	30 l.	30 l.	30 l.	30 l.	30 l.
COLOR COLOUR	Base-Negra Tapa-Azul	Base-Negra Tapa-Verde	Base-Negra Tapa-Gris	Base-Negra Tapa-Amarilla	Base-Negra Tapa-Roja
MATERIAL MATERIAL	PP	PP	PP	PP	PP
EMBALAJE PACKING	5 unid.	5 unid.	5 unid.	5 unid.	5 unid.
MEDIDAS EMBALAJE PACKING SIZES	418x404x472 mm	418x404x472 mm	418x404x472 mm	418x404x472 mm	418x404x472 mm





WIRA

ACCESORIOS
ELÉCTRICOS
ELECTRIC ACCESSORIES



4 ACCESORIOS ELÉCTRICOS

ELECTRIC ACCESSORIES

- | | | | |
|---|---|---|---|
| 76
PROLONGADORES
ELÉCTRICOS
EXTENSION CABLES |  |  | 76
LÁMPARAS PORTÁTILES
HAND LAMPS |
| 77
LÁMPARAS PORTÁTILES
FLUORESCENTES
HAND LAMP FLUORESCENT |  |  | 77
EXTENSIBLES ELÉCTRICOS
CABLE REEL |
| 78
BASES MÚLTIPLES
MULTIPLE SOCKETS |  |  | 81
EXTENSIBLES ELÉCTRICOS
CABLE REEL |
| 82
EXTENSIBLES ELÉCTRICOS
INDUSTRIALES
INDUSTRY CABLE REEL |  |  | 90
EXTENSIBLES ELÉCTRICOS
PARA INSTALADORES
CABLE REEL FOR ELECTRICAL INSTALLERS |

TODOS LOS ACCESORIOS ELÉCTRICOS LLEVAN MARCADO CE

CUMPLEN CON LA DIRECTIVA DE BAJA TENSIÓN 2006/95/CE
CUMPLEN CON LA DIRECTIVA DE COMPATIBILIDAD ELECTROMAGNÉTICA 2004/108/CE

Prolongadores Eléctricos

Extension Cables



CÓDIGO CODE	570001	571008	572005
CABLE CABLE	H05VV-F 3G1,5 2 m	H05VV-F 3G1,5 3 m	H05VV-F 3G1,5 4 m
POT. MÁX MAX. POWER	250V~16A 3.500W	250V~16A 3.500W	250V~16A 3.500W
CLAVIJA Y BASE PLUG AND SOCKET	2P+T	2P+T	2P+T
UNID. DE EMBALAJE PACK. UNIT.	10	10	10
MEDIDAS EMBALAJE PACKING SIZES	315x175x200 mm	325x177x205 mm	310x165x247 mm



CÓDIGO CODE	575006	576003	577000
CABLE CABLE	H05VV-F 3G1,5 10 m	H05VV-F 3G1,5 15 m	H05VV-F 3G1,5 25 m
POT. MÁX MAX. POWER	250V~16A 3.500W	250V~16A 3.500W	250V~16A 3.500W
CLAVIJA Y BASE PLUG AND SOCKET	2P+T	2P+T	2P+T
UNID. DE EMBALAJE PACK. UNIT.	6	6	6
MEDIDAS EMBALAJE PACKING SIZES	370x200x172 mm	390x210x205 mm	430x220x215 mm



Lámparas Portátiles (De Bombilla)

Hand Lamps

Portátil con cable, clavija y mango de GOMA.
 Hand lamp with rubber cable, plug and handle

CÓDIGO CODE	586002
CABLE CABLE	H07RN-F 2X1 10 m
POT. MÁX MAX. POWER	Bombilla 60 W 230V~
UNID. DE EMBALAJE PACK. UNIT.	10
MEDIDAS EMBALAJE PACKING SIZES	765x365x200 mm



IP54



Lámparas Portátiles Fluorescentes

Fluorescents Work Lamps



IP54



Fluorescente 11W con cable y clavija de GOMA, y chasis de PP
Fluorescent 11W with rubber cable and plug, and PP spool

CÓDIGO CODE	583001
CABLE CABLE	H07RN-F 2X1 5 m
POT. MÁX MAX. POWER	Fluorescente 11 W 230V~
UNID. DE EMBALAJE PACK. UNIT.	10
MEDIDAS EMBALAJE PACKING SIZES	505x480x135 mm



Lámparas Portátiles Leds

Leds Work Lamps

Portátil con 60 LEDs Incluye cargador estándar y cargador de coche
Work lamp with 60 LEDs With adaptor and cigarette plug

CÓDIGO CODE	589607
BATERÍA RECARGABLE RECHARGABLE BATTERY	Ni-MH 600mAh 7,2V
ENTRADA INPUT	100-250V AC 50/60 Hz
SALIDA OUTPUT	9V DC 300 mA
TIEMPO DE CARGA CHARGING TIME	4-5 horas
AUTONOMÍA BATTERY LONG LIFE	3 horas
UNID. DE EMBALAJE PACK. UNIT.	6
MEDIDAS EMBALAJE PACKING SIZES	520x330x145 mm



RECHARGABLE
RECHARGABLE



Bases Múltiples

Multiple Sockets



CE 3 bases 2P+T
3 sockets 2P+T



CE 3 bases 2P+T con interruptor
3 sockets 2P+T with switch



CÓDIGO CODE	800009	801006
CABLE CABLE	H05VV-F 3G1 1,4 m	H05VV-F 3G1 1,4 m
POT. MÁX MAX. POWER	10/16 A 250 V ~3.500W	10/16 A 250 V ~3.500W
UNID. DE EMBALAJE PACK. UNIT.	10	10
MEDIDAS EMBALAJE PACKING SIZES	245x235x155 mm	255x255x155 mm



CE 4 bases 2P+T
4 sockets 2P+T



CE 4 bases 2P+T con interruptor
4 sockets 2P+T with switch



CÓDIGO CODE	805004	806001
CABLE CABLE	H05VV-F 3G1 1,4 m	H05VV-F 3G1 1,4 m
POT. MÁX MAX. POWER	10/16 A 250 V ~3.500W	10/16 A 250 V ~3.500W
UNID. DE EMBALAJE PACK. UNIT.	10	10
MEDIDAS EMBALAJE PACKING SIZES	275x230x155 mm	300x230x155 mm



CE 5 bases 2P+T
5 sockets 2P+T



CE 5 bases 2P+T con interruptor
5 sockets 2P+T with switch



CÓDIGO CODE	807008	808005
CABLE CABLE	H05VV-F 3G1 1,4 m	H05VV-F 3G1 1,4 m
POT. MÁX MAX. POWER	10/16 A 250 V ~3.500W	10/16 A 250 V ~3.500W
UNID. DE EMBALAJE PACK. UNIT.	10	10
MEDIDAS EMBALAJE PACKING SIZES	320x235x155 mm	340x255x155 mm



CE 6 bases 2P+T
6 sockets 2P+T



CE 6 bases 2P+T con interruptor
6 sockets 2P+T with switch



CÓDIGO CODE	810008	811005
CABLE CABLE	H05VV-F 3G1 1,4 m	H05VV-F 3G1 1,4 m
POT. MÁX MAX. POWER	10/16 A 250 V ~3.500W	10/16 A 250 V ~3.500W
UNID. DE EMBALAJE PACK. UNIT.	10	10
MEDIDAS EMBALAJE PACKING SIZES	360x255x155 mm	380x255x155 mm



Bases Múltiples

Multiple Sockets



4 bases 2P+T con interruptor y protección sobre-tensión
 CE 4 sockets 2P+T with switch and voltage protection

CÓDIGO CODE	814600
CABLE CABLE	H05VV-F 3G1,5 1,5 m
POT. MÁX MAX. POWER	16 A 250 V ~3.500W
UNID. DE EMBALAJE PACK. UNIT.	6
MEDIDAS EMBALAJE PACKING SIZES	450x235x120 mm



6 bases 2P+T con interruptor y protección sobre-tensión
 CE 6 sockets 2P+T with switch and voltage protection

CÓDIGO CODE	816604
CABLE CABLE	H05VV-F 3G1,5 1,5 m
POT. MÁX MAX. POWER	16 A 250 V ~3.500W
UNID. DE EMBALAJE PACK. UNIT.	6
MEDIDAS EMBALAJE PACKING SIZES	530x235x120 mm



8 bases 2P+T con interruptor y protección sobre-tensión
 CE 8 sockets 2P+T with switch and voltage protection

CÓDIGO CODE	818608
CABLE CABLE	H05VV-F 3G1,5 1,5 m
POT. MÁX MAX. POWER	16 A 250 V ~3.500W
UNID. DE EMBALAJE PACK. UNIT.	6
MEDIDAS EMBALAJE PACKING SIZES	620x235x120 mm

Bases Múltiples

Multiple Sockets

GOMA-NEOPRENO
RUBBER-NEOPRENO



4 bases 2P+T con tapa e interruptor
4 sockets 2P+T with cover and switch

CÓDIGO CODE	834004
CABLE CABLE	H07RN-F 3G1.5 2m (Goma-Neopreno) H07RN-F 3G1.5 2m (Rubber-Neopreno)
POT. MÁX MAX. POWER	16 A 250 V ~3.500W
UNID. DE EMBALAJE PACK. UNIT.	6
MEDIDAS EMBALAJE PACKING SIZES	360x200x240 mm



6 bases 2P+T con tapa e interruptor
6 sockets 2P+T with cover and switch

CÓDIGO CODE	836008
CABLE CABLE	H07RN-F 3G1.5 2m (Goma-Neopreno) H07RN-F 3G1.5 2m (Rubber-Neopreno)
POT. MÁX MAX. POWER	16 A 250 V ~3.500W
UNID. DE EMBALAJE PACK. UNIT.	6
MEDIDAS EMBALAJE PACKING SIZES	480x200x243 mm



HOGAR-BRICOLAGE
HOME-DIY

CE

CÓDIGO CODE	714009
CABLE CABLE	H05VV-F 3G1,0 5 m
BASES SOCKETS	2 (2P+T) con termostato 2 (2P+T) with thermostat
POT. MÁX MAX. POWER	250 V ~ 10A 2.500W
UNID. DE EMBALAJE PACK. UNIT.	6
MEDIDAS EMBALAJE PACKING SIZES	345x250x225 mm



CE

CÓDIGO CODE	729218
CABLE CABLE	H05VV-F 3G1,0 10 m
BASES SOCKETS	4 (2P+T) con termostato 4 (2P+T) with thermostat
POT. MÁX MAX. POWER	250 V ~ 10A 2.500W
UNID. DE EMBALAJE PACK. UNIT.	6
MEDIDAS EMBALAJE PACKING SIZES	395x310x255 mm



CE

CÓDIGO CODE	734007
CABLE CABLE	H05VV-F 3G1,0 15 m
BASES SOCKETS	4 (2P+T) con termostato 4 (2P+T) with thermostat
POT. MÁX MAX. POWER	250 V ~ 10A 2.500W
UNID. DE EMBALAJE PACK. UNIT.	6
MEDIDAS EMBALAJE PACKING SIZES	395x310x255 mm



Extensibles Eléctricos

Cable Reel

TALLER-INDUSTRIAS
WORKSHOP-INDUSTRY



CE

CÓDIGO CODE	749001
CABLE CABLE	H05VV-F 3G1,5 15 m
BASES SOCKETS	4 (2P+T) con termostato 4 (2P+T) with thermostat
POT. MÁX MAX. POWER	250 V ~ 16A 3.500W
DIÁMETRO DE CARRETE PACK. UNIT.	215 mm
UNID. DE EMBALAJE PACK. UNIT.	2
MEDIDAS EMBALAJE PACKING SIZES	348x224x300 mm
UNID. BOX-PALET BOX-PALET UNIT.	80
MEDIDAS EMBALAJE PACKING SIZES	1100x680x1164 mm



CE

CÓDIGO CODE	752001
CABLE CABLE	H05VV-F 3G1 25 m
BASES SOCKETS	4 (2P+T) con termostato 4 (2P+T) with thermostat
POT. MÁX MAX. POWER	250 V ~ 16A 2.500W
DIÁMETRO DE CARRETE PACK. UNIT.	215 mm
UNID. DE EMBALAJE PACK. UNIT.	2
MEDIDAS EMBALAJE PACKING SIZES	348x224x300 mm
UNID. BOX-PALET BOX-PALET UNIT.	80
MEDIDAS EMBALAJE PACKING SIZES	1100x680x1164 mm

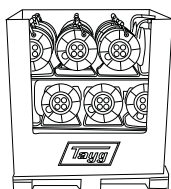

Extensibles Eléctricos

Cable Reel

**SOPORTE METÁLICO
CARRETE DE PLÁSTICO**
METAL FRAME
PLASTIC SPOOL



CE

CÓDIGO CODE	771002
CABLE CABLE	H05VV-F 3G1,5 25 m
BASES SOCKETS	4 (2P+T) con termostato 4 (2P+T) with thermostat
POT. MÁX MAX. POWER	250 V ~ 16A 3.500W
DIÁMETRO DE CARRETE PACK. UNIT.	230 mm
UNID. DE EMBALAJE PACK. UNIT.	2
MEDIDAS EMBALAJE PACKING SIZES	405x235x310 mm
UNID. BOX-PALET BOX-PALET UNIT.	60
MEDIDAS BOX-PALET BOX-PALET SIZES	1110x740x930 mm



CE

CÓDIGO CODE	778001
CABLE CABLE	H05VV-F 3G1,5 50 m
BASES SOCKETS	4 (2P+T) con termostato 4 (2P+T) with thermostat
POT. MÁX MAX. POWER	250 V ~ 16A 3.500W
DIÁMETRO DE CARRETE PACK. UNIT.	250 mm
UNID. DE EMBALAJE PACK. UNIT.	1
MEDIDAS EMBALAJE PACKING SIZES	265x214x334 mm
UNID. BOX-PALET BOX-PALET UNIT.	48
MEDIDAS BOX-PALET BOX-PALET SIZES	1020x805x1000 mm

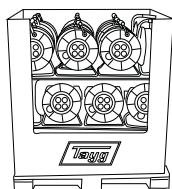

**IP-20
3.500 W**

Extensibles Eléctricos

Cable Reel

SOPORTE Y CARRETE METÁLICO

METAL FRAME AND SPOOL



CE

CÓDIGO CODE	770500
CABLE CABLE	H05VV-F 3G1,5 25 m
BASES SOCKETS	4 (2P+T) con termostato 4 (2P+T) with thermostat
POT. MÁX MAX. POWER	250 V ~ 16A 3.500W
DIÁMETRO DE CARRETE PACK. UNIT.	255 m
UNID. DE EMBALAJE PACK. UNIT.	1
MEDIDAS EMBALAJE PACKING SIZES	265x214x334 mm
UNID. BOX-PALET BOX-PALET UNIT.	48
MEDIDAS BOX-PALET BOX-PALET SIZES	1020x805x1000 mm



CE

CÓDIGO CODE	775505
CABLE CABLE	H05VV-F 3G1,5 50 m
BASES SOCKETS	4 (2P+T) con termostato 4 (2P+T) with thermostat
POT. MÁX MAX. POWER	250 V ~ 16A 3.500W
DIÁMETRO DE CARRETE PACK. UNIT.	255 m
UNID. DE EMBALAJE PACK. UNIT.	1
MEDIDAS EMBALAJE PACKING SIZES	265x214x334 mm
UNID. BOX-PALET BOX-PALET UNIT.	48
MEDIDAS BOX-PALET BOX-PALET SIZES	1020x805x1000 mm



**IP-20
3.500 W**

Extensibles Eléctricos

Cable Reel

SOPORTE METÁLICO
CARRETE DE PLÁSTICO
METAL FRAME
PLASTIC SPOOL



CE

CÓDIGO CODE	770609
CABLE CABLE	H05VV-F 3G1,5 25 m
BASES SOCKETS	4 (2P+T) con termostato 4 (2P+T) with thermostat
POT. MÁX MAX. POWER	230 V ~ 13A 3.000W
DIÁMETRO DE CARRETE PACK. UNIT.	230 m
UNID. DE EMBALAJE PACK. UNIT.	1
MEDIDAS EMBALAJE PACKING SIZES	245x225x320 mm



CE

CÓDIGO CODE	775604
CABLE CABLE	H05VV-F 3G1,5 50 m
BASES SOCKETS	4 (2P+T) con termostato 4 (2P+T) with thermostat
POT. MÁX MAX. POWER	230 V ~ 13A 3.000W
DIÁMETRO DE CARRETE PACK. UNIT.	265 m
UNID. DE EMBALAJE PACK. UNIT.	1
MEDIDAS EMBALAJE PACKING SIZES	285x225x355 mm



IP-20
3.000 W

Extensibles Eléctricos

Cable Reel

SOPORTE METÁLICO CARRETE PLÁSTICO

METAL FRAME
PLASTIC SPOOL



CE

CÓDIGO CODE	765605
CABLE CABLE	H05VV-F 3G1,5 25 m
BASES SOCKETS	4 (2P+T) con termostato con tapa 4 (2P+T) with thermostat and cover
POT. MÁX MAX. POWER	230 V ~ 13A 3.000W
DIÁMETRO DE CARRETE PACK. UNIT.	265 m
UNID. DE EMBALAJE PACK. UNIT.	1
MEDIDAS EMBALAJE PACKING SIZES	285x225x355 mm



CE

CÓDIGO CODE	766602
CABLE CABLE	H05VV-F 3G1,5 50 m
BASES SOCKETS	4 (2P+T) con termostato con tapa 4 (2P+T) with thermostat and cover
POT. MÁX MAX. POWER	230 V ~ 13A 3.000W
DIÁMETRO DE CARRETE PACK. UNIT.	265 m
UNID. DE EMBALAJE PACK. UNIT.	1
MEDIDAS EMBALAJE PACKING SIZES	285x225x355 mm



IP-44
3.000 W

Extensibles Eléctricos

Cable Reel

SOPORTE METÁLICO
CARRETE DE PLÁSTICO
METAL FRAME
PLASTIC SPOOL
AÉREO



CE

CÓDIGO CODE	773600
CABLE CABLE	H05VV-F 3G1,5 25 m
BASES SOCKETS	Aérea
POT. MÁX MAX. POWER	230 V ~ 3.200W
DIÁMETRO DE CARRETE PACK. UNIT.	230 m
UNID. DE EMBALAJE PACK. UNIT.	1
MEDIDAS EMBALAJE PACKING SIZES	255x200x345 mm



**IP-20
3.200 W**

Extensibles Eléctricos

Cable Reel

SOPORTE METÁLICO CARRETE DE PLÁSTICO

METAL FRAME
PLASTIC SPOOL



CE

CÓDIGO CODE	765001
CABLE CABLE	H05VV-F 3G1,5 25 m
BASES SOCKETS	3 (2P+T) con termostato y tapa 3 (2P+T) with thermostat and cover
POT. MÁX MAX. POWER	250 V ~ 16A 3.500W
DIÁMETRO DE CARRETE PACK. UNIT.	290 mm
UNID. DE EMBALAJE PACK. UNIT.	1
MEDIDAS EMBALAJE PACKING SIZES	315x214x390 mm
UNID. BOX-PALET BOX-PALET UNIT.	42
MEDIDAS BOX-PALET BOX-PALET SIZES	1122x805x1160 mm



CE

CÓDIGO CODE	766008
CABLE CABLE	H05VV-F 3G1,5 50 m
BASES SOCKETS	3 (2P+T) con termostato y tapa 3 (2P+T) with thermostat and cover
POT. MÁX MAX. POWER	250 V ~ 16A 3.500W
DIÁMETRO DE CARRETE PACK. UNIT.	290 mm
UNID. DE EMBALAJE PACK. UNIT.	1
MEDIDAS EMBALAJE PACKING SIZES	315x214x390 mm
UNID. BOX-PALET BOX-PALET UNIT.	42
MEDIDAS BOX-PALET BOX-PALET SIZES	1122x805x1160 mm

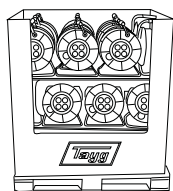

IP-55
3.500 W

Extensibles Eléctricos

Cable Reel



CE



CE

SOPORTE Y CARRETE METÁLICO
METAL FRAME AND SPOOL

CÓDIGO CODE	785511
CABLE CABLE	H05VV-F 3G2,5 25 m
BASES SOCKETS	3 (2P+T) con termostato y tapa 3 (2P+T) with thermostat and cover
POT. MÁX MAX. POWER	250 V ~ 16A 4.000W
DIÁMETRO DE CARRETE PACK. UNIT.	255 m
UNID. DE EMBALAJE PACK. UNIT.	1
MEDIDAS EMBALAJE PACKING SIZES	265x214x334 mm
UNID. BOX-PALET BOX-PALET UNIT.	48
MEDIDAS BOX-PALET BOX-PALET SIZES	1020x805x1000 mm

CÓDIGO CODE	786518
CABLE CABLE	H05VV-F 3G2,5 50 m
BASES SOCKETS	3 (2P+T) con termostato y tapa 3 (2P+T) with thermostat and cover
POT. MÁX MAX. POWER	250 V ~ 16A 4.000W
DIÁMETRO DE CARRETE PACK. UNIT.	310 m
UNID. DE EMBALAJE PACK. UNIT.	1
MEDIDAS EMBALAJE PACKING SIZES	315x214x390 mm
UNID. BOX-PALET BOX-PALET UNIT.	42
MEDIDAS BOX-PALET BOX-PALET SIZES	1122x805x1160 mm



IP-55
4.000 W

Extensibles Eléctricos

Cable Reel

SOPORTE Y CARRETE METÁLICO

METAL FRAME AND SPOOL



CE

CÓDIGO CODE	765506
CABLE CABLE	H07RN-F 3G1,5 25 m Goma/Neopreno
BASES SOCKETS	3 (2P+T) con termostato y tapa 3 (2P+T) with thermostat and cover
POT. MÁX MAX. POWER	250 V ~ 16A 3.500W
DIÁMETRO DE CARRETE PACK. UNIT.	255 m
UNID. DE EMBALAJE PACK. UNIT.	1
MEDIDAS EMBALAJE PACKING SIZES	265x214x334 mm



CE

CÓDIGO CODE	766503
CABLE CABLE	H07RN-F 3G1,5 50 m Goma/Neopreno
BASES SOCKETS	3 (2P+T) con termostato y tapa 3 (2P+T) with thermostat and cover
POT. MÁX MAX. POWER	250 V ~ 16A 3.500W
DIÁMETRO DE CARRETE PACK. UNIT.	310 m
UNID. DE EMBALAJE PACK. UNIT.	1
MEDIDAS EMBALAJE PACKING SIZES	315x214x390 mm



IP-55
3.500 W

CABLE GOMA NEOPRENO
EXTERIORES
Cable rubber neoprene
exteriors

Para instaladores eléctricos:
For electrical installers:

Cumple con la Instrucción Técnica
Complementaria nº33 del
Reglamento de Baja Tensión.

Comply with Complementary Technical
Instruction no 33 of the Spanish Low Voltage
Electrical Installation Regulations.

SOPORTE Y CARRETE METÁLICO
METAL FRAME AND SPOOL



CE

CÓDIGO CODE	767500
CABLE CABLE	H07RN-F 3G1,5 25 m Goma/Neopreno
BASES SOCKETS	2 (2P+T) con termostato y tapa 2 (2P+T) with thermostat and cover
POT. MÁX MAX. POWER	250 V ~ 16A 3.500W
DIÁMETRO DE CARRETE PACK. UNIT.	255 m
UNID. DE EMBALAJE PACK. UNIT.	1
MEDIDAS EMBALAJE PACKING SIZES	265x214x334 mm

CABLE GOMA NEOPRENO
Rubber-neoprene cable



 **IP-67**
3.500 W

Para instaladores eléctricos:
For electrical installers:

Cumple con la Instrucción Técnica
Complementaria nº33 del
Reglamento de Baja Tensión.

Comply with Complementary Technical
Instruction no 33 of the Spanish Low Voltage
Electrical Installation Regulations.



Extensibles Eléctricos

Cable Reel

SOPORTE Y CARRETE METÁLICO

METAL FRAME AND SPOOL

TRIFÁSICOS



CE

CÓDIGO CODE	760518
CABLE CABLE	H05VV-F 4G1,5 25 m
BASES SOCKETS	2 (3P+T6h 380V) con termostato y tapa 2 (3P+T6h 380V) with thermostat and cover
POT. MÁX MAX. POWER	380 V ~ 16A 7.000W
DIÁMETRO DE CARRETE PACK. UNIT.	255 m
UNID. DE EMBALAJE PACK. UNIT.	1
MEDIDAS EMBALAJE PACKING SIZES	265x214x334 mm



CE

CÓDIGO CODE	780516
CABLE CABLE	H05VV-F 4G1,5 50 m
BASES SOCKETS	2 (3P+T6h 380V) con termostato y tapa 2 (3P+T6h 380V) with thermostat and cover
POT. MÁX MAX. POWER	380 V ~ 16A 7.000W
DIÁMETRO DE CARRETE PACK. UNIT.	310 m
UNID. DE EMBALAJE PACK. UNIT.	1
MEDIDAS EMBALAJE PACKING SIZES	315x214x390 mm



IP-44
7.000 W



BUREAU VERITAS
Certification

Certificación Certification

Concedida a / Awarded to

INDUSTRIAS TAYG SL

AVENIDA REAL DE MADRID NORTE, 70
46469 BENIPARRELL
SPAIN

Bureau Veritas certifica que el Sistema de Gestión ha sido auditado y encontrado conforme con los requisitos de la norma:

Bureau Veritas certify that the Management System has been audited and found to be in accordance with the requirements of standard:

NORMA / STANDARD

ISO 9001:2008

El Sistema de Gestión se aplica a:

Scope of certification:

DISEÑO Y FABRICACIÓN DE ARTÍCULOS DE PLÁSTICO PARA FERRETERÍA Y BRICOLAJE. COMERCIALIZACIÓN DE ARTÍCULOS PARA FERRETERÍA Y BRICOLAJE

DESIGN AND PRODUCTION OF PLASTIC ARTICLES FOR HARDWARE AND D.I.Y. COMMERCIALIZATION OF PRODUCTS FOR HARDWARE AND D.I.Y.

Número del Certificado
Certificate Number

ES042955-1

Director General / General Manager
Bureau Veritas Certification, S.A.

Aprobación original:
Original approval date:

10/07/2009

Certificado en vigor:
Effective date:

11/07/2012

caducidad del certificado:
Certificate expiration date:

10/07/2015

Este certificado está sujeto a los términos y condiciones generales y particulares de los servicios de certificación. This certificate is valid, subject to the general and specific terms and conditions of certification services.



Manejo Oficial Oficina Central: Bureau Veritas Certification, S.A.
Issuing Office Oficina de emisión: Bureau Veritas Certification, S.A.

C/ Valentín Píñeros 22-24, Edificio Cooke, Pol. Ind. La Graya, 28109 Alcobendas Madrid





Tayg

INDUSTRIAS TAYG, S.L.

Avda. Real de Madrid Norte , nº70 · 46469 Beniparrell · Valencia · España
T +34 96 121 24 62 · F +34 96 121 23 38
industriastayg@tayg.es · www.tayg.es
039°-23, 24´N · 000°-24, 62´O

ATENCIÓN AL CLIENTE Y PEDIDOS:
T 96 121 24 62 · F 96 121 23 38
pedidos@tayg.es

INTERNATIONAL SALES:
T +34 96 121 24 62 · F +34 96 121 23 38
sales@tayg.es

CONTABILIDAD:
T 96 121 93 47 · F 96 121 23 38
admonclientes@tayg.es