



BL Series  
LCD Monitor  
User Manual



## Copyright

Copyright © 2014 by BenQ Corporation. All rights reserved. No part of this publication may be reproduced, transmitted, transcribed, stored in a retrieval system or translated into any language or computer language, in any form or by any means, electronic, mechanical, magnetic, optical, chemical, manual or otherwise, without the prior written permission of BenQ Corporation.

## Disclaimer

BenQ Corporation makes no representations or warranties, either expressed or implied, with respect to the contents hereof and specifically disclaims any warranties, merchantability or fitness for any particular purpose. Further, BenQ Corporation reserves the right to revise this publication and to make changes from time to time in the contents hereof without obligation of BenQ Corporation to notify any person of such revision or changes.

The performance of flicker-free may be affected by external factors such as poor cable quality, unstable power supply, signal interference, or poor grounding, and not limited to the above mentioned external factors. (Applicable for flicker-free models only.)

## Power Safety



Please follow these safety instructions for best performance, and long life for your monitor.

---

- The AC plug isolates this equipment from the AC supply.
- The power supply cord serves as a power disconnect device for pluggable equipment. The socket outlet should be installed near the equipment and be easily accessible.
- This product should be operated from the type of power indicated on the marked label. If you are not sure of the type of power available, consult your dealer or local power company.
- An approved power cord greater or equal to H03VV-F or H05VV-F, 2G or 3G, 0.75mm<sup>2</sup> must be used.

## Care And Cleaning

- **Cleaning.** Always unplug your monitor from the wall outlet before cleaning. Clean the LCD monitor surface with a lint-free, non-abrasive cloth. Avoid using any liquid, aerosol or glass cleaners.
- Slots and openings on the back or top of the cabinet are for ventilation. They must not be blocked or covered. Your monitor should never be placed near or over a radiator or heat source, or in a built-in installation unless proper ventilation is provided.
- Never push objects or spill liquid of any kind into this product.

## Servicing

Do not attempt to service this product yourself, as opening or removing covers may expose you to dangerous voltages or other risks. If any of the above mentioned misuse or other accident such as dropping or mishandling occurs, contact qualified service personnel for servicing.

## BenQ ecoFACTS

BenQ has been dedicated to the design and development of greener product as part of its aspiration to realize the ideal of the "Bringing Enjoyment 'N Quality to Life" corporate vision with the ultimate goal to achieve a low-carbon society. Besides meeting international regulatory requirement and standards pertaining to environmental management, BenQ has spared no efforts in pushing our initiatives further to incorporate life cycle design in the aspects of material selection, manufacturing, packaging, transportation, using and disposal of the products. BenQ ecoFACTS label lists key eco-friendly design highlights of each product, hoping to ensure that consumers make informed green choices at purchase. Check out BenQ's CSR Website at <http://csr.BenQ.com/> for more details on BenQ's environmental commitments and achievements.





# Table of Contents





Copyright .....	2
Getting started .....	5
Getting to know your monitor .....	7
Front view.....	7
Back view .....	7
Input and output ports.....	8
Connection .....	9
How to assemble your monitor hardware .....	10
How to detach the stand and the base .....	16
Adjusting the monitor height .....	18
Rotating the monitor .....	19
Viewing angle adjustment.....	20
Using the monitor wall mounting kit .....	21
Getting the most from your BenQ monitor .....	22
How to install the monitor on a new computer .....	23
How to upgrade the monitor on an existing computer .....	24
How to install on Windows 8 (8.1) system .....	25
How to install on Windows 7 system .....	26
How to adjust your monitor .....	27
The control panel.....	27
Basic menu operation .....	28
Picture optimization .....	30
Customizing the hot keys.....	30
Adjusting display mode .....	30
Choosing an appropriate picture mode.....	31
Connecting the monitor to your MacBook series product.....	31
Navigating the main menu .....	32
Display menu .....	33
Picture menu .....	35
Picture Advanced menu .....	37
Audio menu .....	40
System menu .....	41
Ergonomics menu .....	45
Eco menu .....	47
Troubleshooting .....	49
Frequently asked questions (FAQ) .....	49
Need more help?.....	51

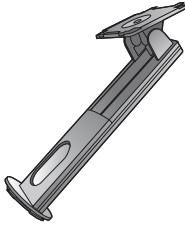
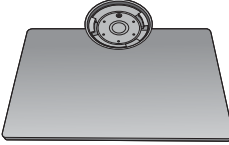
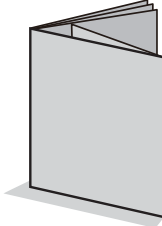

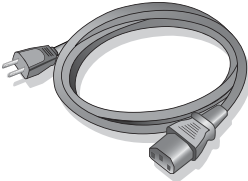
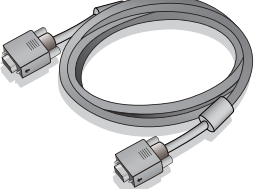
# Getting started

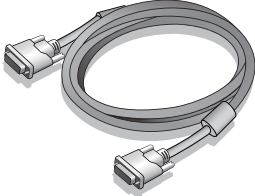
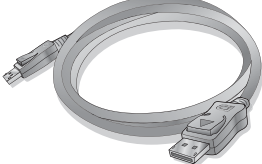
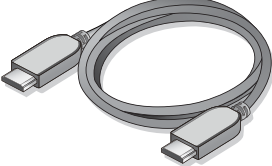
When unpacking please check you have the following items. If any are missing or damaged, please contact the place of purchase for a replacement.

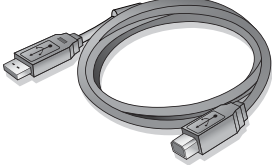
BenQ LCD Monitor	
Monitor Stand	
Monitor Base	
Quick Start Guide	
CD-ROM	
Power Cord (Picture may differ from product supplied for your region.)	
Video Cable: D-Sub	

Video Cable: DVI-D (Optional accessory, sold separately)	
Video Cable: DP (Optional accessory, sold separately)	
Video Cable: HDMI (Optional accessory, sold separately)	
Audio Cable	
USB Cable	
Headphone hook	



• Available accessories and the pictures shown here may differ from the actual contents and the product supplied for your region. For cables that are not supplied with your product, you can purchase them separately.

• Consider keeping the box and packaging in storage for use in the future when you may need to transport the monitor. The fitted foam packing is ideal for protecting the monitor during transport.



Always keep the product and accessories out of reach of small children.

# Getting to know your monitor

## Front view

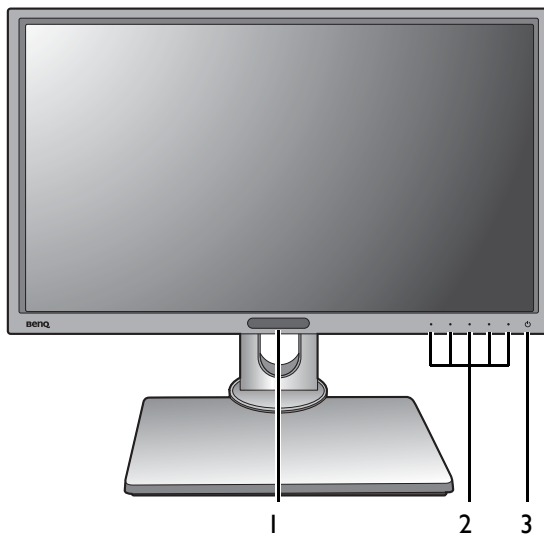

1. Light sensor / Eco sensor
2. Control buttons
3. Power button

## Back view

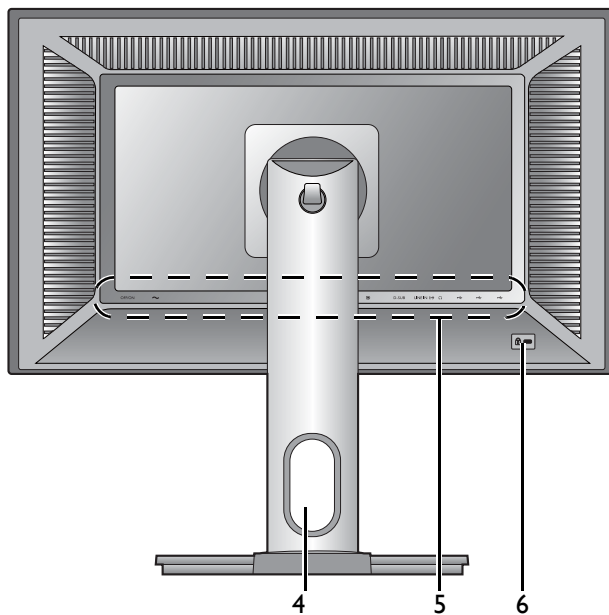

4. Cable management hole
5. Input and output ports (vary by model, see [Input and output ports on page 8](#))
6. Kensington lock slot

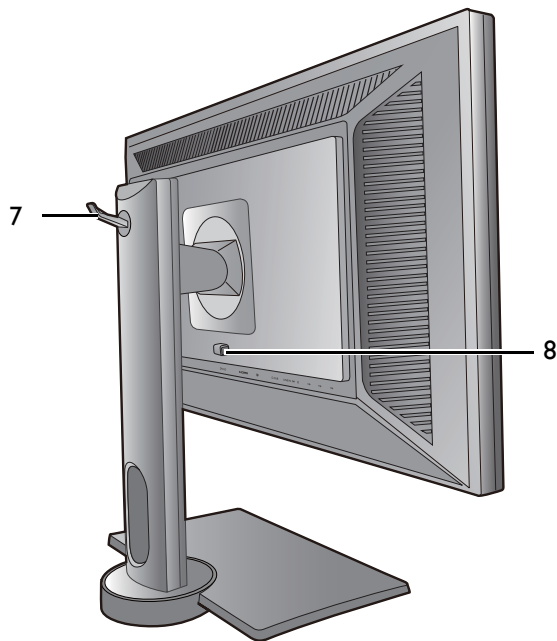

7. Headphone hook
8. VESA mount release button

## Input and output ports

Available input and output ports may vary depending on your purchased model. Check the **Specification** document on the provided CD for details.

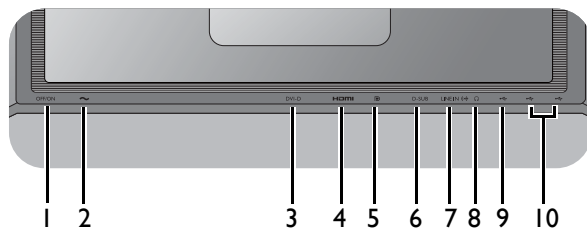

1. Power switch
2. AC power input jack
3. DVI-D socket
4. HDMI socket
5. DisplayPort socket
6. D-Sub socket
7. Audio Line In
8. Headphone jack
9. USB 2.0 port (upstream; connecting to the PC)
10. USB 2.0 port x 2 (downstream; connecting to USB devices)



- Above diagram may vary depending on the model.
- Picture may differ from product supplied for your region.

## Connection

The following connection illustrations are for your reference only. For cables that are not supplied with your product, you can purchase them separately.

For detailed connection methods, see page 12 - 13.

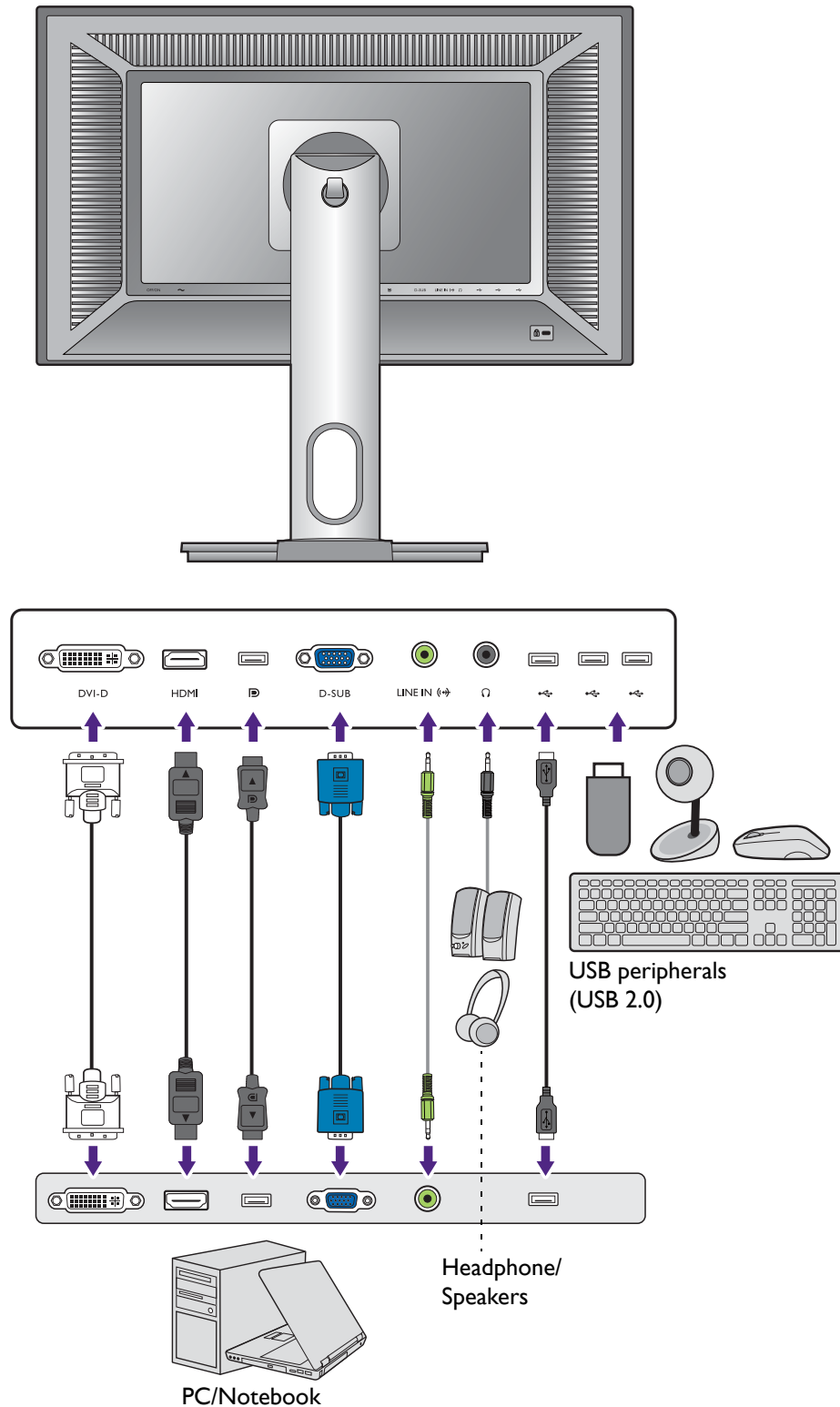

# How to assemble your monitor hardware



- If the computer is turned on you must turn it off before continuing.  
Do not plug-in or turn-on the power to the monitor until instructed to do so.
- The following illustrations are for your reference only. Available input and output jacks may vary depending on the purchased model.

## I. Attach the monitor base.



Please be careful to prevent damage to the monitor. Placing the screen surface on an object like a stapler or a mouse will crack the glass or damage the LCD substrate voiding your warranty. Sliding or scraping the monitor around on your desk will scratch or damage the monitor surround and controls.

Protect the monitor and screen by clearing a flat open area on your desk and placing a soft item like the monitor packaging bag on the desk for padding.

Gently lay the screen face down on a flat clean padded surface.

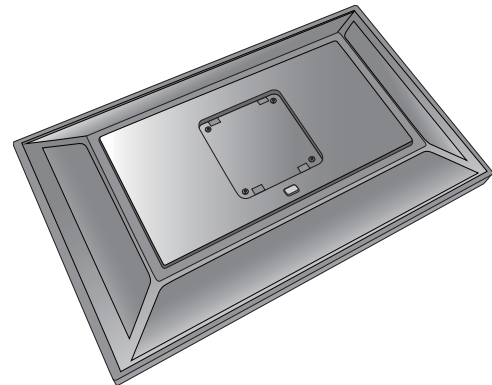

Attach the monitor stand to the monitor base as illustrated. Make sure to align the arrow on the end of the stand to the one on the monitor.

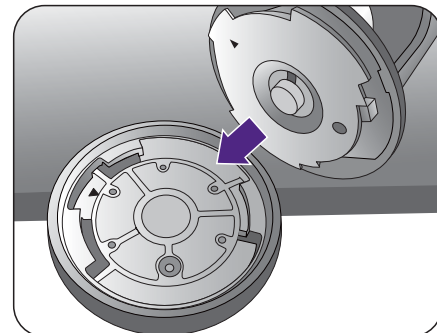

Turn the stand clockwise until you cannot go further.



Tighten the thumbscrew on the bottom of the monitor base as illustrated.

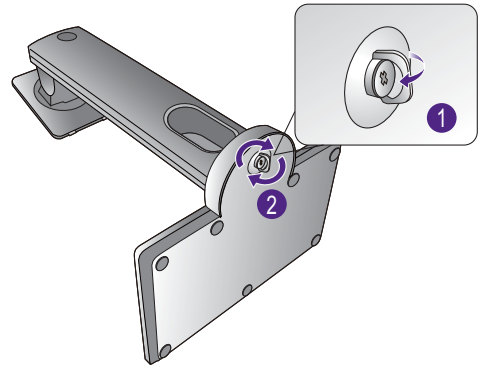

Orient and align the stand arm with the monitor (1), push them together until they click and lock into place (2).

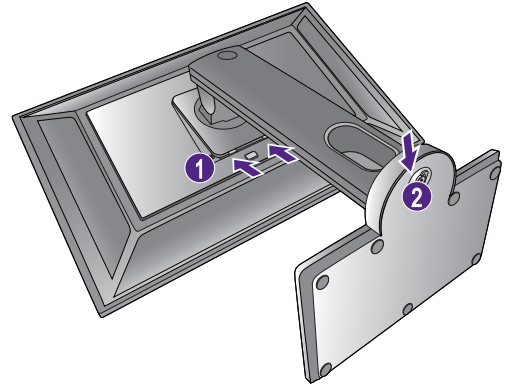

Gently attempt to pull them back apart to check that they have properly engaged.

Carefully lift the monitor, turn it over and place it upright on its stand on a flat even surface.

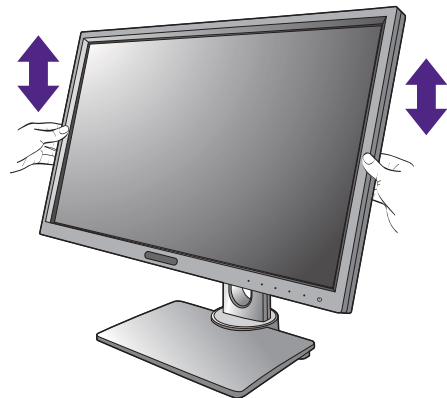

You might want to adjust the monitor stand height. See [Adjusting the monitor height on page 18](#) for more information.



You should position the monitor and angle the screen to minimize unwanted reflections from other light sources.





## 2. Connect the PC video cable.



Do not use both DVI-D cable and D-Sub cable on the same PC. The only case in which both cables can be used is if they are connected to two different PCs with appropriate video systems.

### To Connect the D-Sub Cable

Connect the plug of the D-Sub cable (at the end without the ferrite filter) to the monitor video socket. Connect the other end of the cable (at the end with the ferrite filter) to the computer video socket.

Tighten all finger screws to prevent the plugs from accidentally falling out during use.

### To Connect the DVI-D Cable

Connect the plug of the DVI-D cable (at the end without the ferrite filter) to the monitor video socket. Connect the other end of the cable (at the end with the ferrite filter) to the computer video socket.

Tighten all finger screws to prevent the plugs from accidentally falling out during use.

### To Connect the HDMI Cable

Connect the plug of the HDMI cable to the HDMI port on the monitor. Connect the other end of the cable to the HDMI port of a digital output device.

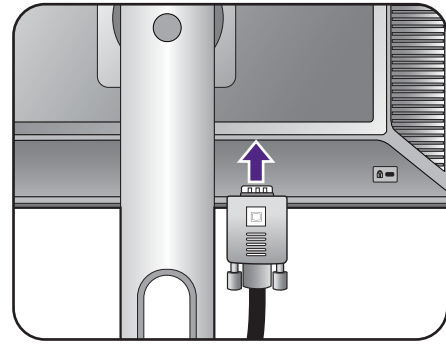

Or

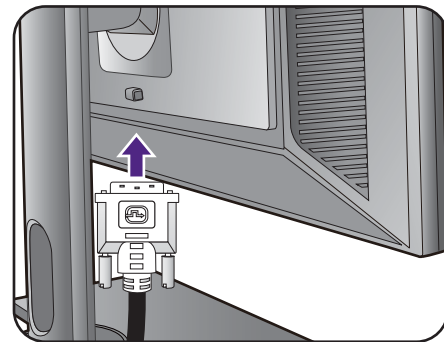

Or

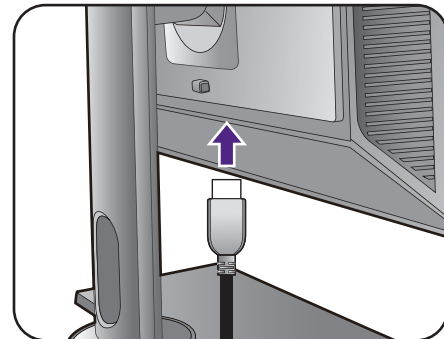

### To Connect the DP Cable

Connect the plug of the DP cable to the monitor video socket. Connect the other end of the cable to the computer video socket.

If the image is not displayed, go to **System, DisplayPort** and change the setting to **1.1**. And then connect the cable again.



If there is more than one video transmission method available to you, you might want to take the picture quality of each video cable into consideration before making the connection.

- Better quality: HDMI / DVI-D / DP
- Good quality: D-Sub



The video cables included in your package and the socket illustrations on the right may vary depending on the product supplied for your region.

### 3. Connect the audio cable.

Connect the audio cable between the socket on the rear of the monitor (Line In) and your computer audio outlet.

You may connect headphones to the headphone jack found on the back side of the monitor.

### 4. Connect USB devices.

Connect the USB cable between the PC and the monitor (via the upstream USB port at the back). This upstream USB port transmits data between the PC and the USB devices connected to the monitor.

Or

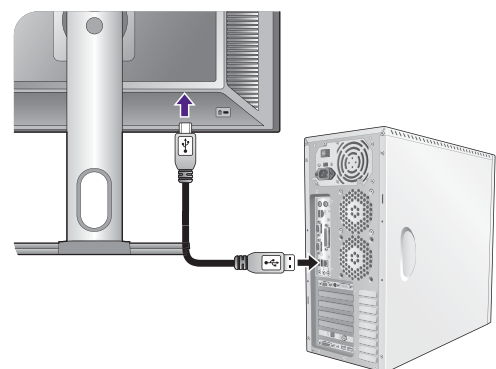
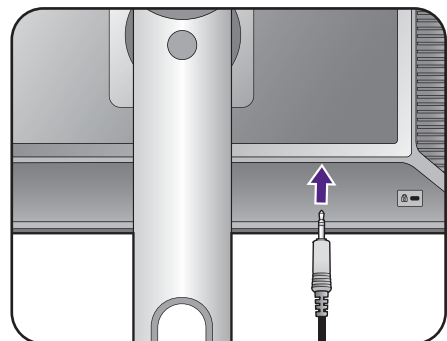
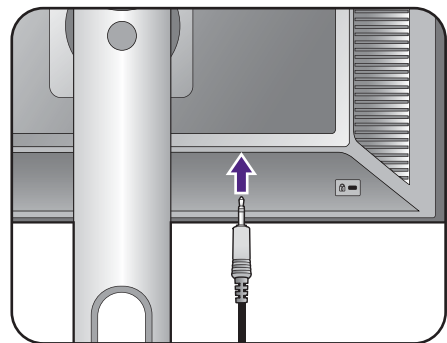
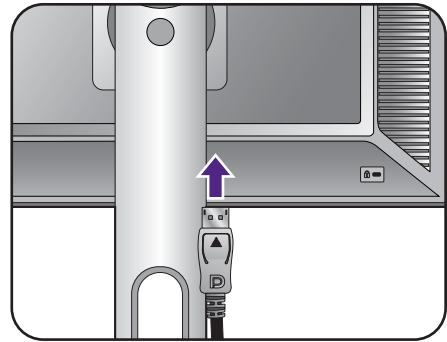

Connect USB devices via other USB ports (downstream) on the monitor. These downstream USB ports transmit data between connected USB devices and the upstream port.

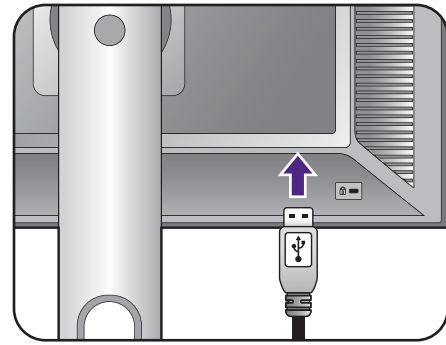

## 5. Connect the power cable to the monitor.

Plug one end of the power cord into the socket labelled  on the rear of the monitor. Do not connect the other end to a power outlet just yet.

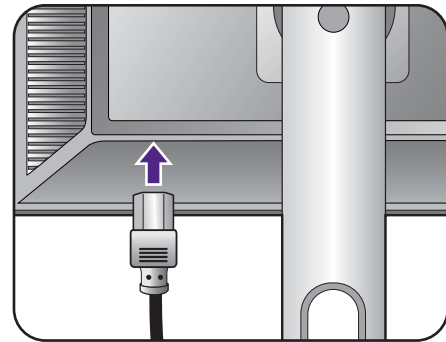

## 6. Organize the cables.

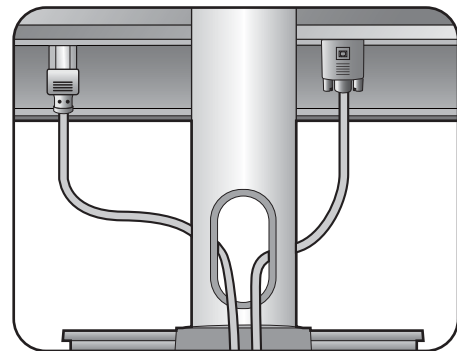

## 7. Install the headphone hook (optional step).

You can install the headphone hook to place your headphone. It is useful when your headphone is not in use.

Orient and align the headphone hook with the hole on the monitor stand, and attach the hook to the hole

(1).

Turn the hook clockwise until you cannot go further

(2). The headphone hook is ready to use.

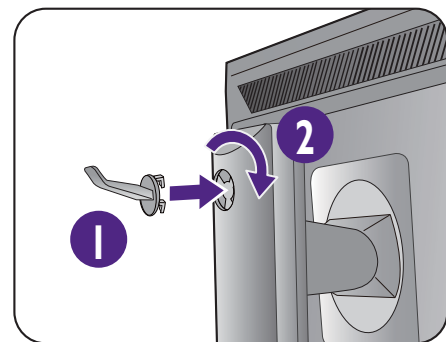

The maximum load capacity of the headphone hook is 500g.

## 8. Connect-to and turn-on the power.

Plug the other end of the power cord into a power outlet and turn it on.



Picture may differ from product supplied for your region.

Switch the power switch next to the AC power input jack to **ON**.

Turn on the monitor by pressing the power button on the monitor.

Turn on the computer too, and follow the instructions in [Getting the most from your BenQ monitor on page 22](#) to install the monitor software.



To extend the service life of the product, we recommend that you use your computer's power management function.

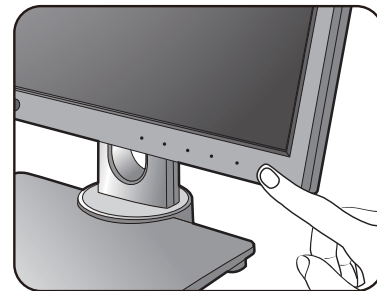
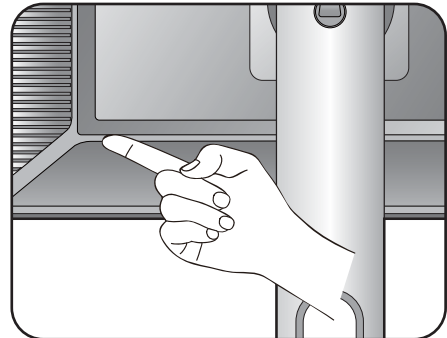
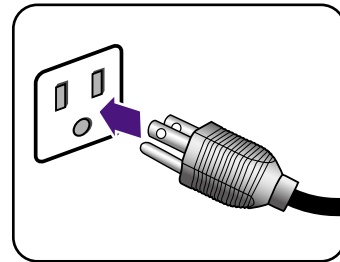

# How to detach the stand and the base

## 1. Prepare the monitor and area.

Turn off the monitor and the power before unplugging the power cable. Turn off the computer before unplugging the monitor signal cable.

Protect the monitor and screen by clearing a flat open area on your desk and placing a soft item like a towel on the desk for padding, before laying the screen face down on a flat clean padded surface.



Please be careful to prevent damage to the monitor. Placing the screen surface on an object like a stapler or a mouse will crack the glass or damage the LCD substrate voiding your warranty. Sliding or scraping the monitor around on your desk will scratch or damage the monitor surround and controls.

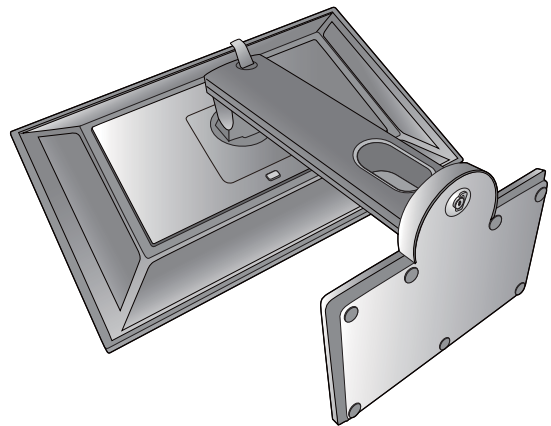

## 2. Remove the monitor stand.

While pressing and holding the VESA mount release button (1), detach the stand from the monitor (2) and (3).

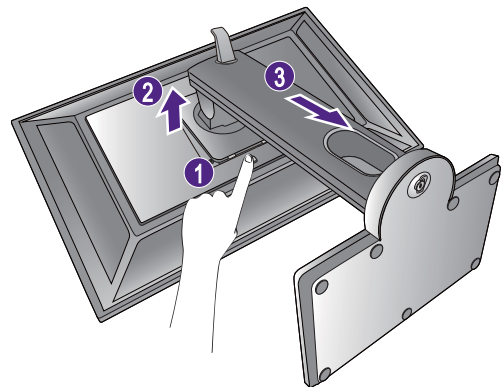

## 3. Remove the monitor base.

Release the thumbscrew on the bottom of the monitor base.

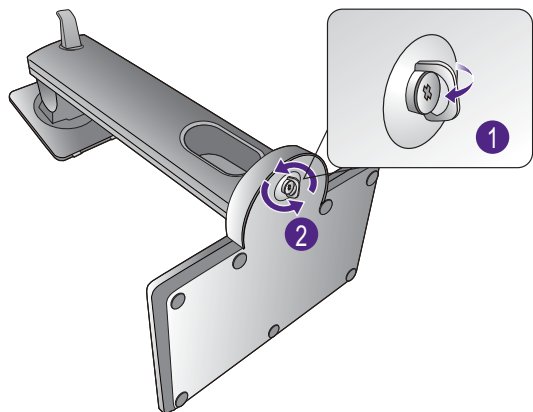

Turn the stand counterclockwise until you cannot go further.

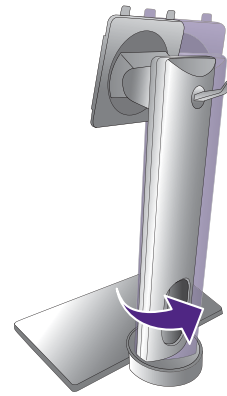

And then detach the base from the stand.

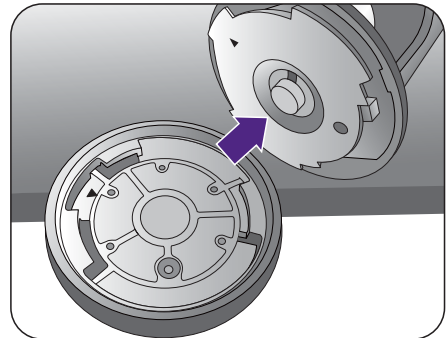

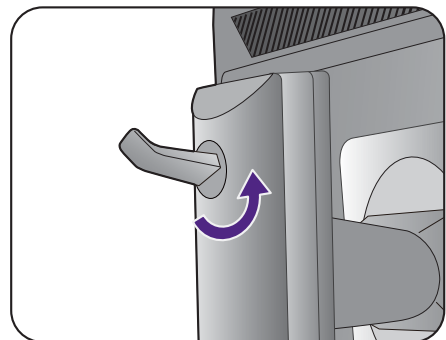

You can remove the headphone hook as illustrated. Keep the headphone hook somewhere safe.

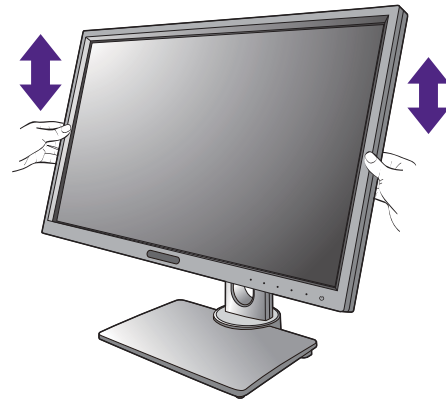

## Adjusting the monitor height

To adjust the monitor height, hold both the left and the right sides of the monitor to lower the monitor or lift it up to the desired height.



-  Avoid placing hands on the upper or lower part of the height-adjustable stand or at the bottom of the monitor, as ascending or descending monitor might cause personal injuries. Keep children out of reach of the monitor while performing this operation.

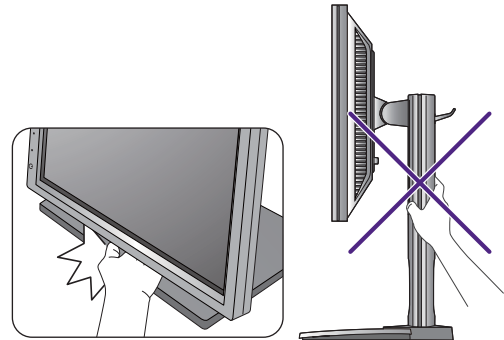

- If the monitor has been rotated to portrait mode and height adjustment is desired, you should be noted that the wide screen will keep the monitor from being lowered to its minimum height.

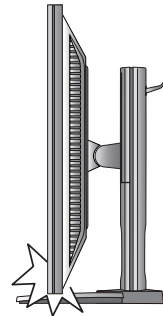



# Rotating the monitor

## 1. Pivot the display.

Before rotating the monitor with a portrait viewing orientation, the display has to be rotated 90 degrees.

Click to launch the **Display Pilot Software** (installed from [www.benq.com](http://www.benq.com)), and check **Auto Pivot** to set the display to rotate with the monitor automatically.

Alternatively, right-click the desktop and select **Screen resolution** from the popup menu. Select **Portrait** in **Orientation**, and apply the setting.



Depending on the operating system on your PC, different procedures should be followed to adjust the screen orientation. Refer to the help document of your operating system for details.

## 2. Pivot the OSD menu.

Once the display is rotated, you also need to rotate the OSD menu.

Go to **Display** and **Auto Pivot**. Select **ON**. The OSD menu rotates with the monitor.

## 3. Fully extend the monitor and tilt it.

Gently lift the display up and extend it to the maximum extended position. Then tilt the monitor.



The monitor should be vertically extended to allow to rotate from landscape to portrait mode.

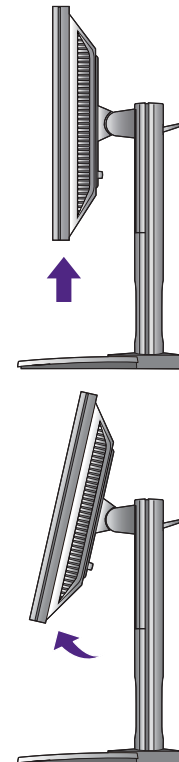

## 4. Rotate the monitor 90 degrees clockwise as illustrated.



To avoid the edge of the LCD display hitting the monitor base surface while it is being rotated, do tilt and extend the monitor to the highest position before you start to rotate the display. You should also make sure there are no obstacles around the monitor and there is enough room for cables.



5. Adjust the monitor to the desired viewing angle.



## Viewing angle adjustment

You may position the screen to the desired angle with the monitor tilt, swivel, and height adjustment functions. Refer to the product specifications for details.

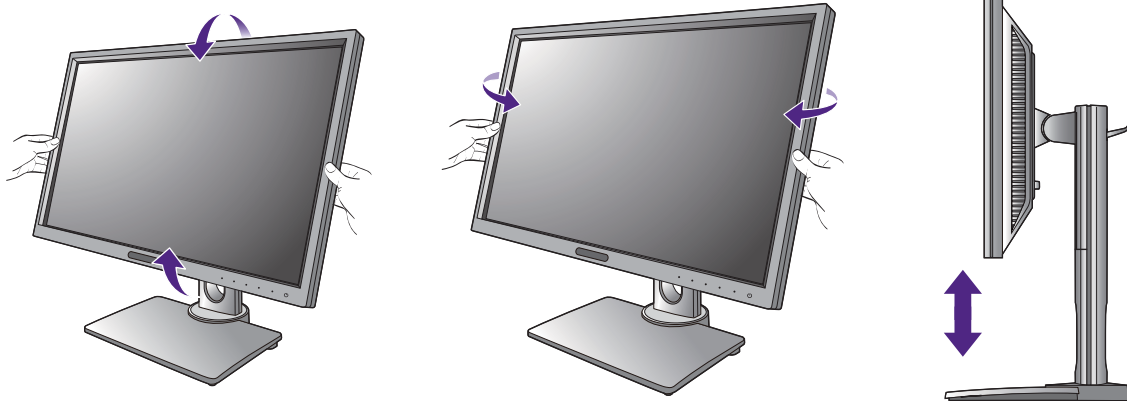

## Using the monitor wall mounting kit

The back of your LCD monitor has a VESA standard mount with 100mm pattern, allowing the installation of a wall mount bracket. Before starting to install a monitor wall mounting kit, please read the precautions carefully.

### Precautions

- Install your monitor and monitor mounting kit on a wall with flat surface.
- Ensure that the wall material is stable to support the weight of the monitor.
- Turn off the monitor and the power before disconnecting the cables from the LCD monitor.

### 1. Remove the monitor stand.

Lay the screen face down on a clean and well-padded surface. Detach the monitor stand as instructed in step 1~2 in [How to detach the stand and the base on page 16](#).

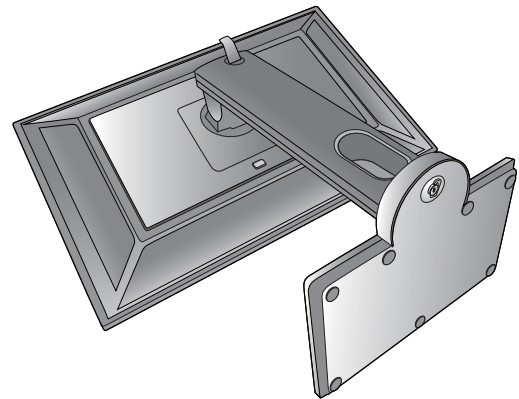

### 2. Remove the screws on the back cover.

Use a cross-pointed screwdriver to release the screws on the back cover. The use of a magnetic-head screwdriver is recommended to avoid losing the screws.

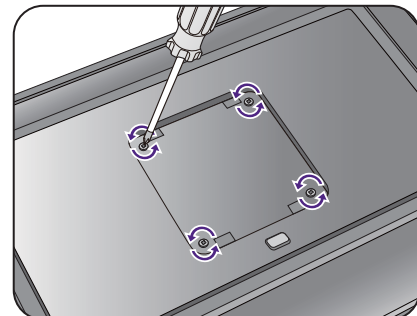

In case you intend to use your monitor on the stand in the future, please keep the monitor base, monitor stand, and screws somewhere safe for future use.

### 3. Follow the instruction manuals of the wall mount bracket you purchased to complete the installation.

## Getting the most from your BenQ monitor

To gain the most benefit from your new BenQ LCD monitor, you should install the custom BenQ LCD Monitor driver software as provided on the BenQ LCD Monitor CD-ROM.

The circumstances under which you connect and install your BenQ LCD Monitor will determine which process you need to follow to successfully install the BenQ LCD Monitor driver software. These circumstances relate to which version of Microsoft Windows you are using, and whether you are connecting the monitor and installing the software onto a new computer (without existing monitor driver software), or whether you are upgrading an existing installation (which already has existing monitor driver software) with a newer monitor.

In either case however, the very next time you turn on your computer (after connecting the monitor to your computer), Windows will automatically recognize the new (or different) hardware, and will launch its **Found New Hardware wizard**.

Follow the wizard instructions until it asks you to select a monitor model. At that point, click the **Have Disk** button, insert the BenQ LCD Monitor CD-ROM and select the appropriate monitor model. Further details and step-by-step instructions for either an automatic (new) or upgrade (existing) installation, see:

- [How to install the monitor on a new computer on page 23.](#)
- [How to upgrade the monitor on an existing computer on page 24.](#)



- If you require a User Name and Password to login to your Windows computer, you must be logged on as an Administrator or as a member of the Administrators group in order to install the monitor driver software. Furthermore, if your computer is connected to a network which has security access requirements, network policy settings may prevent you from installing software on your computer.
  - To check the name of the purchased model, refer to the specification label on the back of the monitor.
-

## How to install the monitor on a new computer

This instruction details the procedure for selecting and installing the BenQ LCD Monitor driver software on a new computer which has never had a monitor driver installed before. This instruction is only suitable for a computer which has never been used before, and for which the BenQ LCD Monitor is the first ever monitor to be connected to it.



If you are adding the BenQ LCD Monitor to an existing computer that has already had another monitor connected to it (and has monitor driver software installed), you should not be following these instructions. You should instead be following the instructions for [How to upgrade the monitor on an existing computer](#).

1. Follow the instructions in [How to assemble your monitor hardware on page 10](#).  
When Windows starts, it will automatically detect the new monitor and launch the **Found New Hardware Wizard**. Follow the prompts until it displays the option to **Install Hardware Device Drivers**.
2. Insert the BenQ LCD Monitor CD-ROM into a CD drive on the computer.
3. Check **Search for a suitable driver for my device** option, and click **Next**.
4. Check the option for CD-ROM drives (uncheck all others) and click **Next**.
5. Look to confirm that the wizard has selected the correct name of your monitor and click **Next**.
6. Click **Finish**.
7. Restart the computer.



To find the suitable driver files for the purchased model, refer to the following table.

Driver files	Suitable models
BL2420	BL2420PT / BL2420PH / BL2420PE

## How to upgrade the monitor on an existing computer

This instruction details the procedure for manually updating the existing monitor driver software on your Microsoft Windows computer. It is currently tested as compatible for Windows 8.1, Windows 8, and Windows 7 Operating System (OS).



The BenQ LCD Monitor driver for your model may well function perfectly with other versions of Windows, however, as at the time of writing, BenQ has done no testing of this driver on other versions of Windows and cannot guarantee its operation on those systems.

---

Installing monitor driver software involves selecting an appropriate information file (.inf) on the BenQ LCD Monitor CD-ROM for the particular model monitor you have connected, and letting Windows install the corresponding driver files from the CD. You need only steer it in the right direction. Windows has an Upgrade Device Driver Wizard to automate the task and guide you through the file selection and installation process.

See:

- [How to install on Windows 8 \(8.1\) system on page 25.](#)
- [How to install on Windows 7 system on page 26.](#)

## How to install on Windows 8 (8.1) system

### 1. Open **Display Properties**.

Move the cursor to the lower-right of the screen or press the **Windows + C** buttons on the keyboard to bring up the **Charm** bar. Go to **Settings, Control Panel, Devices and Printers** and right-click the name of your monitor from the menu.

Alternatively, right-click the desktop and select **Personalize, Display, Devices and Printers**, and right-click the name of your monitor from the menu.

### 2. Select **Properties** from the menu.

### 3. Click the **Hardware** tab.

### 4. Click **Generic PnP Monitor**, and then the **Properties** button.

### 5. Click the **Driver** tab and the **Update Driver** button.

### 6. Insert the BenQ LCD Monitor CD-ROM into a CD drive on the computer.

### 7. In the **Update Driver Software** window, select the option **Browse my computer for driver software**.

### 8. Click **Browse** and navigate to the following directory: d:\BenQ\_LCD\Driver\ (where d is the drive letter designator for the CD-ROM drive).



The drive letter for your CD drive may differ from the example above depending upon your system - it may be 'D:' or 'E:' or 'F:' etc.

---

### 9. Select the correct folder name of your monitor from provided driver list, and click **Next**.

This will copy and install the appropriate monitor driver files to your computer.

### 10. Click **Close**.

You may be prompted to restart your computer after the driver update is complete.



## How to install on Windows 7 system

### 1. Open **Display Properties**.

Go to **Start, Control Panel, Hardware and Sound, Devices and Printers** and right-click the name of your monitor from the menu.

Alternatively, right-click the desktop and select **Personalize, Display, Devices and Printers**, and right-click the name of your monitor from the menu.

### 2. Select **Properties** from the menu.

### 3. Click the **Hardware** tab.

### 4. Click **Generic PnP Monitor**, and then the **Properties** button.

### 5. Click the **Driver** tab and the **Update Driver** button.

### 6. Insert the BenQ LCD Monitor CD-ROM into a CD drive on the computer.

### 7. In the **Update Driver Software** window, select the option **Browse my computer for driver software**.

### 8. Click **Browse** and navigate to the following directory: d:\BenQ\_LCD\Driver\ (where d is the drive letter designator for the CD-ROM drive).



The drive letter for your CD drive may differ from the example above depending upon your system - it may be 'D:' or 'E:' or 'F:' etc.

---

### 9. Select the correct folder name of your monitor from provided driver list, and click **Next**.

This will copy and install the appropriate monitor driver files to your computer.

### 10. Click **Close**.

You may be prompted to restart your computer after the driver update is complete.

# How to adjust your monitor

## The control panel

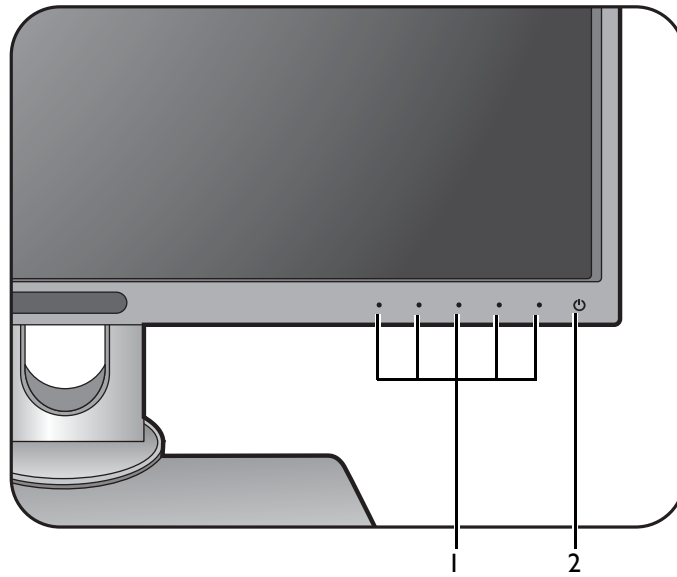

No.	Name	Description
1.	Control keys	Accesses the functions or menu items displayed on the screen, right next to each key.
2.	Power key	Turns the power on or off.



The control keys are embedded in a touchpad and are indicated by the LED indicators. Touch of an LED indicator represents pressing the corresponding control key.

## Basic menu operation

All OSD (On Screen Display) menus can be accessed by the control keys. You can use the OSD menu to adjust all the settings on your monitor.

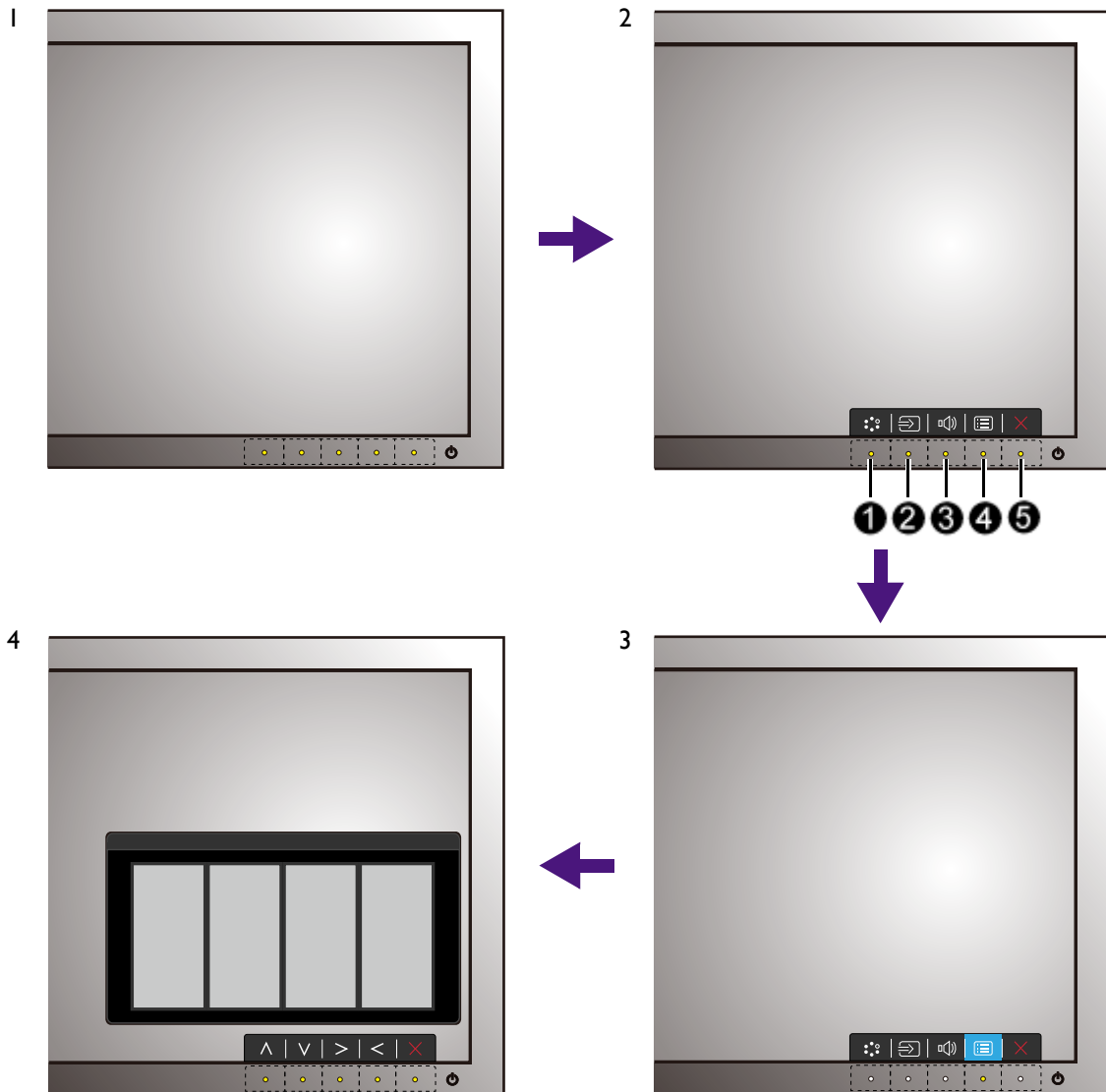

1. Press any of the control keys.
2. The hot key menu is displayed. The left three controls are custom keys and are designated for particular functions.
3. Select  (**Menu**) to access the main menu.
4. In the main menu, follow the icons next to the control keys to make adjustments or selection. See [Navigating the main menu on page 32](#) for details on the menu options.

No.	OSD in hot key menu	OSD icon in main menu	Function
①	<b>Custom Key 1</b>	^	<ul style="list-style-type: none"> <li>• By default, the key is the hot key for <b>Picture Mode</b>. To change the default settings, see <a href="#">Customizing the hot keys on page 30</a>.</li> <li>• For Up/Increase adjustment.</li> </ul>

No.	OSD in hot key menu	OSD icon in main menu	Function
②	Custom Key 2	∨	<ul style="list-style-type: none"> <li>• By default, the key is the hot key for <b>Input</b>. To change the default settings, see <a href="#">Customizing the hot keys on page 30</a>.</li> <li>• For Down/Decrease adjustment.</li> </ul>
③	Custom Key 3	> / ✓	<ul style="list-style-type: none"> <li>• By default, the key is the hot key for <b>Volume</b>. To change the default settings, see <a href="#">Customizing the hot keys on page 30</a>.</li> <li>• Enters sub menus.</li> <li>• Selects menu items.</li> </ul>
④	Menu	<	<ul style="list-style-type: none"> <li>• Activates the main menu.</li> <li>• Returns to the previous menu.</li> </ul>
⑤	Exit	×	Exits OSD menu.



- OSD = On Screen Display.  
The hot keys only operate while the main menu is not currently displaying. Hot key displays will disappear after a few seconds of no key activity.
- To unlock the OSD controls, press and hold any key for 10 seconds.

## Controlling the display with Display Pilot

The **Display Pilot** software is provided as an alternative to control the display. Download and install from [www.benq.com](http://www.benq.com).

The main functions include:

- Control of the OSD menus.
- Setup of rotating the display with the monitor automatically (see [page 19](#)).

For more information, go to **System > Options > User Manual** in **Display Pilot**.



**Display Pilot** is available on Windows operating systems only.

## Picture optimization

The easiest way to obtain an optimal display from an analog (D-Sub) input is to use the **Auto Adjustment** function. Go to **Display** and **Auto Adjustment** to optimize the currently displayed image to the screen.



When you connect a digital input signal using a digital (DVI, HDMI, or DP) cable to your monitor, the **Auto Adjustment** function will be disabled, because the monitor will automatically display the best image.



Please ensure that the connected graphic card on your computer is set to the native resolution of the monitor when you use the **Auto Adjustment** function.

---

If you wish, you can always adjust the screen geometric settings manually using geometry menu items. To assist you in this endeavour, BenQ has provided a screen test image utility which you can use to check for screen color, grayscale and line gradient display.

1. Run the test program auto.exe from CD-ROM. You could also use any other image, such as the desktop of your operating system. However, we recommend that you use auto.exe. As you run auto.exe, a test pattern displays.
2. Press any of the control keys to bring up the hot key menu. Select  (**Menu**) to access the main menu.
3. Go to **Display** and **Auto Adjustment**.
4. If you notice a vertical noise (like a curtain effect-shimmering of vertical lines), select **Pixel Clock** and adjust the monitor until the noise disappears.
5. If you notice a horizontal noise, select **Phase** and adjust the monitor until the noise disappears.

## Customizing the hot keys

The left 3 control keys (also called custom keys) perform as hot keys to provide direct access to pre-defined functions. You can change the default setting and designate different functions for these keys.

1. Press any of the control keys to bring up the hot key menu, and press  (**Menu**) to access the main menu.
2. Go to **System**.
3. Select the custom key you want to change.
4. In the sub menu, select a function that can be accessed by this key. A pop-up message will appear, showing that the setup is complete.

## Adjusting display mode

To display images of aspect ratio other than 16:9 and size other than the panel size of your purchased model, you can adjust the display mode on the monitor.

1. Press any of the control keys to bring up the hot key menu, and press  (**Menu**) to access the main menu.
2. Go to **Picture Advanced** and **Display Mode**.
3. Select an appropriate display mode. The setting will take effect immediately.

## Choosing an appropriate picture mode

Your monitor provides various picture modes that are suitable for different types of images. See [Picture Mode on page 37](#) for all the available picture modes.

Go to **Picture Advanced** and **Picture Mode** for a desired picture mode.

## Connecting the monitor to your MacBook series product

While the monitor is connected to your MacBook series product, switch to **M-book** mode which represents MacBook's color matching and visual representation on your monitor.

1. Connect your monitor to the MacBook series product.
2. Go to **Picture Advanced** and **Picture Mode**.
3. Select **M-book**. The setting will take effect immediately.

# Navigating the main menu

You can use the OSD (On Screen Display) menu to adjust all the settings on your monitor.

Press any of the control keys to bring up the hot key menu, and press  (**Menu**) to access the main menu. See [Basic menu operation on page 28](#) for details.

Available menu options may vary depending on the input sources, functions and settings. Menu options that are not available will become grayed out. And keys that are not available will be disabled and the corresponding OSD icons will disappear. For models without certain functions, their settings and related items will not appear on the menu.



The OSD menu languages may differ from the product supplied to your region, see [Language on page 42](#) under **System** and **OSD Settings** for more details.

---

For more information on each menu, please refer to the following pages:









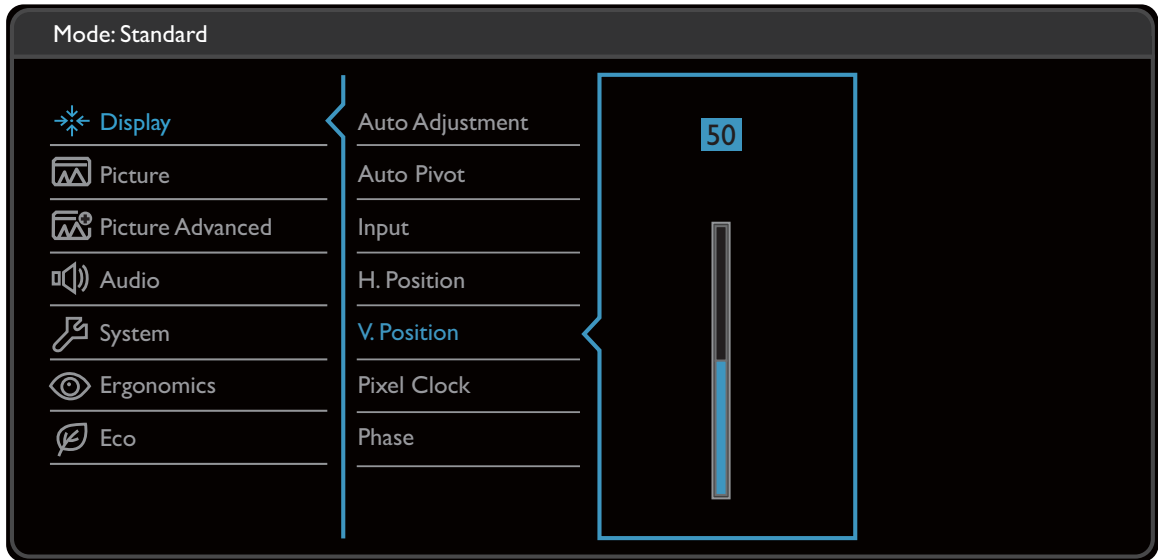

- [Display menu on page 33](#)
- [Picture menu on page 35](#)
- [Picture Advanced menu on page 37](#)
- [Audio menu on page 40](#)
- [Ergonomics menu on page 45](#)
- [Eco menu on page 47](#)
- [System menu on page 41](#)





## Display menu

Available menu options may vary depending on the input sources, functions and settings. Menu options that are not available will become grayed out. And keys that are not available will be disabled and the corresponding OSD icons will disappear. For models without certain functions, their settings and related items will not appear on the menu.



1. Select  (**Menu**) from the hot key menu.
2. Use  or  to select **Display**.
3. Select  to go to a sub menu, and then use  or  to select a menu item.
4. Use  or  to make adjustments, or use  to make selection.
5. To return to the previous menu, select .
6. To exit the menu, select .









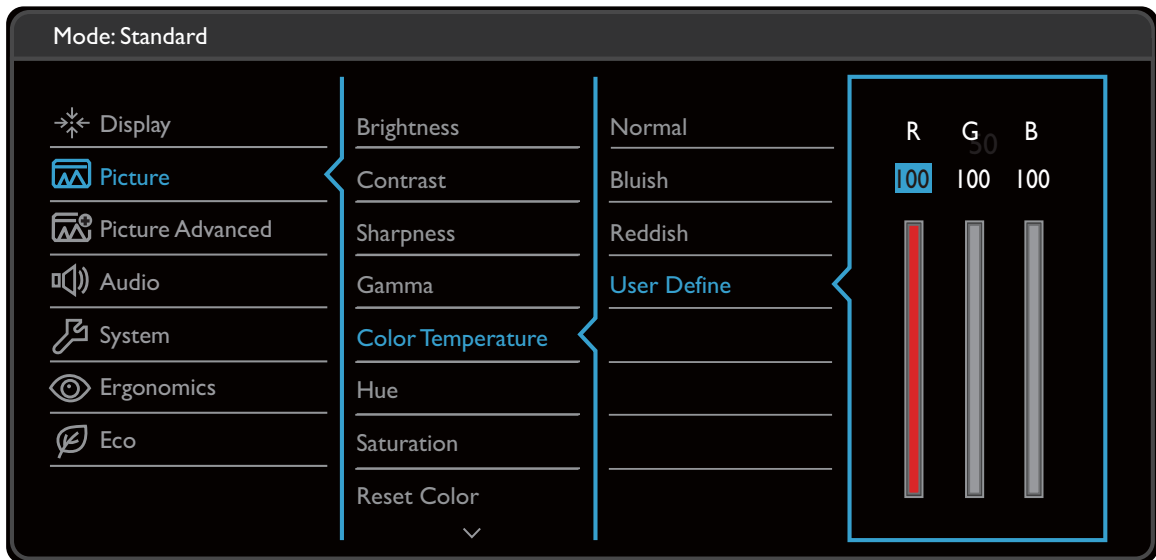

Item	Function	Range
<b>Auto Adjustment</b>	Optimizes and adjusts the screen settings automatically for you.  Not applicable to a digital input signal.	
<b>Auto Pivot</b>	Sets to rotate the display with the monitor.	
<b>Input</b>	Use this to change the input to that appropriate to your video cable connection type.	<ul style="list-style-type: none"> <li>• D-Sub</li> <li>• DVI</li> <li>• HDMI</li> <li>• DisplayPort</li> </ul>

Item	Function	Range
<b>H. Position</b>	Adjusts the horizontal position of the screen image.	0 to 100
<b>V. Position</b>	Adjusts the vertical position of the screen image.	0 to 100
<b>Pixel Clock</b>	<p>Adjusts the pixel clock frequency timing to synchronize with the analog input video signal. See also: <a href="#">Picture optimization on page 30.</a></p> <p> Not applicable to a digital input signal.</p>	0 to 100
<b>Phase</b>	<p>Adjusts the pixel clock phase timing to synchronize with the analog input video signal. See also: <a href="#">Picture optimization on page 30.</a></p> <p> Not applicable to a digital input signal.</p>	0 to 63

## Picture menu

Available menu options may vary depending on the input sources, functions and settings. Menu options that are not available will become grayed out. And keys that are not available will be disabled and the corresponding OSD icons will disappear. For models without certain functions, their settings and related items will not appear on the menu.



1. Select  (**Menu**) from the hot key menu.
2. Use  or  to select **Picture**.
3. Select  to go to a sub menu, and then use  or  to select a menu item.
4. Use  or  to make adjustments, or use  to make selection.
5. To return to the previous menu, select .
6. To exit the menu, select .









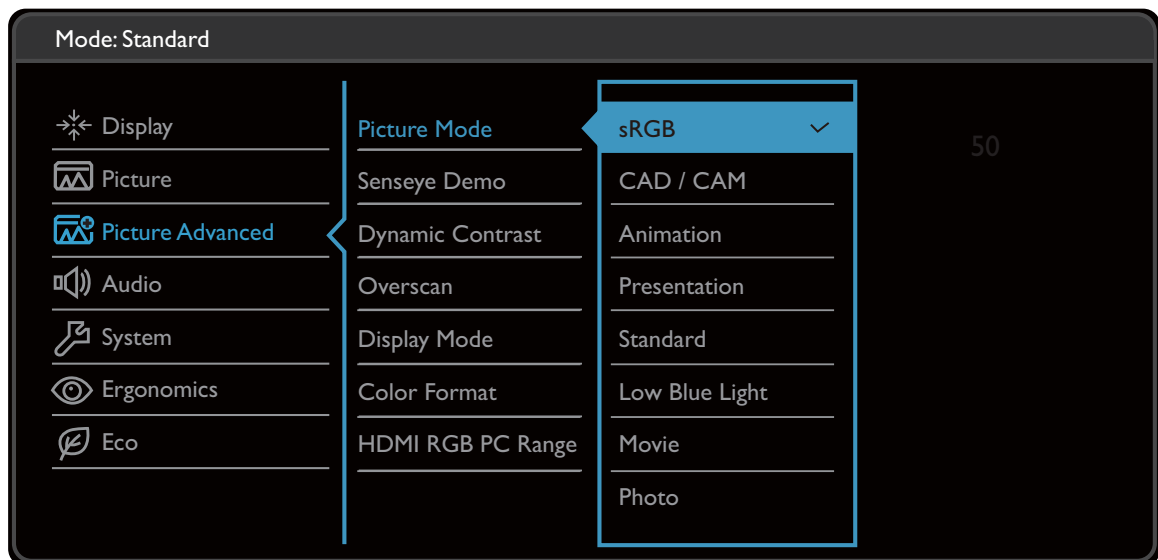

Item	Function	Range
<b>Brightness</b>	Adjusts the balance between light and dark shades.	0 to 100
<b>Contrast</b>	Adjusts the degree of difference between darkness and lightness.	0 to 100
<b>Sharpness</b>	Adjusts the clarity and visibility of the edges of the subjects in the image.	1 to 10

Item	Function		Range
<b>Gamma</b>	Adjusts the tone luminance. The default value is 3 (the standard value for Windows).		<ul style="list-style-type: none"> <li>• 1</li> <li>• 2</li> <li>• 3</li> <li>• 4</li> <li>• 5</li> </ul>
<b>Color Temperature</b>	<b>Normal</b>	Allows video and still photographs to be viewed with natural coloring. This is the factory default color.	
	<b>Bluish</b>	Applies a cool tint to the image and is factory pre-set to the PC industry standard white color.	
	<b>Reddish</b>	Applies a warm tint to the image and is factory pre-set to the news print standard white color.	
	<b>User Define</b>	<p>The blend of the Red, Green and Blue primary colors can be altered to change the color tint of the image. Go to the succeeding <b>R</b> (red), <b>G</b> (green), and <b>B</b> (blue) menus to change the settings.</p> <p>Decreasing one or more of the colors will reduce their respective influence on the color tint of the image. (e.g. if you reduce the Blue level the image will gradually take on a yellowish tint. If you reduce Green, the image will become a magenta tint.)</p>	<ul style="list-style-type: none"> <li>• R (0~100)</li> <li>• G (0~100)</li> <li>• B (0~100)</li> </ul>
<b>Hue</b>	Adjusts the degree of how we perceive colors.		0 ~ 100
<b>Saturation</b>	Adjusts the purity degree of colors.		0 ~ 100
<b>Reset Color</b>	Resets the custom color settings to the factory defaults.		<ul style="list-style-type: none"> <li>• YES</li> <li>• NO</li> </ul>
<b>AMA</b>	Improves the gray level response time of the LCD panel.		<ul style="list-style-type: none"> <li>• OFF</li> <li>• High</li> <li>• Premium</li> </ul>



## Picture Advanced menu





Available menu options may vary depending on the input sources, functions and settings. Menu options that are not available will become grayed out. And keys that are not available will be disabled and the corresponding OSD icons will disappear. For models without certain functions, their settings and related items will not appear on the menu.



1. Select  (**Menu**) from the hot key menu.
2. Use  or  to select **Picture Advanced**.
3. Select  to go to a sub menu, and then use  or  to select a menu item.
4. Use  or  to make adjustments, or use  to make selection.
5. To return to the previous menu, select .
6. To exit the menu, select .

Item	Function		Range
<b>Picture Mode</b>	Select a picture mode that best suits the type of images shown on the screen.		
	<b>sRGB</b>	For better color matching representation with the peripheral devices, such as printers, digital cameras, etc.	
	<b>CAD / CAM</b>	Enhances the contrast if a CAD / CAM software is used.	
	<b>Animation</b>	Enhances the contrast of the dark shades so you could work on the details easily when making an animation.	0 ~ 10









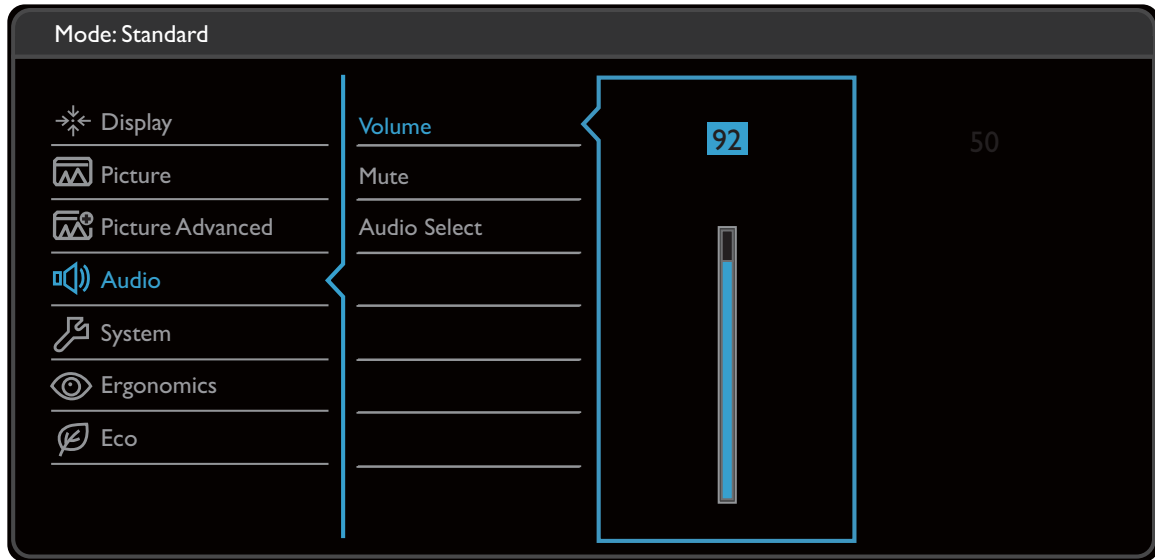

Item	Function		Range	
	<b>Presentation</b>	Minimizes the differences of color, contrast, and brightness between the images displayed on the monitor and projected by a projector.		
	<b>Standard</b>	For basic PC application.		
	<b>Low Blue Light</b>	Decreases the blue light emitted from the display to reduce the risk of blue light exposure to your eyes.		
		 The value for each <b>Low Blue Light</b> mode indicates how much blue light is decreased compared with the <b>Standard</b> mode.		
		<b>Multimedia</b>	For viewing multimedia files.	-30%
		<b>Web Surfing</b>	For web surfing.	-50%
		<b>Office</b>	For office works or office environment.	-60%
	<b>Reading</b>	For reading e-books or documents.	-70%	
	<b>Movie</b>	For viewing videos.		
	<b>Photo</b>	For viewing still images.		
<b>Eco</b>	For saving electricity with low power consumption by providing minimum brightness for all running programs.			
<b>M-book</b>	Minimizes the visual differences between the monitor and the connected MacBook series product.			
<b>User</b>	Applies a combination of picture settings defined by users.			
<b>Senseye Demo</b>	Displays the preview of screen images under the selected mode from Picture Mode. The screen will be divided into two windows; the left window demonstrates images of Standard mode, while the right window presents the images under the specified mode.		<ul style="list-style-type: none"> <li>• ON</li> <li>• OFF</li> </ul>	
<b>Dynamic Contrast</b>	The function is to automatically detect the distribution of an input visual signal, and then to create the optimal contrast.		0 to 5	
<b>Overscan</b>	Slightly enlarges the input image. Use this feature to hide annoying edge noise if present around your image.		<ul style="list-style-type: none"> <li>• ON</li> <li>• OFF</li> </ul>	
	 Available only when the input source is HDMI, DP, or D-Sub (VGA converted from Component).			

Item	Function		Range
<b>Display Mode</b>	<p>This feature is provided to allow aspect ratios other than 16:9 to be displayed without geometric distortion.</p> <p> The options under <b>Display Mode</b> will be different depending on the input signal sources.</p> <p> Depending on your selection of <b>Picture Mode</b>, different <b>Display Mode</b> option is pre-set. Change the setting if needed.</p>		
	<b>Full</b>	Scales the input image to fill the screen. Ideal for 16:9 aspect images.	
	<b>Aspect</b>	The input image is displayed without geometric distortion filling as much of the display as possible.	
	<b>1:1</b>	Displays the input image in its native resolution without scaling.	
<b>Color Format</b>	<p>Determines the color space (<b>RGB</b> or <b>YUV</b>) based on the detected video signal.</p> <p> You might need to manually set the <b>Color Format</b> if colors shown on the monitor screen do not display properly.</p> <p> If the input source is HDMI or DP, color format is not selectable. In other words, <b>Color Format</b> is automatically set depending on the input video source.</p>		
	<b>RGB</b>	<ul style="list-style-type: none"> <li>• For D-Sub (VGA) input source from PC.</li> <li>• For DVI input source.</li> </ul>	
	<b>YUV</b>	For D-Sub (Component converted from VGA) input source from a video device.	
<b>HDMI RGB PC Range</b>	Determines the range of color scales. Select an option that matches the RGB range setting on the connected HDMI device.		<ul style="list-style-type: none"> <li>• <b>RGB</b> (0 ~ 255)</li> <li>• <b>RGB</b> (16 ~ 235)</li> </ul>

## Audio menu

Available menu options may vary depending on the input sources, functions and settings. Menu options that are not available will become grayed out. And keys that are not available will be disabled and the corresponding OSD icons will disappear. For models without certain functions, their settings and related items will not appear on the menu.



1. Select  (**Menu**) from the hot key menu.
2. Use  or  to select **Audio**.
3. Select  to go to a sub menu, and then use  or  to select a menu item.
4. Use  or  to make adjustments, or use  to make selection.
5. To return to the previous menu, select .
6. To exit the menu, select .









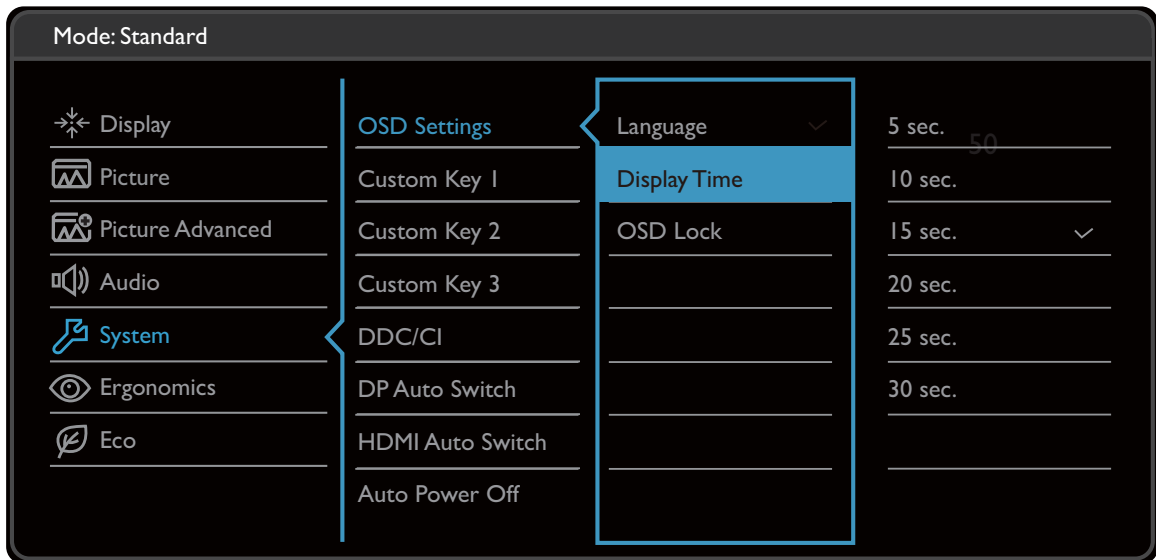

Item	Function	Range
<b>Volume</b>	Adjusts the audio volume.	0 ~ 100
<b>Mute</b>	Mutes the audio input.	<ul style="list-style-type: none"> <li>• ON</li> <li>• OFF</li> </ul>
<b>Audio Select</b> (for models with more than 2 audio sources)	Allow users to select the audio source or let the monitor detect it automatically.	<ul style="list-style-type: none"> <li>• PC Audio</li> <li>• Auto Detect</li> </ul>





## System menu

Available menu options may vary depending on the input sources, functions and settings. Menu options that are not available will become grayed out. And keys that are not available will be disabled and the corresponding OSD icons will disappear. For models without certain functions, their settings and related items will not appear on the menu.



1. Select  (**Menu**) from the hot key menu.
2. Use  or  to select **System**.
3. Select  to go to a sub menu, and then use  or  to select a menu item.
4. Use  or  to make adjustments, or use  to make selection.
5. To return to the previous menu, select .
6. To exit the menu, select .

Item	Function		Range
<b>OSD Settings</b>	<b>Language</b>	Sets the OSD menu language.   The language options displayed on your OSD may differ from those shown on the right, depending on the product supplied in your region.	<ul style="list-style-type: none"> <li>• English</li> <li>• Français</li> <li>• Deutsch</li> <li>• Italiano</li> <li>• Español</li> <li>• Polski</li> <li>• Český</li> <li>• Magyar</li> <li>• SiCG/BIH/CRO</li> <li>• Română</li> <li>• Nederlands</li> <li>• Русский</li> <li>• Svenska</li> <li>• Português</li> <li>• 日本語</li> <li>• 繁體中文</li> <li>• 简体中文</li> </ul>
	<b>Display Time</b>	Adjusts the display time of the OSD menu.	<ul style="list-style-type: none"> <li>• 5 sec.</li> <li>• 10 sec.</li> <li>• 15 sec.</li> <li>• 20 sec.</li> <li>• 25 sec.</li> <li>• 30 sec.</li> </ul>
	<b>OSD Lock</b>	Prevents all the monitor settings from being accidentally changed. When this function is activated, the OSD controls and hotkey operations will be disabled.   To unlock the OSD controls, press and hold any key for 10 seconds.	









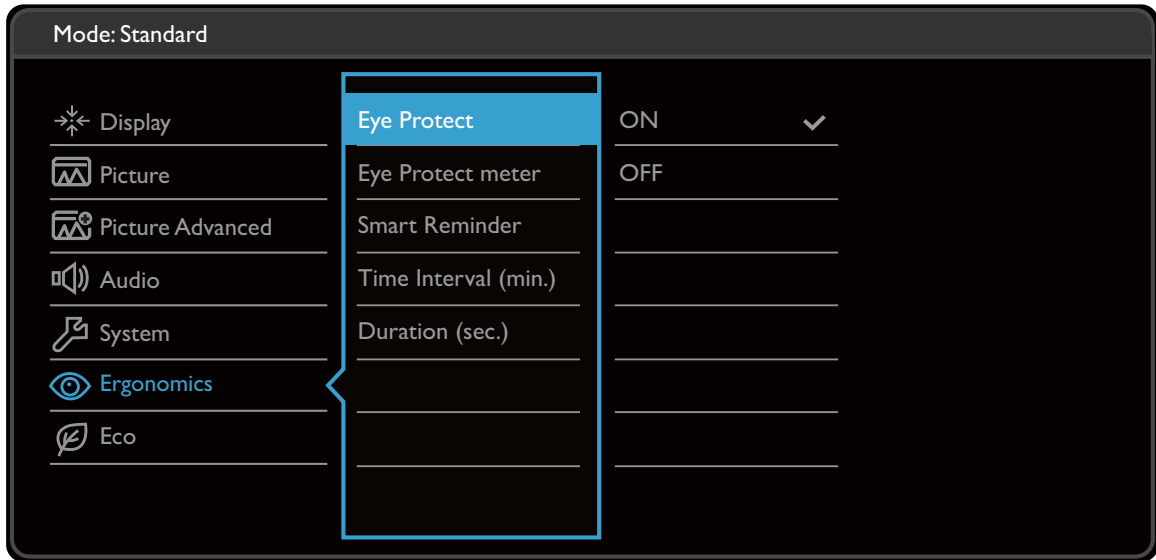

Item	Function	Range
<b>Custom Key 1</b>	Sets the function to be accessed by custom key 1.	<ul style="list-style-type: none"> <li>• <b>Picture Mode</b></li> <li>• <b>CAD / CAM</b></li> <li>• <b>Animation</b></li> <li>• <b>Low Blue Light</b></li> <li>• <b>Display Mode</b></li> <li>• <b>Brightness</b></li> <li>• <b>Contrast</b></li> <li>• <b>Auto Adjustment</b></li> <li>• <b>Volume</b></li> <li>• <b>Mute</b></li> <li>• <b>Input</b></li> <li>• <b>Eye Protect</b></li> <li>• <b>Eye Protect Meter</b></li> <li>• <b>ECO Sensor</b></li> <li>• <b>ECO Sensor Meter</b></li> <li>• <b>Smart Reminder</b></li> </ul>
<b>Custom Key 2</b>	Sets the function to be accessed by custom key 2.	
<b>Custom Key 3</b>	Sets the function to be accessed by custom key 3.	
<b>DDC/CI</b>	<p>Allows the monitor settings to be set through the software on the PC.</p> <p> DDC/CI, short for Display Data Channel/Command Interface, which was developed by Video Electronics Standards Association (VESA). DDC/CI capability allows monitor controls to be sent via the software for remote diagnostics.</p>	<ul style="list-style-type: none"> <li>• <b>ON</b></li> <li>• <b>OFF</b></li> </ul>
<b>DP Auto Switch</b>	When this function is activated, DP port will be in the input auto select loop. Otherwise, DP can only be selected by input select or by hot key.	<ul style="list-style-type: none"> <li>• <b>ON</b></li> <li>• <b>OFF</b></li> </ul>
<b>HDMI Auto Switch</b>	When this function is activated, HDMI port will be in the input auto select loop. Otherwise, HDMI can only be selected by input select or by hot key.	<ul style="list-style-type: none"> <li>• <b>ON</b></li> <li>• <b>OFF</b></li> </ul>
<b>Auto Power Off</b>	Sets the time to power off the monitor automatically in power saving mode.	<ul style="list-style-type: none"> <li>• <b>OFF</b></li> <li>• <b>10min.</b></li> <li>• <b>20min.</b></li> <li>• <b>30min.</b></li> </ul>
<b>Resolution Notice</b>	Sets whether to display the resolution notice of the recommended resolution when a new input source is detected by the monitor.	<ul style="list-style-type: none"> <li>• <b>ON</b></li> <li>• <b>OFF</b></li> </ul>

Item	Function	Range
<b>Information</b>	Displays the current monitor property settings.	<ul style="list-style-type: none"> <li>• <b>Input</b></li> <li>• <b>Current Resolution</b></li> <li>• <b>Optimum Resolution</b> (best with the monitor)</li> </ul>
<b>DisplayPort</b>	Selects an appropriate DP standard for data transmission.	<ul style="list-style-type: none"> <li>• <b>1.1</b></li> <li>• <b>1.2</b></li> </ul>
<b>Reset All</b>	Resets all mode, color and geometry settings to the factory default values.	<ul style="list-style-type: none"> <li>• <b>YES</b></li> <li>• <b>NO</b></li> </ul>

## Ergonomics menu

Available menu options may vary depending on the input sources, functions and settings. Menu options that are not available will become grayed out. And keys that are not available will be disabled and the corresponding OSD icons will disappear. For models without certain functions, their settings and related items will not appear on the menu.



1. Select  (**Menu**) from the hot key menu.
2. Use  or  to select **Ergonomics**.
3. Select  to go to a sub menu, and then use  or  to select a menu item.
4. Use  or  to make adjustments, or use  to make selection.
5. To return to the previous menu, select .
6. To exit the menu, select .

Item	Function	Range
<b>Eye Protect</b>	<p>Your monitor comes with a light sensor, which detects the light condition around the monitor and adjusts the monitor backlight automatically. This is to protect your eyes from overexposure to bright light.</p> <p>If the light is sufficient, the monitor brightness is increased. If the monitor is in a poor light, the monitor brightness is decreased.</p> <p> If you prefer to adjust the monitor brightness manually, go to <b>PICTURE &gt; Brightness</b>.</p>	<ul style="list-style-type: none"> <li>• <b>ON</b></li> <li>• <b>OFF</b></li> </ul>

Item	Function	Range
<b>Eye Protect Meter</b>	Sets to display the light condition around the monitor on the screen.	<ul style="list-style-type: none"> <li>• ON</li> <li>• OFF</li> </ul>
<b>Smart Reminder</b>	Decides to display the pop-up message that reminds you to rest your eyes.	<ul style="list-style-type: none"> <li>• ON</li> <li>• OFF</li> </ul>
<b>Time interval (min.)</b>	Sets the interval of the reminder message.	<ul style="list-style-type: none"> <li>• 20</li> <li>• 40</li> <li>• 60</li> <li>• 80</li> <li>• 100</li> </ul>
<b>Duration (sec.)</b>	<p>Sets the time the reminder message lasts on the screen.</p>  Alternatively, when the reminder message is displayed, press any key except the power button to hide the message.	<ul style="list-style-type: none"> <li>• 5</li> <li>• 10</li> <li>• 15</li> <li>• 20</li> <li>• 25</li> </ul>

## Eco menu

Available menu options may vary depending on the input sources, functions and settings. Menu options that are not available will become grayed out. And keys that are not available will be disabled and the corresponding OSD icons will disappear. For models without certain functions, their settings and related items will not appear on the menu.

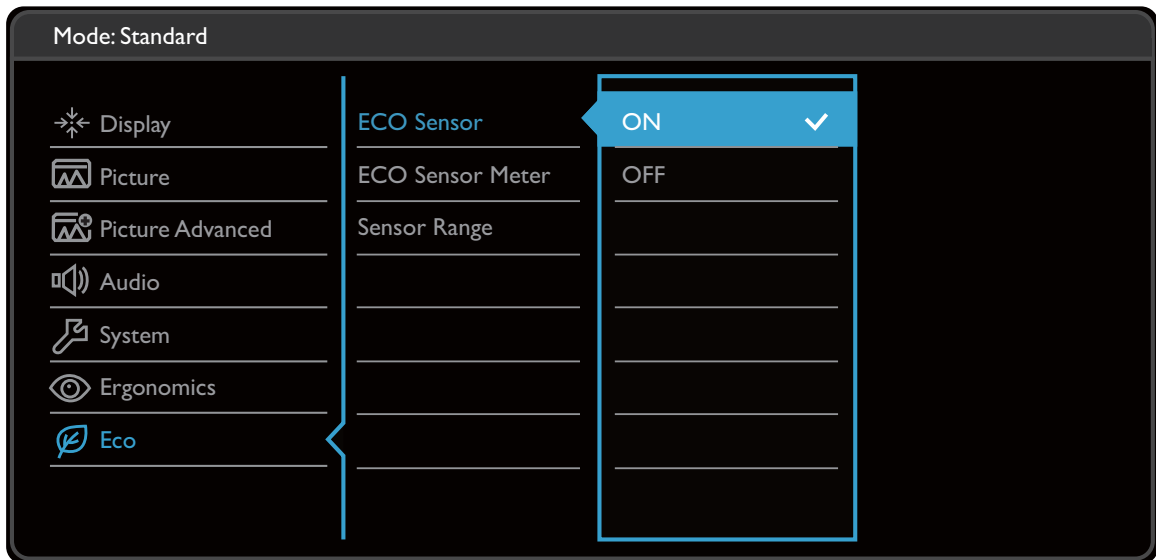

1. Select  (**Menu**) from the hot key menu.
2. Use  $\wedge$  or  $\vee$  to select **Eco**.
3. Select  $\>$  to go to a sub menu, and then use  $\wedge$  or  $\vee$  to select a menu item.
4. Use  $\wedge$  or  $\vee$  to make adjustments, or use  $\checkmark$  to make selection.
5. To return to the previous menu, select  $\leftarrow$ .
6. To exit the menu, select  $\times$ .













Item	Function	Range
<b>ECO Sensor</b>	<p>Your monitor comes with a proximity sensor (called ECO sensor), which detects your presence in front of the monitor within the set range. If the sensor detects no presence, the monitor is turned off in 40 seconds to save power.</p> <p> If the monitor is turned off by the ECO sensor, the power button flashes in green. If the ECO sensor detect no presence for over 2 hours, the monitor will be powered off. Press the power button to turn on the monitor.</p>	<ul style="list-style-type: none"> <li>• <b>ON</b></li> <li>• <b>OFF</b></li> </ul>





















Item	Function	Range
<b>ECO Sensor Meter</b>	Sets to display the countdown to turn off the monitor.	<ul style="list-style-type: none"> <li>• <b>ON</b></li> <li>• <b>OFF</b></li> </ul>
<b>Sensor Range</b>	Decides how far the sensor can detect.	<ul style="list-style-type: none"> <li>• <b>Near</b></li> <li>• <b>Middle</b></li> <li>• <b>Far</b></li> </ul>



# Troubleshooting

## Frequently asked questions (FAQ)

-  The image is blurred.
-  Read the instructions on the link "**Adjusting the Screen Resolution**" on the CD, and then select the correct resolution, refresh rate and make adjustments based on these instructions.
-  How do you use a VGA extension cable?
-  Remove the extension cable for the test. Is the image now in focus? If not, optimize the image by working through the instructions in the "**Adjusting the refresh rate**" section on the link "**Adjusting the Screen Resolution**". It is normal for blurring to occur due to conduction losses in extension cables. You can minimize these losses by using an extension cable with better conduction quality or with a built-in booster.
-  Does the blurring only occur at resolutions lower than the native (maximum) resolution?
-  Read the instructions on the link "**Adjusting the Screen Resolution**" on the CD. Select the native resolution.
-  Pixel errors can be seen.
- One of several pixels is permanently black, one or more pixels are permanently white, one or more pixels are permanently red, green, blue or another color.
-  • Clean the LCD screen.
- Cycle power on-off.
- These are pixels that are permanently on or off and is a natural defect that occurs in LCD technology.
-  The image has a faulty coloration.
-  It has a yellow, blue or pink appearance.
- Go to **Picture** and **Reset Color**, and then choose **YES** to reset the color settings to the factory defaults.
- If the image is still not correct and the OSD also has faulty coloration, this means one of the three primary colors is missing in the signal input. Now check the signal cable connectors. If any pin is bent or broken off, please contact your dealer to get necessary support.
-  No image can be seen.
-  Is the prompt on the display illuminated in green?
- If the LED is illuminated in green and there is a message **Out of Range** on the screen, this means you are using a display mode that this monitor does not support, please change the setting to one of the supported mode. Please read the "**Preset display modes**" section from the link "**Adjusting the Screen Resolution**".

-  Faint shadow from the static image displayed is visible on the screen.
-  • Activate the power management function to let your computer and monitor go into a low power "sleep" mode when not actively in use.
-  • Use a screensaver to prevent the occurrence of image retention.
-  Is the prompt on the display illuminated in orange?
-  If the LED is illuminated in orange, the power management mode is active. Press any button on the computer keyboard or move the mouse. If that does not help, check the signal cable connectors. If any pin is bent or broken off, please contact your dealer to get necessary support.
-  Is the prompt on the display not illuminated at all?
-  Check the power supply mains socket, the external power supply and the mains switch.
-  The image is distorted, flashes or flickers.
-  Read the instructions on the link "**Adjusting the Screen Resolution**" on the CD, and then select the correct resolution, refresh rate and make adjustments based on these instructions.
-  You are running the monitor at its native resolution, but the image is still distorted.
-  Images from different input sources may appear distorted or stretched on the monitor running at its native resolution. To have the optimal display performance of each type of input sources, you can use the **Display Mode** function to set a proper aspect ratio for the input sources. See [Display Mode on page 39](#) for details.
-  The image is displaced in one direction.
-  Read the instructions on the link "**Adjusting the Screen Resolution**" on the CD, and then select the correct resolution, refresh rate and make adjustments based on these instructions.
-  The OSD controls are inaccessible.
-  To unlock the OSD controls when it is preset to be locked, press and hold any key for 10 seconds.
-  No sound can be heard from the connected external speakers.
-  • Remove your headphone (if the headphone is connected to the monitor).
-  • Check whether the headphone jack is properly connected.
-  • If the external speakers are USB-powered, check whether the USB connection is OK.
-  • Increase the volume (volume may be muted or too low) on the external speakers.

? No sound can be heard from the built-in speakers:

- ✓ • Check whether Line In is properly connected.
- Increase the volume (volume may be muted or too low).
- Remove your headphone and/or external speakers. (If they are connected to the monitor, the built-in speakers are automatically muted.)

? The light sensor of the monitor does not work well.

✓ The light sensor is located at the front bottom of the monitor. Please check:

- If the Eye Protect function is set to **ON**. Check **Ergonomics > Eye Protect**.
- If there are any obstacles in front of the sensor that keep the sensor from detecting the light properly.
- If there are any objects or clothing in bright colors in front of the sensor. Bright colors (especially white and fluorescent colors) reflect light and the sensor cannot detect the main light sources.

? The ECO sensor of the monitor does not work well.

- ✓ • The ECO sensor is located at the front bottom of the monitor. Check if there are any obstacles in front of the sensor that keep the sensor from detecting your presence properly.
- The colors and the materials of your clothes may affect the detection. Adjust the sensor range if needed. See [Sensor Range on page 48](#) for more information.
- Adjust the distance between you and the monitor.

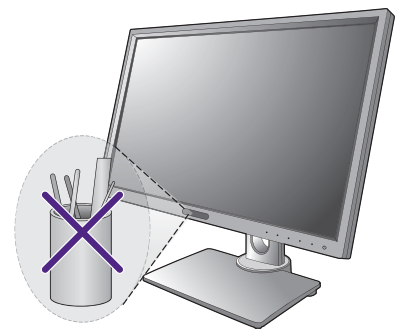

If none of the proceeding actions works, it is probably because the materials of your clothes are unique and cannot be detected by the ECO sensor. Please be noted that this is neither a manufacturing defect nor is the sensor damaged. You should turn off the ECO sensor for now in **Eco > ECO Sensor**.

## Need more help?

If your problems remain after checking this manual, please contact your place of purchase or e-mail us at: [Support@BenQ.com](mailto:Support@BenQ.com).