

NA-SYC2

Noctua NA-SYC2 3x 3-Pin Y-Cables

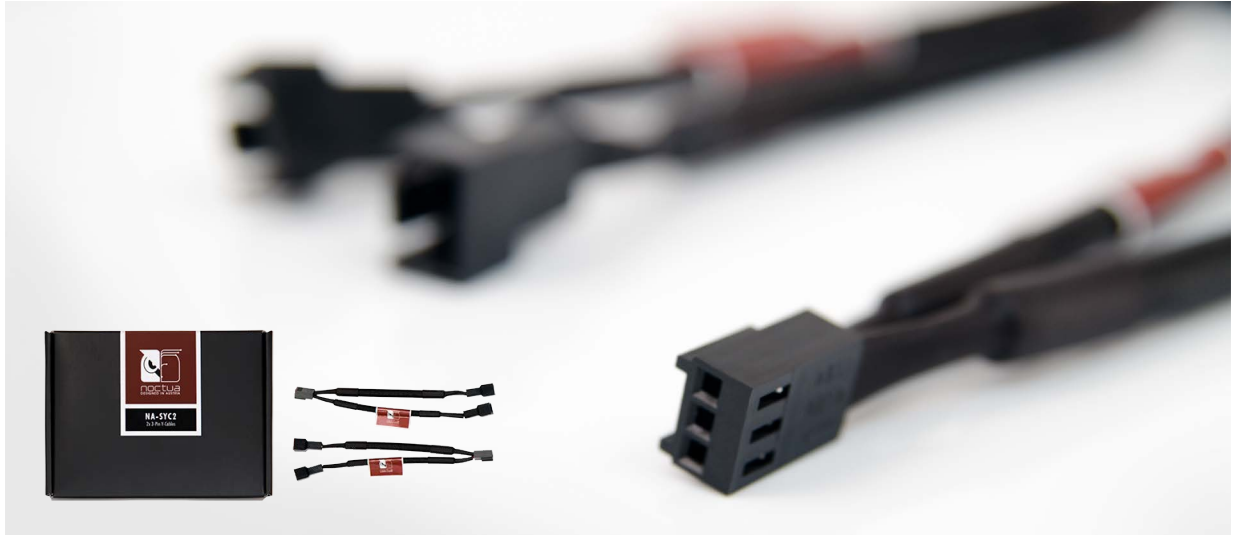

The NA-SYC2 is a fan accessory set consisting of two fully sleeved NA-YC2 Y-Cables for 3-pin fans. The NA-YC2 Y-Cables make it possible to run two 3-pin fans on a single fan header.

LOGISTICAL DATAS

Product Labeling

Noctua NA-SYC2

EAN-No.

4716123315209

UPC-No.

842431013316

Dimensions (HxWxD)

150 x 111 x 29 mm

Weight

58 gr

Warranty

6 Years

MSPR

5.90 EUR

Packaging Unit

40 Pcs.

Dimensions / Unit (HxWxD)

320 x 320 x 240 mm

Weight / Unit

2.96 kg

SCOPE OF DELIVERY

3x NA-SYC2

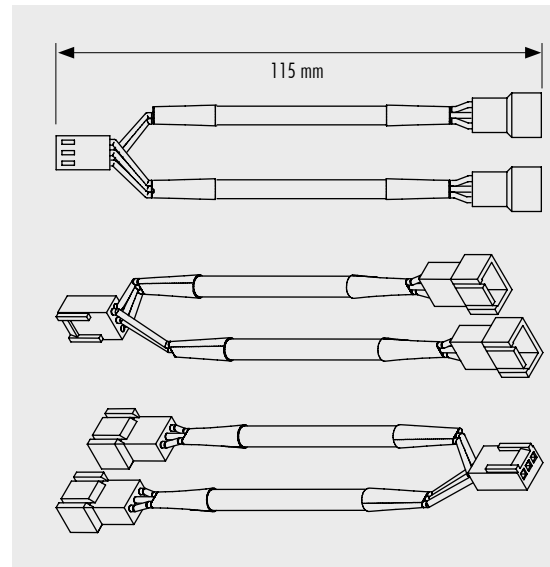

Caution: Common mainboard fan headers support up to 9.6 or 12W (check your mainboard manual for detailed information). Therefore please make sure that the combined power draw of the fans connected to one fan header using NA-YC2 adaptors does not exceed this value!