



Owner's Manual IPS LED MONITOR (LED MONITOR*)

*LG LED Monitors are LCD Monitors with LED Backlighting.

Please read this manual carefully before operating your set and retain it for future reference.

IPS LED MONITOR MODEL

24MP59G

27MP59G

CONTENTS

LICENSE ----- 3

ASSEMBLING AND PREPARING - 4

- Product Components ----- 4
- Supported Drivers and Software ----- 5
- Component and Button Description ----- 6
 - How to Use the Joystick Button
 - Input Connector
- Moving and Lifting the Monitor ----- 8
- Setting up the Monitor set ----- 9
 - Attaching the Stand Base
 - Mounting on a table
 - Using the cable holder

USING THE MONITOR SET----- 12

- Connecting to a PC ----- 12
 - D-SUB connection
 - HDMI connection
 - DisplayPort connection
- Connecting to AV Devices ----- 13
 - HDMI connection
- Connecting Peripherals ----- 14
 - Connecting Headphones

CUSTOMIZING SETTINGS ----- 15

TROUBLESHOOTING ----- 21

SPECIFICATIONS ----- 22

- Preset Modes (Resolution) ----- 24
- Indicator ----- 24

LICENSE

Each model has different licenses. Visit www.lg.com for more information on the license.



The terms HDMI and HDMI High-Definition Multimedia Interface, and the HDMI logo are trademarks or registered trademarks of HDMI Licensing LLC in the United States and other countries.

The following content is only applied to the monitor which is sold in Europe market and which needs to meet the ErP Directive:

* This monitor is set to be turned off automatically in 4 hours after you turned on display if there is no adjustment to display.

* To make this setting be disabled, change the option to 'Off' in OSD menu of "Automatic Standby".

ASSEMBLING AND PREPARING

Product Components

Please check whether all the components are included in the box before using the product. If there are missing components, contact the retail store where you purchased the product. Note that the product and components may look different from those shown here.

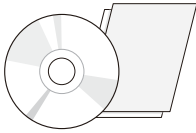

**CD(Owner's Manual) /
Card**

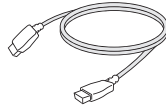

HDMI Cable
(This cable is not included in all
countries.)



D-SUB Cable
(This cable is not included in all
countries.)



Power Cord
(Depending on the country)

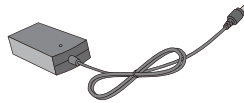

AC-DC Adapter

or



AC-DC Adapter
(Depending on the country)



Display Port Cable
(This cable is not
included in allcountries.)

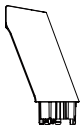

Stand Body

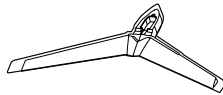

Stand Base



Cable Holder



CAUTION

- Always use genuine components to ensure safety and product performance.
- The product warranty will not cover damage or injury caused by the use of counterfeit components.
- It is recommend that use the supplied components.
- If you use generic cables not certified by LG, the screen may not display or there may be image noises.



NOTE

- Note that the components may look different from those shown here.
- Without prior notice, all information and specifications in this manual are subject to change to improve the performance of the product.
- To purchase optional accessories, visit an electronics store or online shopping site or contact the retail store where you purchased the product.

Supported Drivers and Software

Check the drivers and software supported by your product and refer to the manuals on the CD enclosed in the product package.

Drivers and Software	Installation Priority	24MP59G 27MP59G
Monitor Driver	Recommended	O
OnScreen Control	Recommended	O

- Required and Recommended: You can download and install the latest version from the enclosed CD or from the LGE website (www.lg.com).
- Optional: You can download and install the latest version from the LGE website (www.lg.com).

Component and Button Description

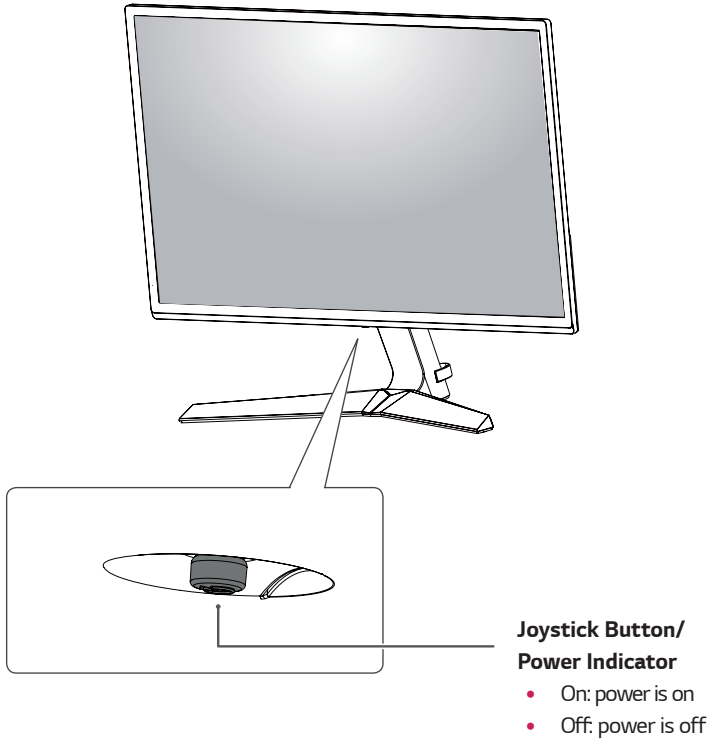

How to Use the Joystick Button

You can easily control the functions of the monitor by pressing the joystick button or moving it left/right with your finger.

Basic Functions

		Power on	Press the joystick button once with your finger to turn on the monitor.
		Power off	Press and hold the joystick button once with your finger to turn off the monitor.
		Volume Control	You can control the volume by moving the joystick button left/right.

NOTE

- The joystick button is located at the bottom of the monitor.

Input Connector

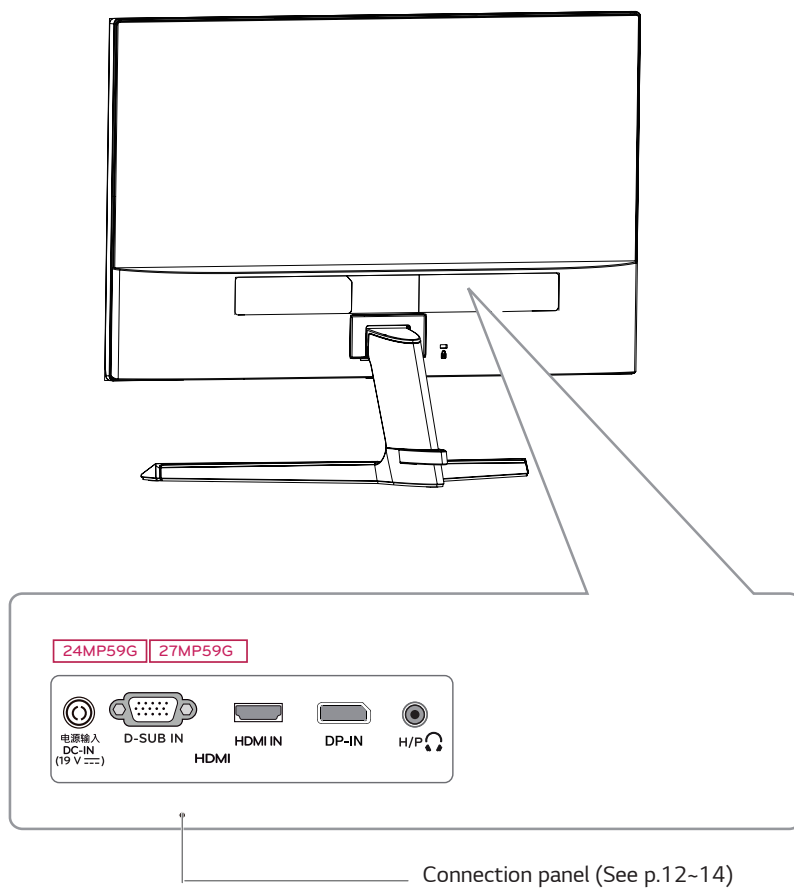

Moving and Lifting the Monitor

When moving or lifting the monitor, follow these instructions to prevent the monitor from being scratched or damaged and to ensure safe transportation regardless of its shape or size.

- It is advisable to place the monitor in the original box or packing material before attempting to move it.
- Before moving or lifting the monitor, disconnect the power cord and all cables.
- Hold the top and bottom of the monitor frame firmly. Do not hold the panel itself.

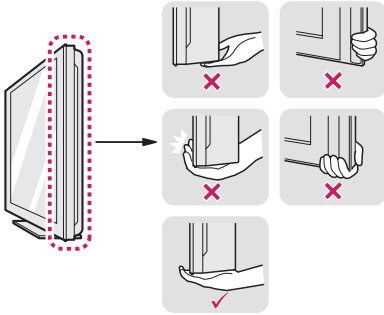

- When holding the monitor, the screen should face away from you to prevent it being scratched.

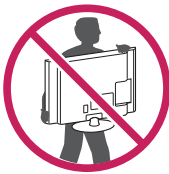

- When moving the monitor, avoid any strong shock or vibrations to the product.
- When moving the monitor, keep it upright, never turn the monitor on its side or tilt it sideways.

! CAUTION

- As far as possible, avoid touching the monitor screen. This may result in damage to the screen or some of the pixels used to create images.



- If you use the monitor panel without the stand base, its joystick button may cause the monitor to become unstable and fall, resulting in damage to the monitor or human injury. In addition, this may cause the joystick button to malfunction.

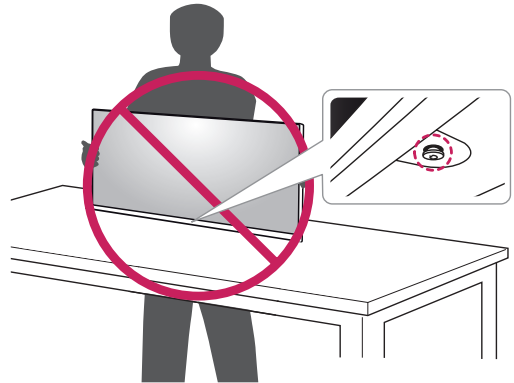

Setting up the Monitor set

Attaching the Stand Base

1

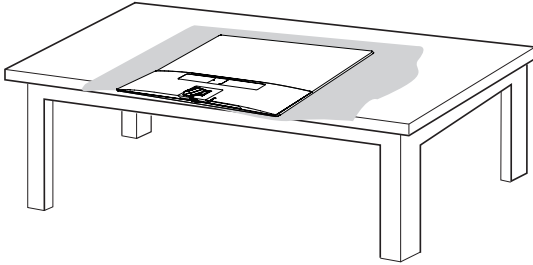

CAUTION

- To protect the screen from scratches, cover the surface with a soft cloth.

2

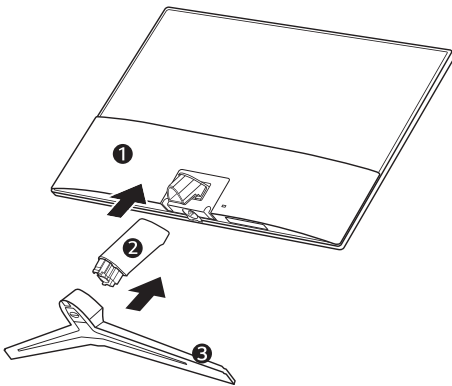

3

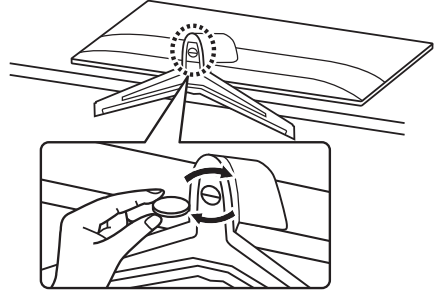

WARNING

- To avoid injury to the fingers and foot when Assembly Stand Body and Base, should hold Base when assembly stand body and base.



CAUTION

- Illustrations in this document represent typical procedures, so they may look different from the actual product.
- Do not carry the monitor upside down by just holding the stand base. This may cause the monitor to fall off the stand and could result in personal injury.
- When lifting or moving the monitor, do not touch the monitor screen. The force applied to the monitor screen may cause damage to it.
- Do not apply foreign substances (oils, lubricants, etc.) to the screw parts when assembling the product. (Doing so may damage the product.)
- Applying excessive force when tightening screws may cause damage to the monitor. Damage caused in this way will not be covered by the product warranty.



NOTE

- You can disassemble the stand in the reverse order of the assembly.

Mounting on a table

- 1 Lift and tilt the Monitor set into its upright position on a table.

Leave a 100 mm (minimum) space from the wall for proper ventilation.

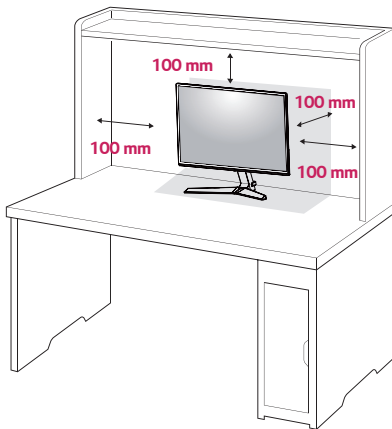

- 2 Connect the AC-DC Adapter and Power Cord to a wall outlet.

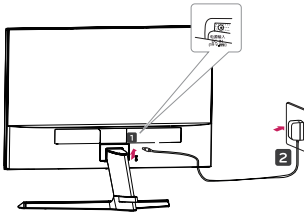

or

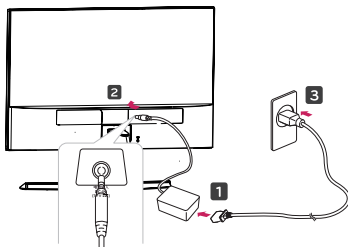

- 3 Press the joystick button on the bottom of the monitor to turn on the monitor.



CAUTION

- Unplug the power cord prior to moving or installing the monitor. There is risk of electric shock.

Using the cable holder

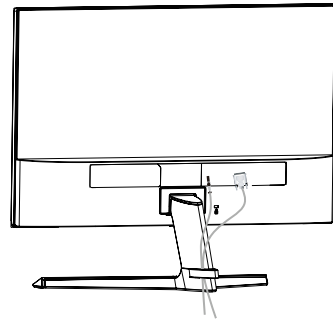
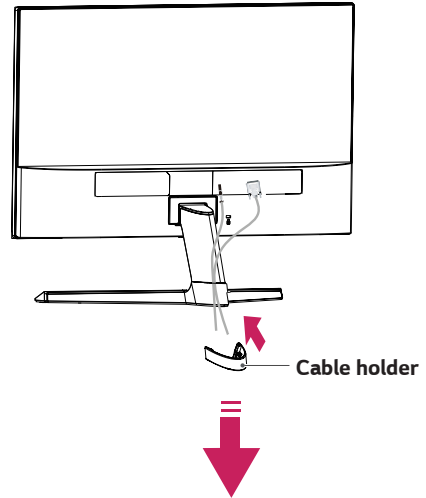

WARNING

When you adjust the angle, do not hold the bottom of the Monitor set frame as shown on the following illustration, as may injure your fingers.

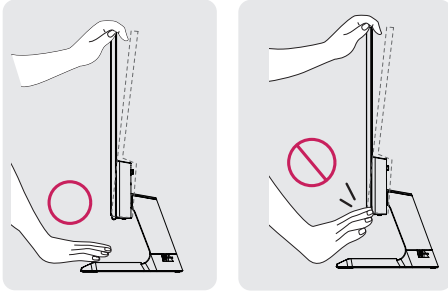

Do not touch or press the screen when adjusting the angle of the monitor.

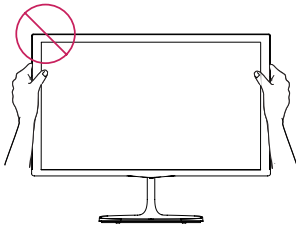

Do not hold this set like below picture. Monitor screen can detach from stand base and injure your body.

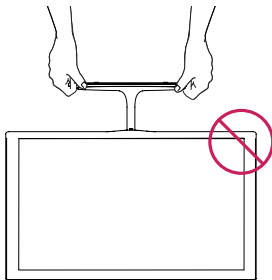

NOTE

Tilt from +15 to -2 degrees up or down to adjust the angle of the Monitor set to suit your view.

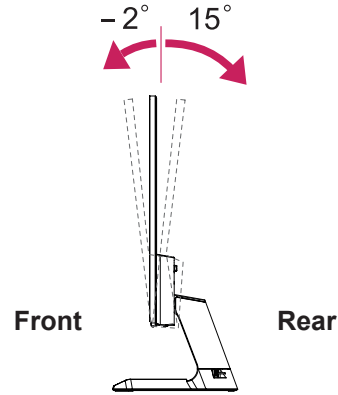

Using the Kensington security system

The Kensington security system connector is located at the back of the Monitor set. For more information of installation and using, refer to the manual supplied with the Kensington security system or visit <http://www.kensington.com>.

Connect the Kensington security system cable between the Monitor set and a table.

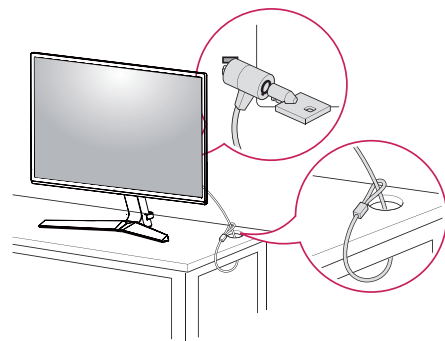

NOTE

- The Kensington security system is optional. You can obtain it from most electronics stores.

USING THE MONITOR SET

Connecting to a PC

- Your Monitor set supports Plug & Play*.
*Plug & Play: A PC recognizes a connected device that users connect to a PC and turn on, without device configuration or user intervention.

D-SUB connection

Transmits analog video from your PC to the Monitor set. Connect the PC and the Monitor set with the supplied D-sub 15 pin signal cable as shown in the following illustrations.

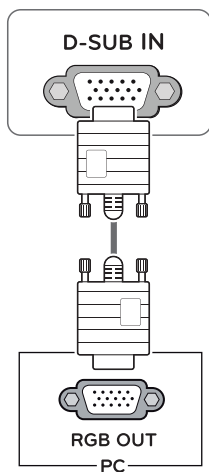

HDMI connection

Transmits the digital video and audio signals from your PC to the Monitor set. Connect the PC and the Monitor set with the HDMI cable as shown in the following illustrations.

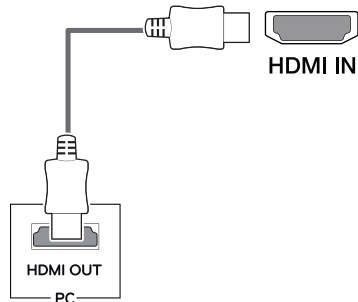

! NOTE

- If you use HDMI PC, it can cause compatibility problem.
- Use a certified cable with the HDMI logo attached. If you do not use a certified HDMI cable, the screen may not display or a connection error may occur.
- Recommended HDMI cable types
 - High-Speed HDMI®/™ Cable
 - High-Speed HDMI®/™ Cable with Ethernet

DisplayPort connection

Transmits the digital video and audio signals from your PC to the monitor. Connect your PC to the monitor using the display port cable as illustrated below. Press the menu button and then select the input option.

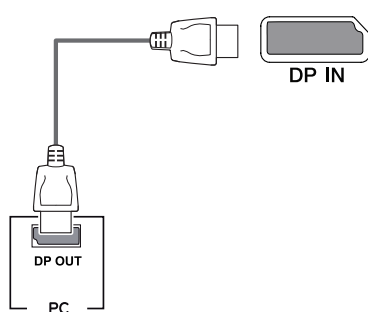

! NOTE

- There may be no video or audio output depending on the DP version of the PC.
- If you use generic cables not certified by LG, the screen may not display or there may be image noises.

Connecting to AV Devices

HDMI connection

Transmits the digital video and audio signals from your AV devices to the monitor. Connect your AV device to the monitor with the HDMI cable as illustrated below.

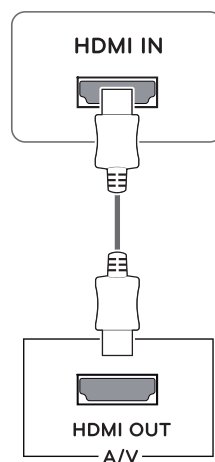

! NOTE

- If you use HDMI PC, it can cause compatibility problem.
- Use a certified cable with the HDMI logo attached. If you do not use a certified HDMI cable, the screen may not display or a connection error may occur.
- Recommended HDMI cable types
 - High-Speed HDMI[®]/TM Cable
 - High-Speed HDMI[®]/TM Cable with Ethernet

Connecting Peripherals

Connecting Headphones

Connect peripherals to the monitor via the headphones port. Connect as illustrated.

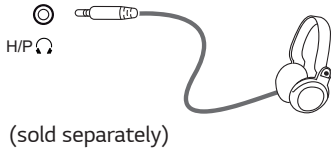

! NOTE

- Peripheral devices are sold separately.
- If you use angled headphones, it may cause a problem with connecting another external device to the monitor. Therefore, it is recommended to use straight headphones.



Angle Type

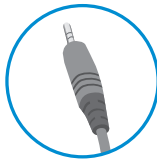

Straight Type



- Depending on the audio settings of the PC and external device, headphones and speaker functions may be limited.

CUSTOMIZING SETTINGS

Activating the Main Menu

- 1 Press the joystick button on the bottom of the monitor.
- 2 Move the joystick up/down (▲/▼) and left/right(◀/▶) to set the options.
- 3 Press the joystick button once more to close the main menu.



Button	Menu Status	Description
	Main menu disabled	Enables the main menu.
	Main menu enabled	Close the main menu. (Long press the button to turn off the monitor)
	◀ Main menu disabled	Adjusts the monitor volume level. (Only HDMI / Display Port.)
	◀ Main menu enabled	Enters the input features.
	▶ Main menu disabled	Adjusts the monitor volume level. (Only HDMI / Display Port.)
	▶ Main menu enabled	Enters the menu feature.
	▲ Main menu disabled	Enables the main menu.
	▲ Main menu enabled	Turns off the monitor.
	▼ Main menu disabled	Enables the main menu.
	▼ Main menu enabled	Enters the game mode feature.

Main Menu Features

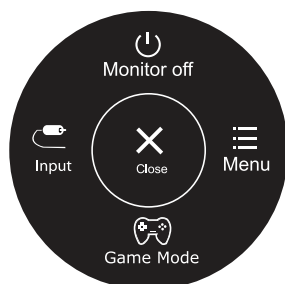

Main Menu	Description
Menu	Configures the screen settings.
Game Mode	You can change Picture Mode to a gaming mode.
Input	Sets input mode.
Monitor off	Turns off the monitor.
Close	Close the main menu.

Customizing settings

Menu > Quick Settings	Description	
Brightness	Adjusts the color contrast and brightness of the screen.	
Contrast		
Volume	Adjusts the volume.	
	 NOTE <ul style="list-style-type: none"> You can adjust Mute/ Unmute by moving the joystick button to ▼ in the Volume menu. 	
Ratio	Adjusts the screen ratio.	
	Wide	Displays the video in wide-screen, regardless of the video signal input.
	Original	Displays a video according to the input video signal aspect ratio.
SMART ENERGY SAVING	High	Enables SMART ENERGY SAVING you can save energy with this energy- high efficient.
	Low	Enables SMART ENERGY SAVING you can save energy with this energy- low efficient.
	Off	Disables SMART ENERGY SAVING .

* SMART ENERGY SAVING : Conserve energy by using luminance compensation algorithm.

NOTE



- The display may look the same for Wide, Original options at the recommended resolution (1920 x 1080).
- The ratio is disabled in the interlaced signal.
- Saving Data depends on the Panel. So, those values should be different from each panel and panel vendor. If option of SMART ENERGY SAVING is High or Low, monitor luminance become higher or lower depend on source.

Customizing settings

Menu > Picture	Description		
Picture Mode	Custom	Allows the user to adjust each element. The color mode of the main menu can be adjusted.	
	Reader 1	It is a mode that the screen is adjusted to the best for the newspaper. If you want screen more bright, you can control brightness in Menu OSD.	
	Reader 2	It is a mode that the screen is adjusted to the best for the cartoon. If you want screen more bright, you can control brightness in Menu OSD.	
	Photo	Optimizes the screen to view photos.	
	Cinema	Optimizes the screen to improve the visual effects of a video.	
	Color Weakness	This mode is for users who cannot distinguish between red and green. It enables users with color weakness to easily distinguish between the two colors.	
	FPS Game 1	This mode is optimized for FPS games.	
	FPS Game 2	It has a higher Black Stabilizer value than FPS Game 1. It is suitable for very dark FPS games.	
	RTS Game	This mode is optimized for RTS Game.	
	Custom(Game)	In this mode, users can customize various elements including game-related options.	
Picture Adjust	SUPER RESOLUTION+	High	Optimized picture quality is displayed when a user wants crystal clear images. It is effective for high quality video or game.
		Middle	The optimized picture quality is displayed when a user wants images between low and high modes for comfortable viewing. It is effective for UCC or SD video.
		Low	The optimized picture quality is displayed when a user wants smooth and natural images. It is effective for slow-moving pictures or still images.
		Off	Select this option for everyday viewing. SUPER RESOLUTION+ is turned off in this mode.
	Sharpness	Adjusts the sharpness of the screen.	
	Black Level	Sets the offset level (for HDMI only). • Offset: as a reference for a video signal, this is the darkest color the monitor can display.	
		High	Keeps the current contrast ratio of the screen.
		Low	Lowers the black levels and raises the white levels from the current contrast ratio of the screen.
	DFC	On	Adjusts the brightness automatically according to the screen.
		Off	Disables the DFC feature.
Game Adjust	Response Time	Sets a response time for displayed pictures based on the speed of the screen. For a normal environment, it is recommended that you use Middle. For a fast-moving picture, it is recommended that you use high. Setting to High may cause image sticking.	
		High	Sets the response time to High.
		Middle	Sets the response time to Middle.
		Low	Sets the response time to Low.
		Off	Does not use the response time improvement feature.

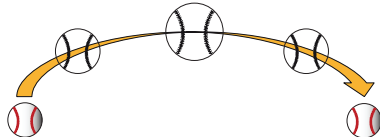
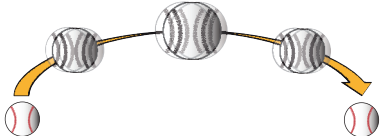

NOTE

- This is subsidiary for color weakness user. Therefore if you feel uncomfortable with the screen, please turn off this function.
- This function can't distinguish some colors in some images.

Game Adjust	FreeSync	Provides seamless and natural images by synchronizing the vertical frequency of the input signal with that of the output signal.
		 CAUTION <ul style="list-style-type: none"> Supported Interface: DisplayPort/HDMI. Supported Graphic Card : A graphic card that supports AMD's FreeSync is necessary. Supported Version : Make sure to update the graphic card to the latest driver. For more information and requirement, refer to AMD website at http://www.amd.com/FreeSync FreeSync and 1ms Motion Blur Reduction cannot be enabled simultaneously.
	On	FreeSync function on.
	Off	FreeSync function off.
	Black Stabilizer	<p>Black Stabilizer: You can control the black contrast to have better visibility in dark scenes. Increasing the Black Stabilizer value brightens the low gray level area on the screen. (You can easily distinguish objects on dark game screens.) Reducing the Black Stabilizer value darkens the low gray level area and increases the dynamic contrast on the screen.</p>
	1ms Motion Blur Reduction	<p>On</p> <p>This mode minimizes motion blur in fast-moving videos. To take full advantage of this function, select 1920X1080@75Hz before enabling 1ms Motion Blur Reduction.</p>  <p>This Function is available for 75hz vertical frequency</p>
		<p>Off</p> <p>Turns 1ms Motion Blur Reduction Mode off.</p> 
		<p> NOTE</p> <ul style="list-style-type: none"> To reduce motion blur, brightness is reduced with backlight control. 1ms Motion Blur Reduction and FreeSync feature can not used at the same time. This function is game-optimized. It is recommended to turn off when you are not using the gaming function.
	Cross Hair	<p>Cross Hair provides a mark on the center of the screen for First Person Shooter(FPS) games. Users can select the cross hair that fits their gaming environment among four different cross hairs.</p> <ul style="list-style-type: none"> When the monitor is off or enters energy saving mode, the Cross Hair feature is automatically turned off.

Color Adjust	Gamma	The higher the gamma value, the darker the image becomes. Likewise, the lower the gamma value, the lighter the image becomes. If you do not need to adjust the gamma settings, select Off.
	Color Temp	Selects the factory default picture color. Warm: Sets the screen color to a reddish tone. Medium: Sets the screen color between a red and blue tone. Cool: Sets the screen color to a bluish tone. Custom: The user can adjust it to red, green or blue by customization.
	Red/Green/Blue	You can customize the picture color using Red, Green, and Blue colors.
	Six Color	Meets the user requirements for colors through adjusting the color and saturation of the six colors (Red_Hue, Red_Saturation, Green_Hue, Green_Saturation, Blue_Hue, Blue_Saturation, Cyan_Hue, Cyan_Saturation, Magenta_Hue, Magenta_Saturation, Yellow_Hue, Yellow_Saturation) and saving the Six Color settings. *Hue: Adjusts tone of the screen. *Saturation: Adjusts the saturation of the screen colors. The lower the value, less saturated and bright the colors become. The higher the value, the more saturated and dark the colors become.
	Reset	Returns the color settings to the default settings.
Display	Horizontal	To move image left and right.
	Vertical	To move image up and down.
	Clock	To minimize any vertical bars or stripes visible on the screen background. The horizontal screen size will also change.
	Phase	To adjust the focus of the display. This item allows you to remove any horizontal noise and clear or sharpen the image of characters.

Customizing settings

Menu > General	Description	
Language	To choose the language in which the control names are displayed.	
Power LED	Turns the power indicator on the front side of the monitor on/off.	
	On	The power indicator is automatically turned on.
	Off	The power indicator is turned off.
Automatic Standby	The monitor will automatically switch to standby mode after a certain period.	
Resolution	User can set the desired resolution. This option is enabled only when the screen resolution on your computer is set to the following (D-SUB only).	
	 NOTE The function is enabled only when the screen resolution on your computer is set to the following, except that the PC output wrong resolution.	
	1024x768, 1280x768, 1360x768, 1366x768, Off	
	1280x960, 1600x900, Off	
	1440x900, 1600x900, Off	
OSD Lock	Prevents incorrect key input.	
	On	Key input is disabled.
	 NOTE <ul style="list-style-type: none"> All function except for the OSD Lock mode, brightness, Contrast, Input and Volume are disabled. 	
	Off	Key input is enabled.

Menu > Auto Configuration	Description
Do you want to Auto Configuration?	
Yes	Operate the Auto Configuration for optimal display in D-SUB.
Cancel	Cancel the select.

NOTE

- This function will be enable only in analog input.

Menu > Reset	Description
Do you want to reset your settings?	
Reset	Returns to the default settings.
Cancel	Cancel the select.

TROUBLESHOOTING

Check the following before calling for service.

No image appears	
Is the power cord of the display connected?	<ul style="list-style-type: none"> Check and see if the power cord is connected properly to the power outlet.
Is the power indicator light on?	<ul style="list-style-type: none"> Press the Power button.
Do you see an "Out of Range" message on the screen?	<ul style="list-style-type: none"> This message appears when the signal from the PC (video card) is out of horizontal or vertical frequency range of the display. See the 'Specifications' section of this manual and configure your display again.
Do you see a "NO SIGNAL" message on the screen?	<ul style="list-style-type: none"> After the monitor is on "NO SIGNAL", the monitor goes to DPM mode. This is displayed when the signal cable between the PC and the monitor is missing or disconnected. Check the cable and reconnect it.

Can't you control some functions in OSD?	
Can't you select some menu in OSD?	<ul style="list-style-type: none"> You can unlock the OSD controls at any time by entering the OSD lock menu and changing items to off.



CAUTION

- Check **Control Panel ► Display ► Settings** and see if the frequency or the resolution were changed. If yes, readjust the video card to the recommend resolution.
- If the recommended resolution (optimal resolution) is not selected, letters may be blurred and the screen may be dimmed, truncated or biased. Make sure to select the recommend resolution.
- The setting method can differ by computer and O/S (Operation System), and resolution mentioned above may not be supported by the video card performance. In this case, please ask to the computer or the video card manufacturer.

Display image is incorrect	
The screen color is mono or abnormal.	<ul style="list-style-type: none"> Check if the signal cable is properly connected and use a screwdriver to fasten if necessary. Make sure the video card is properly inserted in the slot. Set the color setting higher than 24 bits (true color) at Control Panel ► Settings.
The screen blinks.	<ul style="list-style-type: none"> Check if the screen is set to interlace mode and if yes, change it to the recommend resolution.

Do you see an "Unrecognized monitor, Plug&Play (VESA DDC) monitor found" message?	
Have you installed the display driver?	<ul style="list-style-type: none"> Be sure to install the display driver from the display driver CD (or diskette) that comes with your display. Or, you can also download the driver from our website: http://www.lg.com. Make sure to check if the video card supports Plug&Play function.

The screen is flickering.	
Did you select the recommended resolution?	<ul style="list-style-type: none"> If the selected resolution is HDMI 1080i 60/50 Hz, the screen may be flickering. Change the resolution to the recommended resolution 1080P.

SPECIFICATIONS

24MP59G

LCD Screen	Type	TFT (Thin Film Transistor) LCD(Liquid Crystal Display) Screen
	Pixel Pitch	0.2745mm x 0.2745mm
Resolution	Maximum Resolution	1920 x 1080 @ 75 Hz
	Recommended Resolution	1920 x 1080 @ 75 Hz
Video Signal	Horizontal Frequency	HDMI : 30 kHz to 85 kHz DP : 30 kHz to 85 kHz D-SUB: 30 kHz to 85 kHz
	Vertical Frequency	HDMI : 40 Hz to 75 Hz DP : 40 Hz to 75 Hz D-SUB: 40 Hz to 75 Hz
	Synchronization	Separate Sync, Digital.
Input Connector	HDMI IN, DP(DisplayPort) IN, D-SUB IN, HP OUT	
Power Input	19 V $\overline{=}$ 1.3 A	
Power Consumption	On Mode : 17.1 W Typ. (ENERGY STAR® standard) * 22 W Typ. (Outgoing condition) ** Sleep Mode \leq 0.3 W Off Mode \leq 0.3 W	
AC/DC adaptor	Type ADS-40SG-19-3 19032G, manufactured by SHENZHEN HONOR ELECTRONIC or Type ADS-40FSG-19 19032GPG-1, manufactured by SHENZHEN HONOR ELECTRONIC or Type ADS-40FSG-19 19032GPBR-1, manufactured by SHENZHEN HONOR ELECTRONIC or Type ADS-40FSG-19 19032GPI-1, manufactured by SHENZHEN HONOR ELECTRONIC or Type ADS-40FSG-19 19032GPCU-1, manufactured by SHENZHEN HONOR ELECTRONIC or Type ADS-32FSG-19 19032EPCU-1L, manufactured by SHENZHEN HONOR ELECTRONIC or Type LCAP21A, manufactured by LIEN CHANG ELECTRONIC ENTERPRISE or Type LCAP26A-A, manufactured by LIEN CHANG ELECTRONIC ENTERPRISE or Type LCAP26A-E, manufactured by LIEN CHANG ELECTRONIC ENTERPRISE or Type LCAP26A-I, manufactured by LIEN CHANG ELECTRONIC ENTERPRISE or Type LCAP26A-B, manufactured by LIEN CHANG ELECTRONIC ENTERPRISE or Type LCAP51A, manufactured by LIEN CHANG ELECTRONIC ENTERPRISE or Type PA-1031-23, manufactured by Lite-On Technology Corporation OUTPUT: 19 V $\overline{=}$ 1.7 A	
Environmental conditions	Operating Temperature	0 °C to 40 °C
	Operating Humidity	Less than 80%
	Storage Temperature	-20 °C to 60 °C
	Storage Humidity	Less than 85 %
Dimension	Monitor Size (Width x Height x Depth)	
	With Stand	550.5 mm x 419.9 mm x 204.1 mm
	Without Stand	550.5 mm x 332.1 mm x 85.5 mm
Weight (Without Packaging)	With Stand	3.2 Kg
	Without Stand	2.8 Kg

Product specifications shown above may be changed without prior notice due to upgrade of product functions.

* The power consumption level can be different by operating condition and monitor setting.

* The On mode power consumption is measured with ENERGY STAR® test standard.

** The On mode power consumption is measured with LGE test standard (Full White pattern , Maximum resolution).

SPECIFICATIONS

27MP59G

LCD Screen	Type	TFT (Thin Film Transistor) LCD(Liquid Crystal Display) Screen
	Pixel Pitch	0.3114mm x 0.3114mm
Resolution	Maximum Resolution	1920 x 1080 @ 75Hz
	Recommended Resolution	1920 x 1080 @ 75Hz
Video Signal	Horizontal Frequency	HDMI : 30 kHz to 85 kHz DP : 30 kHz to 85 kHz D-SUB: 30 kHz to 85 kHz
	Vertical Frequency	HDMI : 40 Hz to 75 Hz DP : 40 Hz to 75 Hz D-SUB: 40 Hz to 75 Hz
	Synchronization	Separate Sync, Digital.
Input Connector	HDMI IN, DP(DisplayPort) IN, D-SUB IN, HP OUT	
Power Input	19 V ---1.6 A	
Power Consumption	On Mode : 20.3 W Typ. (ENERGY STAR® standard) * 26.5 W Typ. (Outgoing condition) ** Sleep Mode ≤ 0.3 W Off Mode ≤ 0.3 W	
AC/DC adaptor	Type ADS-45SN-19-3 19040G, manufactured by SHENZHEN HONOR ELECTRONIC or Type LCAP21C, manufactured by LIEN CHANG ELECTRONIC ENTERPRISE or Type LCAP26B-E, manufactured by LIEN CHANG ELECTRONIC ENTERPRISE	
	OUTPUT: 19 V --- 2.1 A	
Environmental conditions	Operating Temperature	0 °C to 40 °C
	Operating Humidity	Less than 80%
	Storage Temperature	-20 °C to 60 °C
	Storage Humidity	Less than 85 %
Dimension	Monitor Size (Width x Height x Depth)	
	With Stand	634.1 mm x 470.5 mm x 204.1mm
	Without Stand	634.1 mm x 382.7 mm x 91.1 mm
Weight (Without Packaging)	With Stand	4.3 kg
	Without Stand	3.9 kg

Product specifications shown above may be changed without prior notice due to upgrade of product functions.

* The power consumption level can be different by operating condition and monitor setting.

* The On mode power consumption is measured with ENERGY STAR® test standard.

** The On mode power consumption is measured with LGE test standard (Full White pattern , Maximum resolution).

Preset Modes (Resolution)

D-SUB/ HDMI/ DP PC Timing

Display Modes (Resolution)	Horizontal Frequency(kHz)	Vertical Frequency(Hz)	Polarity(H/V)	
720 x 400	31.468	70	-/+	
640 x 480	31.469	60	-/-	
640 x 480	37.500	75	-/-	
800 x 600	37.879	60	+/+	
800 x 600	46.875	75	+/+	
1024 x 768	48.363	60	-/-	
1024 x 768	60.023	75	+/+	
1152 x 864	67.500	75	+/+	
1280 x 1024	63.981	60	+/+	
1280 x 1024	79.976	75	+/+	
1680 x 1050	65.290	60	-/+	
1920 x 1080	67.500	60	+/+	
1920 x 1080	83.89	75	+/+	Recommend Mode

HDMI AV Timing

Factory support mode (Preset Mode)	Horizontal Frequency(kHz)	Vertical Frequency(Hz)	HDMI
480P	31.50	60	0
576P	31.25	50	0
720P	37.50	50	0
720P	45.00	60	0
1080P	56.25	50	0
1080P	67.50	60	0 Recommend Mode

Indicator

Mode	LED Color
On Mode	White
Sleep Mode	Off
Off Mode	Off



Make sure to read the Safety Precautions before using the product.
Keep the Owner's Manual (CD) in an accessible place for future reference.

The model and serial number of the SET is located on the back and one side of the SET. Record it below should you ever need service.

MODEL _____

SERIAL _____



ENERGY STAR® is a set of power-saving guidelines issued by the U.S. Environmental Protection Agency (EPA).

As an ENERGY STAR® Partner LGE U. S. A., Inc. has determined that this product meets the ENERGY STAR® guidelines for energy efficiency.

Refer to ENERGYSTAR.gov for more information on the ENERGY STAR® program.