

PRO 24X Series

Personal Computer

MS-AEC1

Contents

Copyright and Trademarks Notice	iii
Revision	iii
Upgrade and Warranty	iv
Acquisition of Replaceable Parts	iv
Technical Support	iv
Green Product Features	iv
Environmental Policy	v
Chemical Substances Information	v
Battery Information	v
Safety Instructions	vi
CE Conformity	viii
FCC-B Radio Frequency Interference Statement	viii
WEEE Statement	viii
RoHS Statement	ix
Overview	1-1
Packing Contents	1-2
System Overview	1-3
Component Replacement & Upgrade	1-8
Getting Started	2-1
Safety & Comfort Tips	2-2
Connecting the Power	2-3
Adjusting the Monitor	2-4
System Operations	3-1
Power Management	3-2
Network Connection (Windows 10)	3-4
System Recovery (Windows 10)	3-7
System Recovery (F3 Hotkey Recovery) (Optional)	3-11
Troubleshooting	A-1

Copyright and Trademarks Notice

Copyright © Micro-Star Int'l Co., Ltd. All rights reserved. The MSI logo used is a registered trademark of Micro-Star Int'l Co., Ltd. All other marks and names mentioned may be trademarks of their respective owners. No warranty as to accuracy or completeness is expressed or implied. MSI reserves the right to make changes to this document without prior notice.

Revision

Revision	Date
V1.0	2018/ 03

Upgrade and Warranty

Please note that certain components preinstalled in the product may be upgradable or replaceable by user's request. For any further information about the product users purchased, please contact the local dealer. Do not attempt to upgrade or replace any component of the product if you are not an authorized dealer or service center, since it may cause the warranty void. It is strongly recommended that you contact the authorized dealer or service center for any upgrade or replace service.

Acquisition of Replaceable Parts

Please be noticed that the acquisition of replaceable parts (or compatible ones) of the product users purchased in certain countries or territories may be fulfilled by the manufacturer within 5 years at most since the product has been discontinued, depending on the official regulations declared at the time. Please contact the manufacturer via <http://www.msi.com/support/> for the detailed information about the acquisition of spare parts.

Technical Support

If a problem arises with your system and no solution can be obtained from the user's manual, please contact your place of purchase or local distributor. Alternatively, please try the following help resources for further guidance. Visit the MSI website for technical guide, BIOS updates, driver updates and other information via <http://www.msi.com/support/>

Green Product Features

- ☐ Reduced energy consumption during use and stand-by
- ☐ Limited use of substances harmful to the environment and health
- ☐ Easily dismantled and recycled
- ☐ Reduced use of natural resources by encouraging recycling
- ☐ Extended product lifetime through easy upgrades
- ☐ Reduced solid waste production through take-back policy

Environmental Policy

- ☐ The product has been designed to enable proper reuse of parts and recycling and should not be thrown away at its end of life.
- ☐ Users should contact the local authorized point of collection for recycling and disposing of their end-of-life products.
- ☐ Visit the MSI website and locate a nearby distributor for further recycling information.
- ☐ Users may also reach us at gpcontdev@msi.com for information regarding proper Disposal, Take-back, Recycling, and Disassembly of MSI products.



Chemical Substances Information

In compliance with chemical substances regulations, such as the EU REACH Regulation (Regulation EC No. 1907/2006 of the European Parliament and the Council), MSI provides the information of chemical substances in products at:
http://www.msi.com/html/popup/csr/evmtprrt_pcm.html

Battery Information



European Union:

Batteries, battery packs, and accumulators should not be disposed of as unsorted household waste. Please use the public collection system to return, recycle, or treat them in compliance with the local regulations.



Taiwan:

For better environmental protection, waste batteries should be collected separately for recycling or special disposal.

廢電池請回收

California, USA:

The button cell battery may contain perchlorate material and requires special handling when recycled or disposed of in California.

For further information please visit:

<http://www.dtsc.ca.gov/hazardouswaste/perchlorate/>

Danger of explosion if battery is incorrectly replaced. Replace only with the same or equivalent type recommended by the manufacturer.

Safety Instructions



- ☐ Read the safety instructions carefully and thoroughly.
- ☐ All cautions and warnings on the equipment or user's manual should be noted.



Keep the User's Guide that comes with the package for future reference.



Keep this equipment away from humidity and high temperature.



Lay this equipment on a reliable flat surface before setting it up.



- ☐ Make sure that the power voltage is within its safety range and has been adjusted properly to the value of 100~240V before connecting the equipment to the power outlet. Do not disable the protective earth pin from the plug. The equipment must be connected to an earthed mains socket-outlet.
- ☐ Always unplug the AC power cord before installing any add-on card or module to the equipment.
- ☐ Always disconnect the AC power cord or switch the wall socket off if the equipment would be left unused for a certain time to achieve zero energy consumption.
- ☐ Rating: (Option 1) 65W, 19V --- 3.42A,
(Option 2) 90W, 19V --- 4.74A.



The ventilator on the enclosure is used for air convection and to prevent the equipment from overheating. Do not cover the ventilator.



Do not leave the equipment in an unconditioned environment with a storage temperature above 60°C (140°F) or below 0°C (32°F), which may damage the equipment. **NOTE:** The maximum operating temperature is around 40°C.



Never pour any liquid into the opening that could damage or cause electrical shock.



Place the power cord in a way that people are unlikely to step on it. Do not place anything on the power cord.

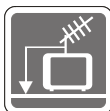

- ☐ When installing the coaxial cable to the TV Tuner, it is necessary to ensure that the metal shield is reliably connected to protective earthing system of the building.
- ☐ Cable distribution system should be grounded (earthed) in accordance with ANSI/NFPA 70, the National Electrical Code (NEC), in particular Section 820.93, Grounding of Outer Conductive Shield of a Coaxial Cable.



Always keep the strong magnetic or electrical objects away from the equipment.

If any of the following situations arises, get the equipment checked by service personnel:



- ☐ The power cord or plug is damaged.
- ☐ Liquid has penetrated into the equipment.
- ☐ The equipment has been exposed to moisture.
- ☐ The equipment does not work well or you can not get it work according to user's manual.
- ☐ The equipment has dropped and damaged.
- ☐ The equipment has obvious sign of breakage.

1. The optical storage devices are classified as CLASS 1 LASER PRODUCT. Use of controls or adjustments or performance of procedures other than those specified is prohibited.
2. Do not touch the lens inside the drive.

CE Conformity

Hereby, Micro-Star International CO., LTD declares that this device is in compliance with the essential safety requirements and other relevant provisions set out in the European Directive.



FCC-B Radio Frequency Interference Statement

This equipment has been tested and found to comply with the limits for a Class B digital device, pursuant to Part 15 of the FCC Rules. These limits are designed to provide reasonable protection against harmful interference in a residential installation. This equipment generates, uses and can radiate radio frequency energy and, if not installed and used in accordance with the instruction manual, may cause harmful interference to radio communications. However, there is no guarantee that interference will not occur in a particular installation. If this equipment does cause harmful interference to radio or television reception, which can be determined by turning the equipment off and on, the user is encouraged to try to correct the interference by one or more of the measures listed below:



- Reorient or relocate the receiving antenna.
- Increase the separation between the equipment and receiver.
- Connect the equipment into an outlet on a circuit different from that to which the receiver is connected.
- Consult the dealer or an experienced radio/television technician for help.

Notice 1

The changes or modifications not expressly approved by the party responsible for compliance could void the user's authority to operate the equipment.

Notice 2

Shielded interface cables and AC power cord, if any, must be used in order to comply with the emission limits.

This device complies with Part 15 of the FCC Rules. Operation is subject to the following two conditions:

1. this device may not cause harmful interference, and
2. this device must accept any interference received, including interference that may cause undesired operation.

WEEE Statement

Under the European Union ("EU") Directive on Waste Electrical and Electronic Equipment, Directive 2002/96/EC, which takes effect on August 13, 2005, products of "electrical and electronic equipment" cannot be discarded as municipal waste anymore and manufacturers of covered electronic equipment will be obligated to take back such products at the end of their useful life.



RoHS Statement

Japan JIS C 0950 Material Declaration

A Japanese regulatory requirement, defined by specification JIS C 0950, mandates that manufacturers provide material declarations for certain categories of electronic products offered for sale after July 1, 2006.

http://www.msi.com/html/popup/csr/cemm_jp.html

http://tw.msi.com/html/popup/csr_tw/cemm_jp.html

India RoHS

This product complies with the "India E-waste (Management and Handling) Rule 2011" and prohibits use of lead, mercury, hexavalent chromium, polybrominated biphenyls or polybrominated diphenyl ethers in concentrations exceeding 0.1 weight % and 0.01 weight % for cadmium, except for the exemptions set in Schedule 2 of the Rule.

Turkey EEE regulation

Conforms to the EEE Regulations of the Republic Of Turkey

Ukraine restriction of hazardous substances

The equipment complies with requirements of the Technical Regulation, approved by the Resolution of Cabinet of Ministry of Ukraine as of December 3, 2008 № 1057, in terms of restrictions for the use of certain dangerous substances in electrical and electronic equipment.

Vietnam RoHS

As from December 1, 2012, all products manufactured by MSI comply with Circular 30/2011/TT-BCT temporarily regulating the permitted limits for a number of hazardous substances in electronic and electric products.



1

Overview

This system is designed with green commerce and smart digital lifestyle, using an LED backlit display to increase clarity, while reducing the burden to the eyes. With the compact chassis and flexible base/ stand, it blends technology with life, making computers easier to use - suitable for both individuals and businesses.

Packing Contents



All-in-One PC

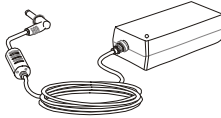

AC/DC Adapter

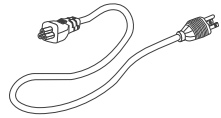

AC Power Cord



Keyboard (Optional)



Mouse (Optional)

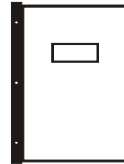

User Manual &
Quick Guide (Optional)

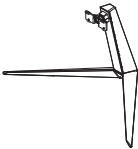

V Base (Optional)

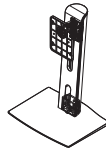

Lift Stand (Optional)

- * Please contact us immediately if any of the items is damaged or missing.
- * The illustrations are for reference only and your packing contents may slightly vary depending on the model you purchased.

System Overview

➤ Rear View

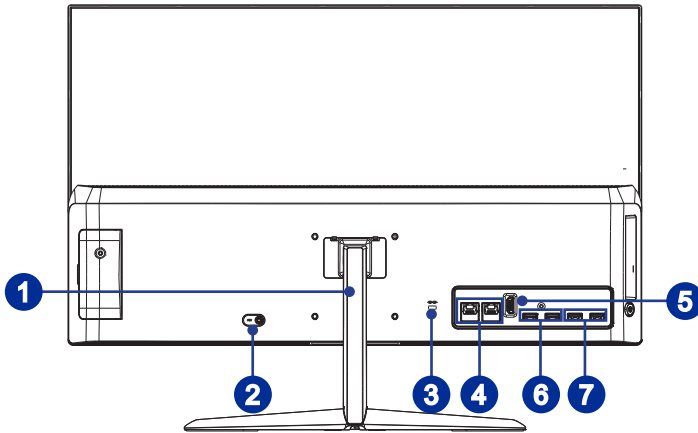

1 Base/ Stand (Optional)

Use this base/ stand to position your system on a flat and stable surface.

2 Power Jack

The AC/DC adapter converts AC power to DC power for this jack. Power supplied through this jack supplies power to the PC. To prevent damage to the PC, always use the supplied power adapter.

3 Kensington Lock Port

This AIO PC provides a Kensington lock port, which allows users to secure the AIO PC in place with a key or some mechanical PIN device and attached through a rubberised metal cable. The end of the cable has a small loop which allows the whole cable to be looped around a permanent object, such as a heavy table or other similar equipment, thus securing the AIO PC in place.

4 RJ-45 LAN Jack (Optional)

The standard RJ-45 LAN jack is provided for connection to the Local Area Network (LAN). You can connect a network cable to it.

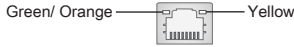

LED	Color	LED State	Condition
Right	Yellow	Off	LAN link is not established.
		On (steady state)	LAN link is established.
		On (brighter & pulsing)	The computer is communicating with another computer on the LAN.
Left	Green	Off	10 Mbit/sec data rate is selected.
		On	100 Mbit/sec data rate is selected.
	Orange	On	1000 Mbit/sec data rate is selected.

5 HDMI-Out Port **HDMI**[™]

HIGH-DEFINITION MULTIMEDIA INTERFACE

The High-Definition Multimedia Interface (HDMI) is an all-digital audio/video interface capable of transmitting uncompressed streams. HDMI supports all TV format, including standard, enhanced, or high-definition video, plus multi-channel digital audio on a single cable.

6 USB 3.1 Gen1 Port (Type-A)

The USB (Universal Serial Bus) port is for attaching USB devices such as keyboard, mouse, or other USB-compatible devices. It supports up to 5Gbit/s (SuperSpeed) data transfer rate. The USB 3.1 Gen1 port is backward-compatible with USB 2.0 devices.

7 USB 2.0 Port (Type-A)

The USB (Universal Serial Bus) port is for attaching USB devices such as keyboard, mouse, or other USB-compatible devices. It supports up to 480Mbit/s (Hi-Speed) data transfer rate.

► Side View

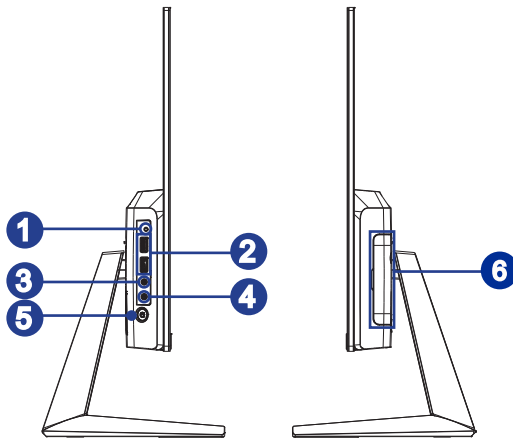

1 Hard Disk Drive LED

This indicator shows the activity status of the HDD. It flashes when the system is accessing data on the HDD and remains off when no disk activity is detected.

2 USB 3.1 Gen1 Port (Type-A) (with MSI SuperCharger Technology) (Optional)

The USB (Universal Serial Bus) port is for attaching USB devices such as keyboard, mouse, or other USB-compatible devices. It supports up to 5Gbit/s (SuperSpeed) data transfer rate. The USB 3.1 Gen1 port is backward-compatible with USB 2.0 devices. With MSI SuperCharger Technology, not only does it function as normal USB 3.0 port, but it also enables users to charge USB devices even when the system is turned off.

3 Line-Out Jack

This connector is provided for headphones or speakers.

4 Microphone

The built-in microphone can be used for video chatting online.

5**System Power Button/ LED**

Press the system power button to turn the system on or off. The power LED glows when the system is turned on and goes off when the system is shut down. In terms of power saving, the LED blinks in S3 (Suspend to RAM) mode and goes off in S4 (Suspend to Disk) mode.

6**Maintain Door****Important**

- 1. We suggest that you connect the AC/DC adapter to your AIO PC first and then connect the AC power cord to the socket-outlet for safety concerns.*
- 2. High-speed devices are recommended for USB 3.1 ports whereas low-speed devices, such as mouse or keyboard, are suggested to be plugged into the USB 2.0 ports.*

► **Top & Bottom View**

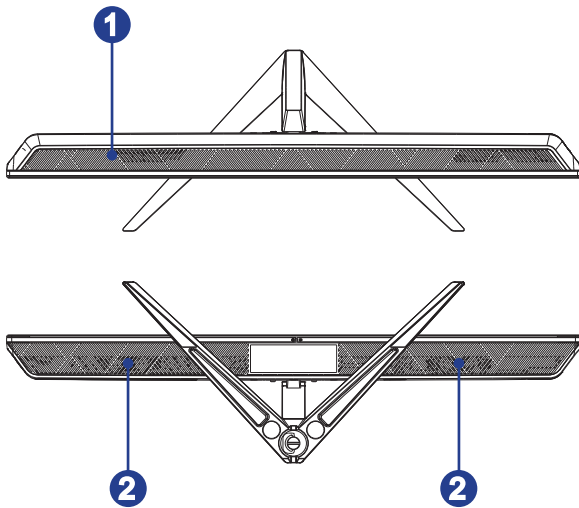
**1****Ventilator**

The ventilator on the enclosure is used for air convection and to prevent the equipment from overheating. Do not cover the ventilator.

2**Stereo Speakers**

The built-in stereo speakers deliver high quality sound with stereo system.

Component Replacement & Upgrade

Please note that certain components preinstalled in the product may be upgradable or replaceable by user's request depending on the models users purchased.

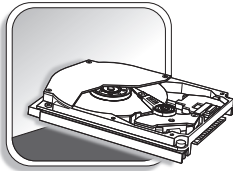
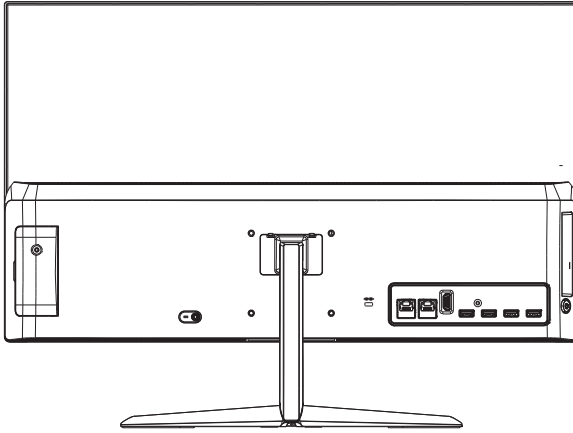

For any further information on the product users purchased, please contact the local dealer. Do not attempt to upgrade or replace any component of the product if you are not an authorized dealer or service center, since it may cause the warranty void. It is strongly recommended that you contact the authorized dealer or service center for any upgrade or replace service.

2

Getting Started

This chapter provides you with the information on hardware setup procedures. While connecting peripheral devices, be careful in holding the devices and use a grounded wrist strap to avoid static electricity.

Safety & Comfort Tips

The AIO PC is a portable platform that allows you to work anywhere. However, choosing a good workspace is important if you have to work with your PC for a long period of time.

1. Your work area should have enough illumination.
2. Choose the proper desk and chair and adjust their height to fit your posture when operating.
3. When sitting on the chair, sit straight and keep a good posture. Adjust the chair's back (if available) to support your back comfortably.
4. Place your feet flat and naturally on the floor, so that your knees and elbows have the proper position (about 90-degree) when operating.
5. Put your hands on the desk naturally to support your wrists.
6. Adjust the angle/position of the AIO PC to have an optimal view.
7. Avoid using your PC in a place where discomfort may occur (such as on the bed).
8. The AIO PC is an electrical device. Please treat it with great care to avoid personal injury.

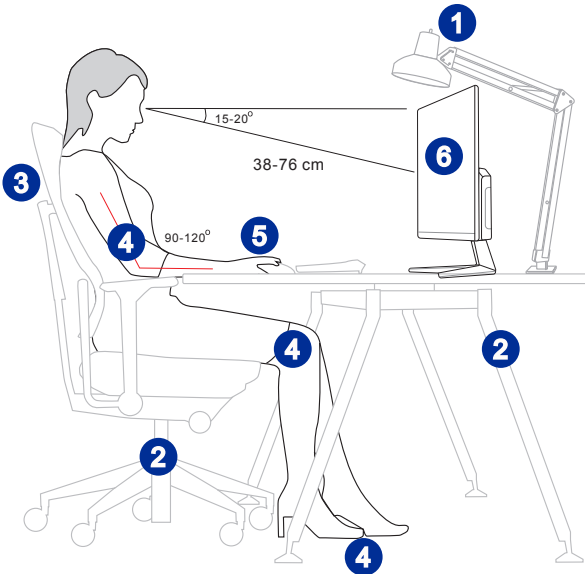

Connecting the Power

1. Connect the adapter to the AIO PC and plug in the power cord.

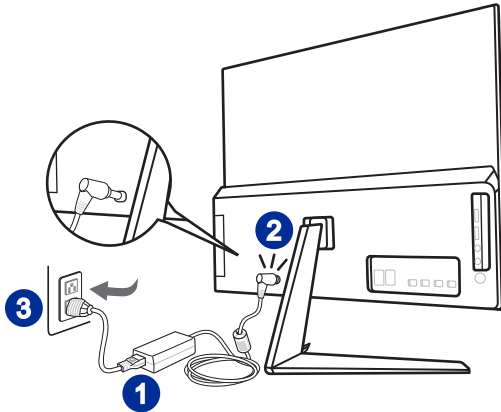

2. Press the power button to power on the AIO PC.

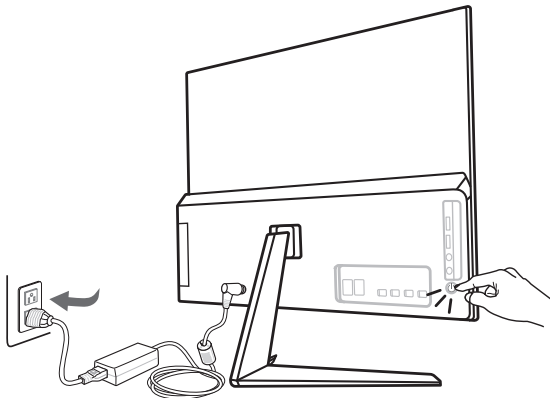

Adjusting the Monitor

This monitor is designed to maximize your viewing comfort with its adjustment capabilities such as tilt and lift.

Important

- *The illustrations are for reference only. Your AIO PC may vary in appearance.*
- *Please make sure the AIO PC has been grounded to earth through the AC power cord and the electrical outlet before powering on the AIO PC.*
- *Do not use any sharp objects on the display panel.*
- *Avoid pressing the display panel when adjusting.*

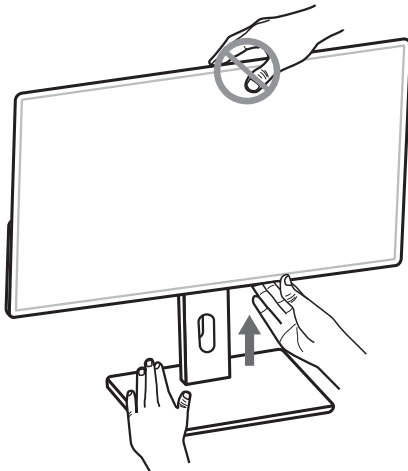
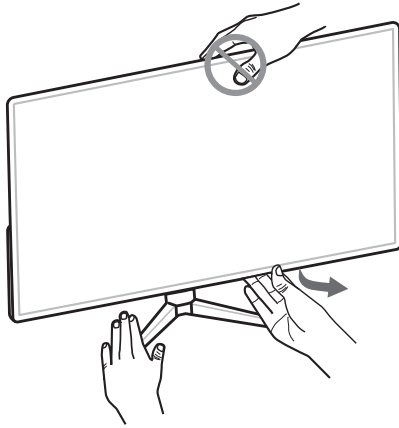

3

System Operations

This chapter provides you with essential information on system operations.

Important

All information is subject to change without prior notice.

Power Management

Power management of personal computers (PCs) and monitors has the potential to save significant amounts of electricity as well as deliver environmental benefits.

To be energy efficient, turn off your display or set your PC to sleep mode after a period of user inactivity.

► Power Management in Windows 10

- [Power Options] in Windows OS allow you to control the power management features of your display, hard drive, and battery. Right-click [Start] , select [Control Panel] from the list and then click [System and Security].

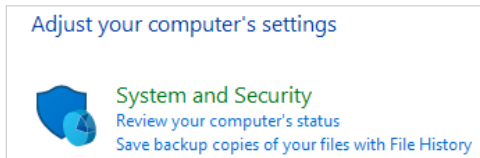

Select [Power Options] and choose a power plan that suits your personal needs. You may also fine-tune the settings by clicking [Change plan settings].

- The Shut Down Computer menu presents the options of Sleep (S3/S4) & Shut Down (S5) for rapid and easy management of your system power.

► Power Management through ENERGY STAR qualified monitors

The power management feature allows the computer to initiate a low-power or "Sleep" mode after a period of user inactivity. When used with an external ENERGY STAR qualified monitor, this feature also supports similar power management features of the monitor. To take advantage of these potential energy savings, the power management feature has been preset to behave in the following ways when the system is operating on AC power:

- Turn off the display after 10 minutes
- Initiate Sleep after 30 minutes



ENERGY STAR

► Waking the System Up

The computer shall be able to wake up from power saving mode in response to a command from any of the following:

- the power button,
- the network (Wake On LAN),
- the mouse,
- the keyboard.



Energy Saving Tips:

- Turn off the monitor by pressing the monitor power button after a period of user inactivity.
- Tune the settings in Power Options under Windows OS to optimize your PC's power management.
- Install power saving software to manage your PC's energy consumption.
- Always disconnect the AC power cord or switch the wall socket off if your PC would be left unused for a certain time to achieve zero energy consumption.

Network Connection (Windows 10)

► Wired Network

1. Right-click [Start]  and select [Network Connections] from the list.
2. Select [Ethernet] and then [Network and Sharing Center].

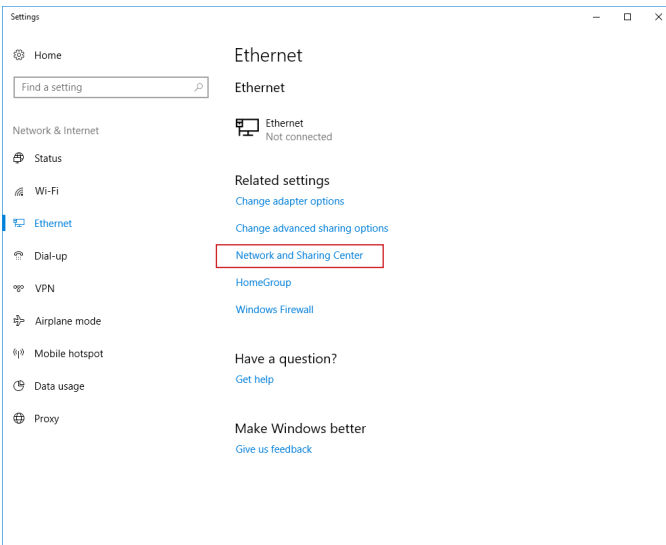

3. Select [Set up a new connection or network].

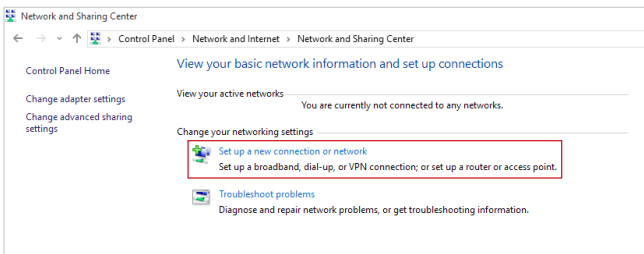

4. Choose [Connect to the Internet] and click [Next].
5. Select [Broadband (PPPoE)] to connect using DSL or cable that requires a user name and password.

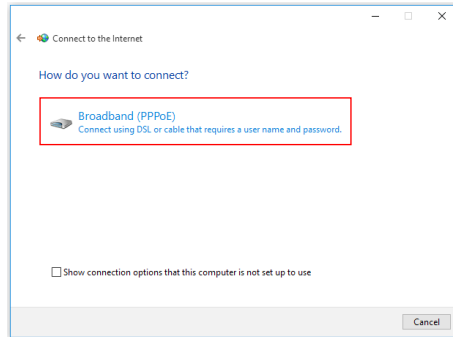

6. Type the information from your Internet Service Provider (ISP) and click [Connect] to establish your LAN connection.

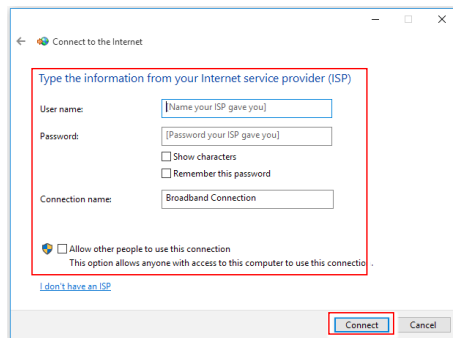

► Wireless Network

1. Go to [Start] , click [Settings] and select [Network and Internet].
2. A list of available WLAN connections pops up. Choose a connection from the list.
3. To establish a new connection, select [Network and Sharing Center].

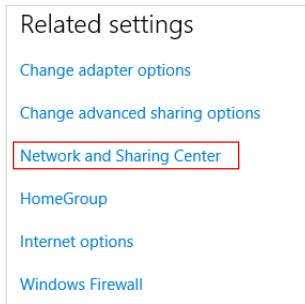

4. Select [Set up a new connection or network].
5. Followingly, choose [Manually connect to a wireless network] and click [Next] to continue.
6. Enter information for the wireless network you intend to add and click [Next] to proceed.

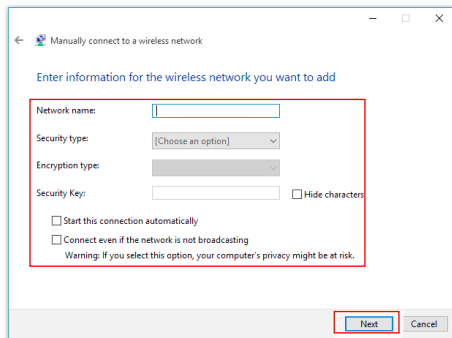

7. A new WLAN connection has been made.

System Recovery (Windows 10)

The purposes for using the System Recovery Function may include:

- Restore the system back to the initial status of original manufacturer's default settings.
- When some errors have occurred to the operating system in use.
- When the operating system is affected by virus and is not able to work normally.
- When you want to install the OS with other built-in languages.

Before using the System Recovery Function, please back up the important data saved on your system drive to other storage devices.

If the following solution fails to recover your system, please contact the authorized local distributor or service center for further assistance.

Reset this PC

1. Go to [Start] , click [Settings] and select [Update and security].
2. Select [Recovery] and click [Get started] under [Reset this PC] to start the system recovery.

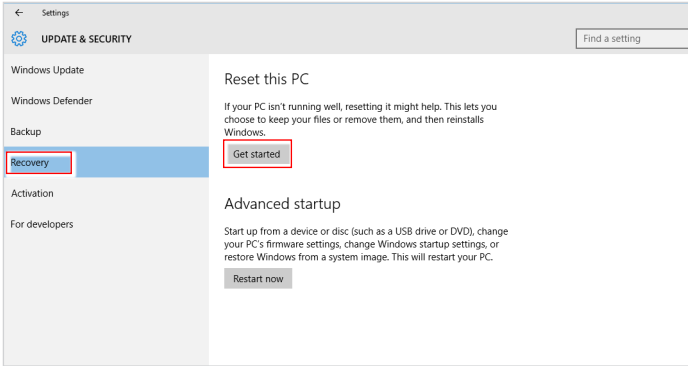

3-8

3. The [Choose an option] screen pops up. Choose between [Keep my files] and [Remove everything].

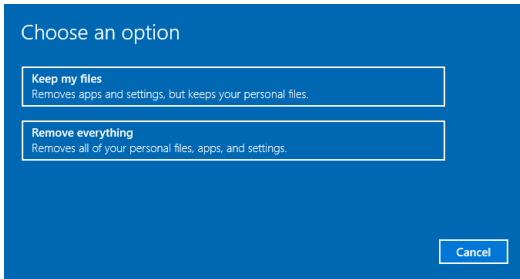

Reset this PC	Keep my files		
	Remove everything	Only the drive where Windows is installed	Just remove my files
			Remove files and clean the drive
	All drives		Just remove my files
		Remove files and clean the drive	

► Keep my files

1. Select [Keep my files].

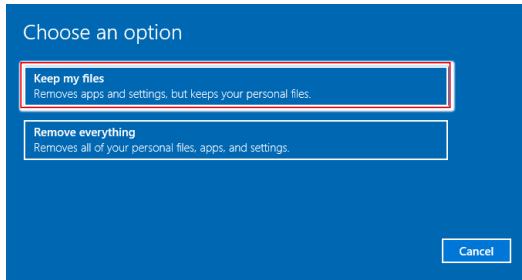

2. The [Your apps will be removed] screen shows a list of apps that will need to be reinstalled from the web or installation discs. Click [Next] to continue.

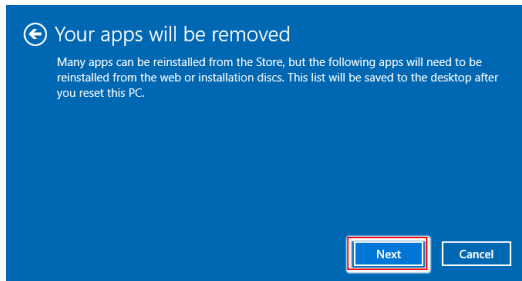

3. The next screen will show the changes to be made during the process. Click [Reset] to start the system reset.

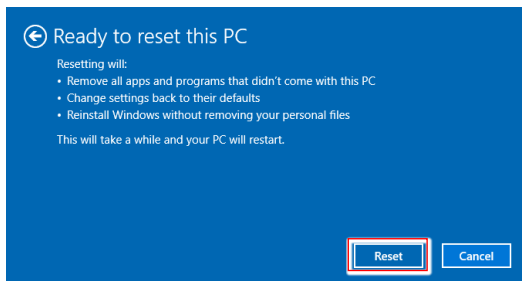

► Remove everything

1. Select [Remove everything].

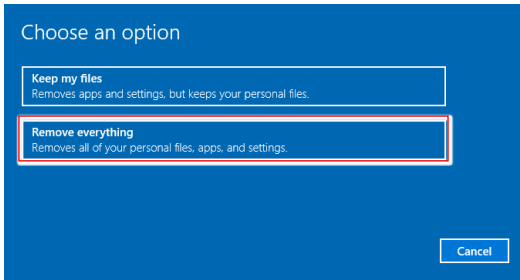

2. If you have multiple hard drives, a screen will pop up, asking you to choose between [Only the drive where Windows is installed] and [All drives].

3. Then select between [Just remove my files] and [Remove files and clean the drive].

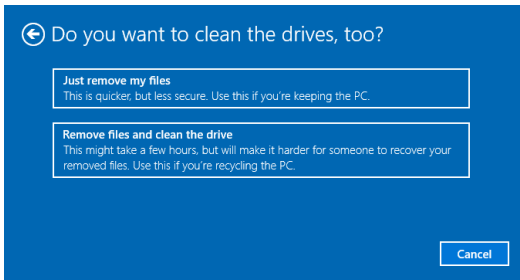

4. The next screen will show the changes to be made during the process. Click [Reset] to start the system reset.

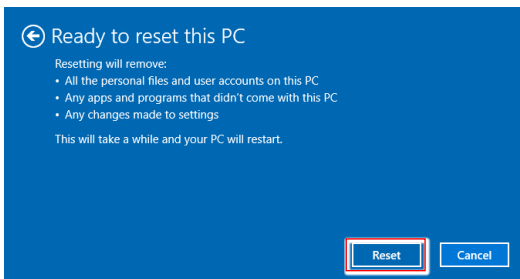

System Recovery (F3 Hotkey Recovery) (Optional)

► Precautions for Using the System Recovery Function

1. If your hard drive and system encountered non-recoverable problems, please use the F3 Hotkey recovery from the Hard Drive first to perform the System Recover Function.
2. Before using the System Recovery Function, please backup the important data saved on your system drive to other storage devices.

► Recovering the system with the F3 Hotkey

Follow the instructions below to continue:

1. Restart the PC.
2. Press the F3 hotkey on the keyboard promptly when the MSI greeting appears on the display.
3. On the “Choose an Option” screen, tap “Troubleshoot”.
4. On the “Troubleshoot” screen, tap “Restore MSI factory” to reset the system to the default settings.
5. On the “RECOVERY SYSTEM” screen, tap “System Partition Recovery”.
6. Follow the on-screen instructions to continue and complete the Recovery Function.

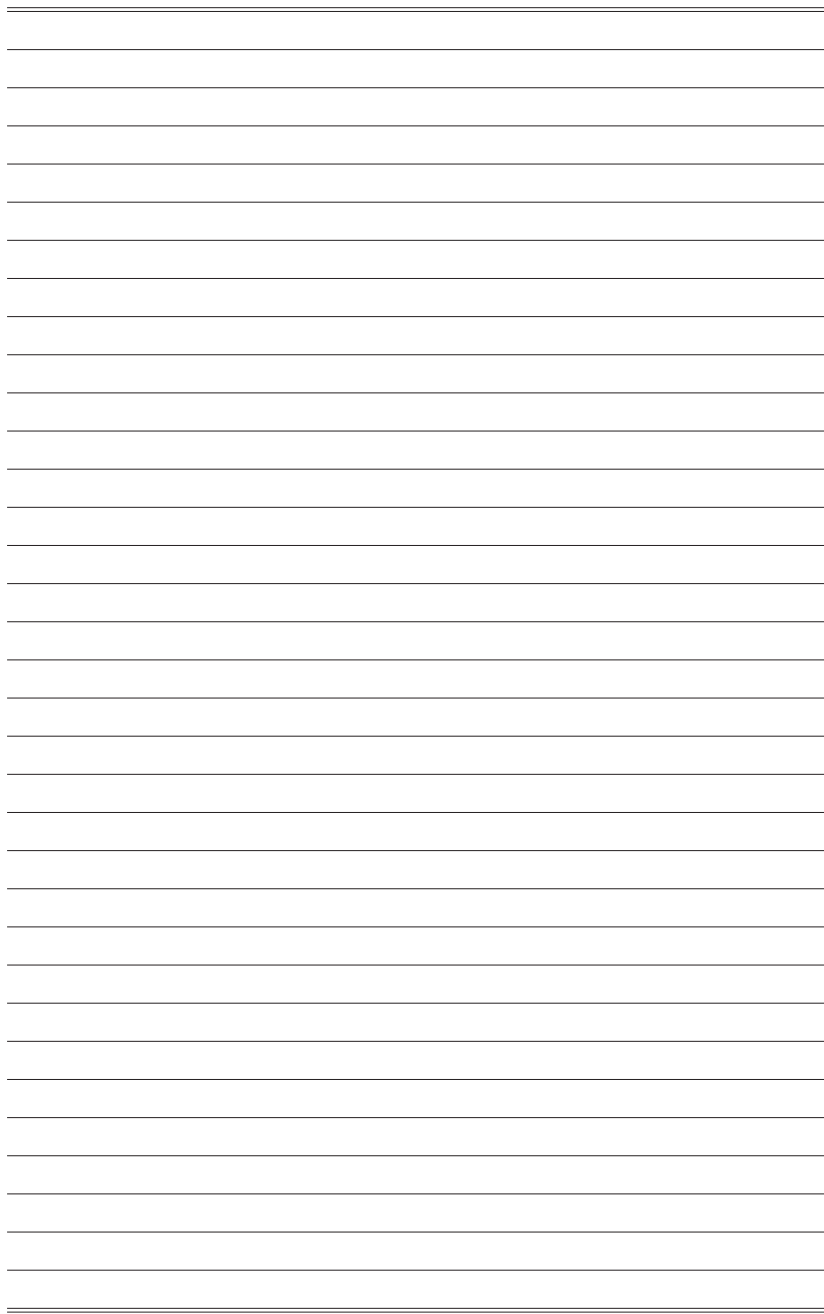

A

Troubleshooting

My system does not start.

1. Check if the system is connected to an electrical outlet and it is turned on.
2. Check if the power cord and all cables are connected firmly.

When I turn on my computer, the message “Operating System not found” appears or Windows does not start.

1. Check if there is a non-bootable CD/ DVD inside the optical disk drive. If so, remove the CD/ DVD then restart the computer.
2. Check Boot Device Priority settings in the BIOS Setup.

The system can not be shut down.

It is best to shut down your computer using the Shut Down icon in the operating system. Using other methods, including those listed below, may result in data failure. If the Shut Down procedure does not work, choose one of the following steps:

1. Press Ctrl+Alt+Del keys, then choose Shut Down.
2. Press and hold the power button till the system is off.
3. Unplug the power cable from the system.

My microphone does not work.

1. For built-in microphone, please go to Start > Control Panel > Sounds and Audio Devices > Audio to check if it is muted.
2. If you are using an external microphone, check that the microphone is plugged into the Microphone jack.

The Internet connection has problems.

1. If you are having a problem connecting to your Internet Service Provider (ISP), check if the ISP is experiencing technical problems.
2. Check the Network settings and connection and make sure the system is properly configured to Internet access.
3. The wireless LAN data transfer speed is affected by distance and obstructions between devices and access points. To maximize the data transfer speed, choose the access point closest to your system.

System speakers do not work.

1. Check the master volume setting in the Audio Mixer.
2. If you are using an application that has its own volume control, check if the volume is muted.
3. If you have connected an audio cable to the Headphone jack, disconnect it.
4. If the system has OSD function, please adjust the volume of OSD.

System monitor does not display anything.

1. Check if the system is connected to an electrical outlet and it is turned on.
2. The system may be in Standby mode. Press any key to activate the Display.