

**TUF Z390M-PRO
GAMING (Wi-Fi)**

ASUS®

Motherboard

E14630
First Edition
August 2018

Copyright© 2018 ASUSTeK COMPUTER INC. All Rights Reserved.

No part of this manual, including the products and software described in it, may be reproduced, transmitted, transcribed, stored in a retrieval system, or translated into any language in any form or by any means, except documentation kept by the purchaser for backup purposes, without the express written permission of ASUSTeK COMPUTER INC. ("ASUS").

Product warranty or service will not be extended if: (1) the product is repaired, modified or altered, unless such repair, modification of alteration is authorized in writing by ASUS; or (2) the serial number of the product is defaced or missing.

ASUS PROVIDES THIS MANUAL "AS IS" WITHOUT WARRANTY OF ANY KIND, EITHER EXPRESS OR IMPLIED, INCLUDING BUT NOT LIMITED TO THE IMPLIED WARRANTIES OR CONDITIONS OF MERCHANTABILITY OR FITNESS FOR A PARTICULAR PURPOSE. IN NO EVENT SHALL ASUS, ITS DIRECTORS, OFFICERS, EMPLOYEES OR AGENTS BE LIABLE FOR ANY INDIRECT, SPECIAL, INCIDENTAL, OR CONSEQUENTIAL DAMAGES (INCLUDING DAMAGES FOR LOSS OF PROFITS, LOSS OF BUSINESS, LOSS OF USE OR DATA, INTERRUPTION OF BUSINESS AND THE LIKE), EVEN IF ASUS HAS BEEN ADVISED OF THE POSSIBILITY OF SUCH DAMAGES ARISING FROM ANY DEFECT OR ERROR IN THIS MANUAL OR PRODUCT.

SPECIFICATIONS AND INFORMATION CONTAINED IN THIS MANUAL ARE FURNISHED FOR INFORMATIONAL USE ONLY, AND ARE SUBJECT TO CHANGE AT ANY TIME WITHOUT NOTICE, AND SHOULD NOT BE CONSTRUED AS A COMMITMENT BY ASUS. ASUS ASSUMES NO RESPONSIBILITY OR LIABILITY FOR ANY ERRORS OR INACCURACIES THAT MAY APPEAR IN THIS MANUAL, INCLUDING THE PRODUCTS AND SOFTWARE DESCRIBED IN IT.

Products and corporate names appearing in this manual may or may not be registered trademarks or copyrights of their respective companies, and are used only for identification or explanation and to the owners' benefit, without intent to infringe.

Offer to Provide Source Code of Certain Software

This product contains copyrighted software that is licensed under the General Public License ("GPL"), under the Lesser General Public License Version ("LGPL") and/or other Free Open Source Software Licenses. Such software in this product is distributed without any warranty to the extent permitted by the applicable law. Copies of these licenses are included in this product.

Where the applicable license entitles you to the source code of such software and/or other additional data, you may obtain it for a period of three years after our last shipment of the product, either

(1) for free by downloading it from <https://www.asus.com/support/>

or

(2) for the cost of reproduction and shipment, which is dependent on the preferred carrier and the location where you want to have it shipped to, by sending a request to:

ASUSTeK Computer Inc.
Legal Compliance Dept.
15 Li Te Rd.,
Beitou, Taipei 112
Taiwan

In your request please provide the name, model number and version, as stated in the About Box of the product for which you wish to obtain the corresponding source code and your contact details so that we can coordinate the terms and cost of shipment with you.

The source code will be distributed WITHOUT ANY WARRANTY and licensed under the same license as the corresponding binary/object code.

This offer is valid to anyone in receipt of this information.

ASUSTeK is eager to duly provide complete source code as required under various Free Open Source Software licenses. If however you encounter any problems in obtaining the full corresponding source code we would be much obliged if you give us a notification to the email address gpl@asus.com, stating the product and describing the problem (please DO NOT send large attachments such as source code archives, etc. to this email address).

Contents

| | |
|-----------------------------------------------------------|------|
| Safety information..... | vi |
| About this guide..... | vii |
| TUF Z390M-PRO GAMING (Wi-Fi) specifications summary | ix |
| Package contents..... | xiii |
| Installation tools and components..... | xiv |

Chapter 1: Product Introduction

| | | |
|------------|-------------------------------------|------------|
| 1.1 | Motherboard overview..... | 1-1 |
| 1.1.1 | Before you proceed..... | 1-1 |
| 1.1.2 | Motherboard layout..... | 1-2 |
| 1.1.3 | Central Processing Unit (CPU) | 1-4 |
| 1.1.4 | System memory | 1-5 |
| 1.1.5 | Expansion slots..... | 1-7 |
| 1.1.6 | Onboard switches | 1-9 |
| 1.1.7 | Jumpers | 1-10 |
| 1.1.8 | Onboard LEDs | 1-11 |
| 1.1.9 | Internal connectors..... | 1-12 |

Chapter 2: Basic Installation

| | | |
|------------|-----------------------------------------------------|-------------|
| 2.1 | Building your PC system..... | 2-1 |
| 2.1.1 | CPU installation..... | 2-1 |
| 2.1.2 | Cooling system installation..... | 2-3 |
| 2.1.3 | Motherboard installation..... | 2-4 |
| 2.1.4 | DIMM installation..... | 2-5 |
| 2.1.5 | ATX power connection | 2-6 |
| 2.1.6 | SATA device connection | 2-7 |
| 2.1.7 | Front I/O connector | 2-8 |
| 2.1.8 | Expansion card installation | 2-9 |
| 2.1.9 | M.2 installation | 2-10 |
| 2.1.10 | Wi-Fi antenna installation..... | 2-11 |
| 2.2 | Motherboard rear and audio connections | 2-12 |
| 2.2.1 | Rear I/O connection | 2-12 |
| 2.2.2 | Audio I/O connections | 2-14 |
| 2.3 | Starting up for the first time..... | 2-15 |
| 2.4 | Turning off the computer | 2-15 |

Chapter 3: BIOS Setup

| | | |
|-------------|---------------------------------------|-------------|
| 3.1 | Knowing BIOS | 3-1 |
| 3.2 | BIOS setup program | 3-2 |
| 3.2.1 | EZ Mode..... | 3-3 |
| 3.2.2 | Advanced Mode | 3-4 |
| 3.2.3 | QFan Control..... | 3-7 |
| 3.2.4 | EZ Tuning Wizard | 3-9 |
| 3.3 | My Favorites | 3-12 |
| 3.4 | Main menu | 3-14 |
| 3.5 | Ai Tweaker menu | 3-14 |
| 3.6 | Advanced menu | 3-16 |
| 3.6.1 | Platform Misc Configuration..... | 3-16 |
| 3.6.2 | CPU Configuration | 3-16 |
| 3.6.3 | System Agent (SA) Configuration | 3-16 |
| 3.6.4 | PCH Configuration | 3-17 |
| 3.6.5 | PCH Storage Configuration..... | 3-17 |
| 3.6.6 | PCH-FW Configuration | 3-18 |
| 3.6.7 | Onboard Devices Configuration..... | 3-18 |
| 3.6.8 | APM Configuration | 3-18 |
| 3.6.9 | PCI Subsystem Settings | 3-18 |
| 3.6.10 | USB Configuration | 3-19 |
| 3.6.11 | Network Stack Configuration..... | 3-19 |
| 3.6.12 | NVMe Configuration..... | 3-19 |
| 3.6.13 | HDD/SSD SMART Information | 3-19 |
| 3.7 | Monitor menu | 3-20 |
| 3.8 | Boot menu | 3-20 |
| 3.9 | Tool menu | 3-22 |
| 3.9.1 | ASUS EZ Flash 3 Utility | 3-22 |
| 3.9.2 | ASUS User Profile..... | 3-22 |
| 3.9.3 | ASUS SPD Information | 3-22 |
| 3.9.4 | ASUS Q-Installer..... | 3-22 |
| 3.10 | Exit menu | 3-23 |
| 3.11 | Updating BIOS | 3-24 |
| 3.11.1 | EZ Update | 3-24 |
| 3.11.2 | ASUS EZ Flash 3..... | 3-25 |
| 3.11.3 | ASUS CrashFree BIOS 3..... | 3-27 |

Chapter 4: RAID Support

4.1 RAID configurations 4-1
 4.1.1 RAID definitions 4-1

Appendix

Notices A-1
ASUS contact information..... A-7

Safety information

Electrical safety

- To prevent electrical shock hazard, disconnect the power cable from the electrical outlet before relocating the system.
- When adding or removing devices to or from the system, ensure that the power cables for the devices are unplugged before the signal cables are connected. If possible, disconnect all power cables from the existing system before you add a device.
- Before connecting or removing signal cables from the motherboard, ensure that all power cables are unplugged.
- Seek professional assistance before using an adapter or extension cord. These devices could interrupt the grounding circuit.
- Ensure that your power supply is set to the correct voltage in your area. If you are not sure about the voltage of the electrical outlet you are using, contact your local power company.
- If the power supply is broken, do not try to fix it by yourself. Contact a qualified service technician or your retailer.

Operation safety

- Before installing the motherboard and adding devices on it, carefully read all the manuals that came with the package.
- Before using the product, ensure all cables are correctly connected and the power cables are not damaged. If you detect any damage, contact your dealer immediately.
- To avoid short circuits, keep paper clips, screws, and staples away from connectors, slots, sockets and circuitry.
- Avoid dust, humidity, and temperature extremes. Do not place the product in any area where it may become wet.
- Place the product on a stable surface.
- If you encounter technical problems with the product, contact a qualified service technician or your retailer.

About this guide

This user guide contains the information you need when installing and configuring the motherboard.

How this guide is organized

This guide contains the following parts:

1. Chapter 1: Product Introduction

This chapter describes the features of the motherboard and the new technology it supports. It includes description of the switches, jumpers, and connectors on the motherboard.

2. Chapter 2: Basic Installation

This chapter lists the hardware setup procedures that you have to perform when installing system components.

3. Chapter 3: BIOS Setup

This chapter tells how to change system settings through the BIOS Setup menus. Detailed descriptions of the BIOS parameters are also provided.

4. Chapter 4: RAID Support

This chapter describes the RAID configurations.

Where to find more information

Refer to the following sources for additional information and for product and software updates.

1. ASUS website

The ASUS website (www.asus.com) provides updated information on ASUS hardware and software products.

2. Optional documentation

Your product package may include optional documentation, such as warranty flyers, that may have been added by your dealer. These documents are not part of the standard package.

Conventions used in this guide

To ensure that you perform certain tasks properly, take note of the following symbols used throughout this manual.



DANGER/WARNING: Information to prevent injury to yourself when trying to complete a task.



CAUTION: Information to prevent damage to the components when trying to complete a task.



IMPORTANT: Instructions that you *MUST* follow to complete a task.



NOTE: Tips and additional information to help you complete a task.

Typography

Bold text

Indicates a menu or an item to select.

Italics

Used to emphasize a word or a phrase.

<Key>

Keys enclosed in the less-than and greater-than sign means that you must press the enclosed key.

Example: <Enter> means that you must press the Enter or Return key.

<Key1> + <Key2> + <Key3>

If you must press two or more keys simultaneously, the key names are linked with a plus sign (+).

TUF Z390M-PRO GAMING (Wi-Fi) specifications summary

| | |
|---------------------------------|----------------------------------------------------------------------------------------------------------------------------------------------------------------------------------------------------------------------------------------------------------------------------------------------------------------------------------------------------------------------------------------------------------------------------------------------------------------------------------------------------------------------------------------------------------------------------------------------|
| <p>CPU</p> | <p>Intel® Socket 1151 for Intel® Core™ 9000 series, 8th Generation Core™ i7/ i5/ i3, Pentium® and Celeron® processors</p> <p>Supports 14nm CPU</p> <p>Supports Intel® Turbo Boost Technology 2.0*</p> <p>* Intel® Turbo Boost Technology 2.0 support depends on the CPU types.</p> <p>** Refer to www.asus.com for Intel® CPU support list.</p> |
| <p>Chipset</p> | <p>Intel® Z390 Chipset</p> |
| <p>Memory</p> | <p>4 x DIMM, max. 64GB, DDR4 4133(O.C.) / 4000(O.C.) / 3866(O.C.) / 3733(O.C.) / 3600(O.C.) / 3466(O.C.) / 3400(O.C.) / 3333(O.C.) / 3300(O.C.) / 3200(O.C.) / 3000(O.C.) / 2800(O.C.) / 2666 / 2400 / 2133 MHz, non-ECC, un-buffered memory</p> <p>Dual channel memory architecture</p> <p>Supports Intel® Extreme Memory Profile (XMP)</p> <p>* Hyper DIMM support is subject to the physical characteristics of individual CPUs. Please refer to Memory QVL(Qualified Vendors List) for details.</p> <p>** For DRAM compatibility and performance, please use A2 slot for priority 1.</p> |
| <p>Expansion slots</p> | <p>2 x PCIe 3.0 / 2.0 x16 slots (support x16, x8/x8, x8/x4+x4*, x8+x4+x4+x0**)</p> <p>1 x PCIe 3.0 / 2.0 x1 slot</p> <p>* For 2 Intel® SSD on CPU support, install a Hyper M.2 X16 card (sold separately) into the PCIe X16_2 slot, and enable this card under BIOS settings.</p> <p>** For 3 Intel® SSD on CPU support, install a Hyper M.2 X16 card (sold separately) into the PCIe X16_1 slot, and enable this card under BIOS settings.</p> <p>*** Hyper M.2 X16 series card is sold separately. Install a Hyper M.2 X16 series card and enable this card under BIOS settings.</p> |
| <p>Multi-GPU Support</p> | <p>Supports NVIDIA® 2-Way SLI™ Technology</p> <p>Supports AMD® 2-Way/Quad-GPU CrossFireX™ Technology</p> |
| <p>VGA</p> | <p>Integrated Graphics Processor- Intel® UHD Graphics support</p> <p>Multi-VGA output support: DisplayPort 1.2 */ HDMI ports</p> <ul style="list-style-type: none"> - Supports DisplayPort 1.2 output with a max. resolution of 4096 x 2304 @60Hz - Supports HDMI 1.4b output with a max. resolution of 4096 x 2160 @30Hz - Supports Intel® InTru™ 3D, Quick Sync Video, Clear Video HD Technology, Insider™ <p>* DP 1.2 Multi-Stream Transport compliant supports DP 1.2 monitor daisy chain up to 3 displays</p> |
| <p>Storage</p> | <p>Intel® CPU support with Intel® Rapid Storage Technology (RAID0 & RAID 1)</p> <ul style="list-style-type: none"> - Supports CPU RAID with Intel® PCIe NVME SSDs. PCIEX16_1 slot and PCIEX16_2 slot can support RAID 0 and 1. RAID 0 and 1 are also supported via a Hyper M.2 X16 series card. - PCIEX16_1 slot supports up to 3 Intel® PCIe NVME SSDs via a Hyper M.2 X16 series card.* - PCIEX16_2 slot supports up to 2 Intel® PCIe NVME SSDs via a Hyper M.2 X16 series card.* |

(continued on the next page)

TUF Z390M-PRO GAMING (Wi-Fi) specifications summary

| | |
|-----------------------|-------------------------------------------------------------------------------------------------------------------------------------------------------------------------------------------------------------------------------------------------------------------------------------------------------------------------------------------------------------------------------------------------------------------------------------------------------------------------------------------------------------------------------------------------------------------------------------------------------------------------------------------------------------------------------------------------------------------------------|
| Storage | <p>Intel® Z390 Chipset with RAID 0, 1, 5, 10 and Intel Rapid Storage Technology support</p> <ul style="list-style-type: none"> - 1 x M.2_1 Socket 3 with M key, type 2242/2260/2280/22110 storage devices support (both PCIe x4 & SATA modes)** - 1 x M.2_2 Socket 3 with M Key, type 2242/2260/2280 storage devices support (PCIe x4 mode) - 6 x SATA 6Gb/s ports - Intel® Optane™ Memory Ready <p>* Hyper M.2 X16 series card is sold separately. Install a Hyper M.2 X16 series card and enable this card under BIOS settings.</p> <p>** The M.2_1 socket shares SATA_2 port when using M.2 SATA mode device. Adjust BIOS settings to use a SATA device.</p> |
| LAN | <p>Intel® I219V Dual interconnect between the integrated Media Access Controller (MAC) and Physical Layer (PHY)</p> <p>TUF LANGuard</p> <p>ASUS Turbo LAN Utility</p> |
| Wireless Data Network | <p>Intel® Wireless-AC 9560</p> <p>Intel® CNVi interface with Wi-Fi MU-MIMO 802.11 a/b/g/n/ac supports dual frequency band 2.4/5 GHz</p> <p>Supports channel bandwidth: HT20/HT40/HT80/HT160, Up to 1.73Gbps transfer speed</p> |
| Bluetooth | <p>Bluetooth V5.0*</p> <p>* Bluetooth V5.0 will be supported on future versions of Windows. Refer to https:// www.microsoft.com for updates on Windows OS Bluetooth support version.</p> |
| Audio | <p>Realtek® S1200A 8-Channel* High Definition Audio CODEC</p> <ul style="list-style-type: none"> - DTS Custom for TUF GAMING Headphone - Audio Shielding: Ensures precision analog/digital separation and greatly reduces multi-lateral interference - Dedicated audio PCB layers: Separate layers for left and right channels to guard the quality of the sensitive audio signals - Premium Japanese audio capacitors: Provide warm, natural and immersive sound with exceptional clarity and fidelity - Supports jack-detection and front panel jack-retasking <p>* Choose the chassis with HD audio module in front panel to support 8-channel audio output.</p> |
| USB | <p>Intel® Z390 Chipset:</p> <ul style="list-style-type: none"> - 2 x USB 3.1 Gen 2 (up to 10Gbps) ports (1 port at mid-board; 1 port at back panel, [teal blue], Type A) - 7 x USB 3.1 Gen 1 ports (2 ports at mid-board; 4 ports at back panel, [blue], Type A; 1 port at back panel, Type C) - 4 x USB 2.0 ports (4 ports at mid-board) |

(continued on the next page)

TUF Z390M-PRO GAMING (Wi-Fi) specifications summary

| | |
|---------------------------------------|-----------------------------------------------------------------------------------------------------------------------------------------------------------------------------------------------------------------------------------------------------------------------------------------------------------------------------------------------------------------------------------------------------------------------------------------------------------------------------------------------------------------------------------------------------------------------------------------------------------------------------------------------------------------------------------------------------------------------------------------------------------------------------------------------------------------------------------------------------------------------------------------------------------------------------------------------------------------------------------------------------------------------------------------------------------------------------------------------------------------------------------------------------------------------------------------------------------------------------------------------------------------------------------------------------|
| <p>Back I/O Ports</p> | <p>1 x PS/2 keyboard port 1 x PS/2 mouse port 1 x HDMI port 1 x DisplayPort 1 x USB3.1 Gen 2 (up to 10Gbps) port (Type A [teal blue]) 1 x USB3.1 Gen 1 port (Type C) 4 x USB3.1 Gen 1 ports (Type A [blue]) 1 x LAN (RJ45) port 1 x Intel® Wi-Fi module 3 x Audio jacks</p> |
| <p>Internal I/O connectors</p> | <p>1 x USB 3.1 Gen 2 (up to 10Gbps) front panel connector 1 x USB 3.1 Gen 1 connector supports additional 2 USB 3.1 Gen 1 ports (19-pin) 2 x USB 2.0 connectors support additional 4 USB 2.0 ports 6 x SATA 6Gb/s connectors 1 x M.2_1 Socket 3 for M Key, type 2242/2260/2280/22110 storage devices 1 x M.2_2 Socket 3 for M Key, type 2242/2260/2280 storage devices 1 x 4-Pin CPU fan connector for both 3-pin (DC mode) and 4-pin (PWM mode) CPU coolers control* 1 x 4-Pin CPU_OPT connector 1 x 4-Pin AIO_Pump header 2 x 4-Pin Chassis fan connectors for both 3-pin (DC mode) and 4-pin (PWM mode) coolers control* 1 x Front panel audio connector (AAFP) 1 x 24-Pin EATX power connector 1 x 8-Pin EATX 12V power connector 1 x System Panel (Q-Connector) 1 x COM port 2 x RGB Strip headers 1 x S/PDIF out header 1 x MemOK!_II switch 1 x Clear CMOS jumper</p> <p>* By default, the CPU/Chassis Q-Fan control setting is set to Auto mode, which detects the CPU and chassis fans installed and changes the control mode automatically.</p> |
| <p>ASUS Special Features</p> | <p>TUF Components (TUF Cap, TUF Chokes, MOSFET & LANGuard ; certified by military-standard)</p> <p>ASUS TUF PROTECTION</p> <ul style="list-style-type: none"> - ASUS SafeSlot: Protects your graphics card Investment - ASUS ESD Guard: Enhanced ESD protection - ASUS Overvoltage Protection: World-class circuit-protecting power design - ASUS Stainless-Steel Back I/O: 3X corrosion-resistance for greater durability! - ASUS DIGI+ VRM: 8+1 Phase digital power design |

(continued on the next page)

TUF Z390M-PRO GAMING (Wi-Fi) specifications summary

| | | |
|------------------------------------|-----------------------------------------------------------------------------------------------------------------------------------------------|------------------------------------------------------------------------------------------------------------------------------------------------------------------------------------------------------------------------------------------------------------------------------------------------|
| ASUS Special Features | Superb Performance | |
| | Turbo LAN - Experience smooth online gaming with lower pings and less lags | |
| | M.2 onboard - The latest transfer technologies with up to 32Gb/s data transfer speeds | |
| | ASUS Fan Xpert 4 - Advanced fan and liquid controls for ultimate cooling and quietness | |
| | ASUS EPU - EPU | |
| | OptiMem II - Higher performance of memory overclocking. Enhance compatibility for some memory with RGB. | |
| | MemOK! II - Enhance memory compatibility. More smart and convenient. Keep high performance. (Shorten the PC starting time) | |
| | Q-Installer - Auto download driver and software. Friendly for first PC builder. | |
| | AURA - Bright up your Build | |
| | ASUS Exclusive Features - ASUS Ai Charger - ASUS AI Suite 3 | |
| ASUS Quiet Thermal Solution | ASUS EZ DIY | |
| | EZ Update | |
| | UEFI BIOS EZ Mode - Featuring friendly graphics user interface - ASUS O.C. Tuner - ASUS CrashFree BIOS 3 - ASUS EZ Flash 3 | |
| | PC Cleaner | |
| | ASUS Q-Design - ASUS Q-Connector - ASUS Q-Slot - ASUS Q-DIMM | |
| | - ASUS ASUS Fan Xpert 4 - Stylish Fanless Design: PCH Heat-sink & 2 x MOS Heat-sink & M.2 Heat-sink solution | |
| | BIOS Features | 128 Mb Flash ROM, UEFI AMI BIOS, PnP, DMI3.0, WfM2.0, SM BIOS 3.0, ACPI 6.0, Multi-language BIOS, ASUS EZ Flash 3, CrashFree BIOS 3, F11 EZ Tuning Wizard, F6 Qfan Control, F3 My Favorites, Last Modified log, F12 PrintScreen, and ASUS DRAM SPD (Serial Presence Detect) memory information |

(continued on the next page)

TUF Z390M-PRO GAMING (Wi-Fi) specifications summary

| | |
|---------------------------------|----------------------------------------------------------------------------------|
| Manageability | WOL by PME, PXE |
| Support DVD contents | Drivers ASUS Utilities ASUS EZ Update Anti-virus software (OEM version) |
| Operating system support | Windows® 10 64-bit |
| Form factor | mATX Form Factor, 9.6"x 9.6" (24.4cm x 24.4cm) |



Specifications are subject to change without notice. Please refer to the ASUS website for the latest specifications.

Package contents

Check your motherboard package for the following items.

| | |
|-------------------|---------------------------------------------------------------------------------|
| Motherboard | TUF Z390M-PRO GAMING (Wi-Fi) |
| Cables | 2 x SATA 6Gb/s cables |
| Accessories | 1 x IO Shield |
| | 1 x M.2 screw package (2-in-1) |
| | 1 x Q-connector |
| | 1 x SLI™ HB BRIDGE (2-WAY-S) |
| Application drive | 1 x ASUS 2T2R dual band Wi-Fi moving antenna (Wi-Fi 802.11a/b/g/n/ac compliant) |
| | 1 x TUF GAMING sticker |
| Documentation | 1 x User guide |
| | 1 x TUF Certification card |



If any of the above items is damaged or missing, contact your retailer.

Installation tools and components

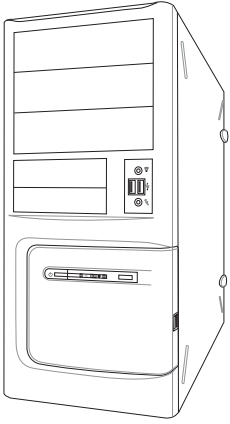

PC chassis

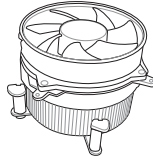

Intel® 1151 compatible CPU Fan

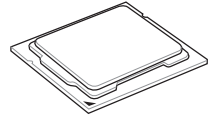

Intel® 1151 CPU

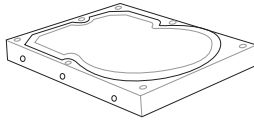

SATA hard disk drive



Phillips (cross) screwdriver

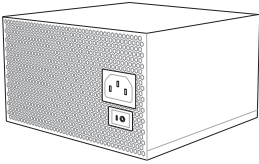

Power supply unit

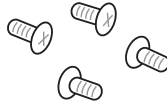

1 bag of screws

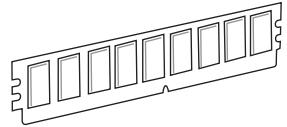

DIMM

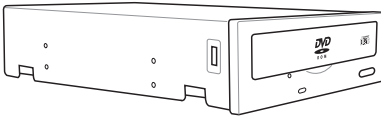

SATA optical disc drive (optional)

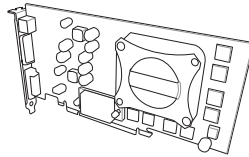

Graphics card



The tools and components listed above are not included in the motherboard package.

Product Introduction

1

1.1 Motherboard overview

1.1.1 Before you proceed

Take note of the following precautions before you install motherboard components or change any motherboard settings.



-
- Unplug the power cord from the wall socket before touching any component.
 - Before handling components, use a grounded wrist strap or touch a safely grounded object or a metal object, such as the power supply case, to avoid damaging them due to static electricity.
 - Hold components by the edges to avoid touching the ICs on them.
 - Whenever you uninstall any component, place it on a grounded antistatic pad or in the bag that came with the component.
 - Before you install or remove any component, ensure that the ATX power supply is switched off or the power cord is detached from the power supply. Failure to do so may cause severe damage to the motherboard, peripherals, or components.
-

1.1.2 Motherboard layout

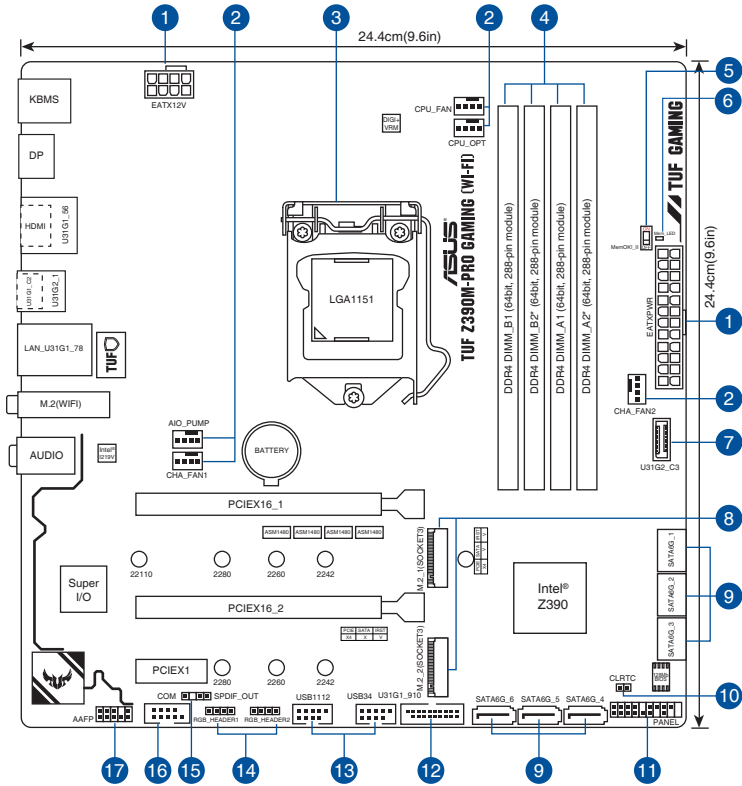

Refer to **1.1.9 Internal connectors** and **2.2.1 Rear I/O connection** for more information about rear panel connectors and internal connectors.

Layout contents

| Connectors/Jumpers/Buttons and switches/Slots | Page |
|---------------------------------------------------------------------------------------------------------------------------------------|------|
| 1. EATX power connectors (24-pin EATXPWR; 8-pin EATX12V) | 1-16 |
| 2. CPU, CPU optional, and chassis fan connectors; AIO pump connector (4-pin CPU_FAN; 4-pin CPU_OPT; 4-pin CHA_FAN1-2; 4-pin AIO_PUMP) | 1-15 |
| 3. LGA1151 CPU socket | 1-4 |
| 4. DDR4 DIMM slots | 1-5 |
| 5. MemOK! II switch (MemOK!_II_switch) | 1-9 |
| 6. Memory LED (Mem_LED) | 1-11 |
| 7. USB 3.1 Gen 2 front panel connector (U31G2_C3) | 1-13 |
| 8. M.2 sockets (M.2_1; M.2_2) | 1-18 |
| 9. Intel® Serial ATA 6 Gb/s connectors (7-pin SATA6G_1-6) | 1-12 |
| 10. Clear RTC RAM jumper (2-pin CLRTC) | 1-10 |
| 11. System panel connector (20-5 pin PANEL) | 1-17 |
| 12. USB 3.1 Gen 1 connector (20-1 pin U31G1_910) | 1-14 |
| 13. USB 2.0 connectors (10-1 pin USB1112, USB34) | 1-14 |
| 14. RGB headers (4-pin RGB_HEADER_1/2) | 1-19 |
| 15. Digital audio connector (4-1 pin SPDIF_OUT) | 1-18 |
| 16. Serial port connector (10-1 pin COM) | 1-15 |
| 17. Front panel audio connector (10-1 pin AAFP) | 1-13 |

1.1.3 Central Processing Unit (CPU)

The motherboard comes with a surface mount LGA1151 socket designed for Intel® Core™ 9000 series, 8th Generation Core™ i7/ i5/ i3, Pentium® and Celeron® processors.

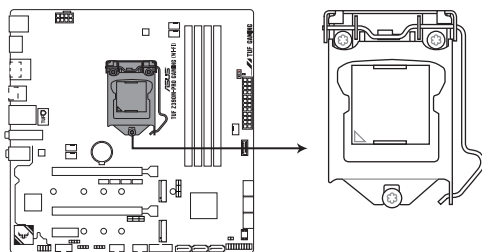

TUF Z390M-PRO GAMING (WI-FI) CPU LGA1151



- Ensure that you install the correct CPU designed for LGA1151 socket only. DO NOT install a CPU designed for LGA1150, LGA1155, and LGA1156 sockets in the LGA1151 socket.
- Ensure that all power cables are unplugged before installing the CPU.
- Upon purchase of the motherboard, ensure that the PnP cap is on the socket and the socket contacts are not bent. Contact your retailer immediately if the PnP cap is missing, or if you see any damage to the PnP cap/socket contacts/motherboard components. ASUS will shoulder the cost of repair only if the damage is shipment/transit-related.
- Keep the cap after installing the motherboard. ASUS will process Return Merchandise Authorization (RMA) requests only if the motherboard comes with the cap on the LGA1151 socket.
- The product warranty does not cover damage to the socket contacts resulting from incorrect CPU installation/removal, or misplacement/loss/incorrect removal of the PnP cap.

1.1.4 System memory

The motherboard comes with four DDR4 (Double Data Rate 4) Dual Inline Memory Modules (DIMM) slots.



A DDR4 module is notched differently from a DDR, DDR2, or DDR3 module. **DO NOT** install a DDR, DDR2, or DDR3 memory module to the DDR4 slot.

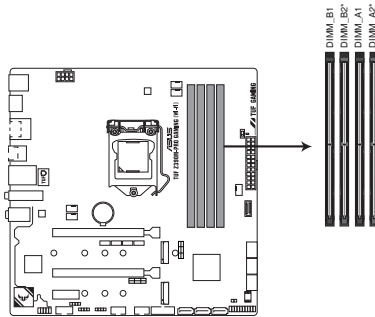

TUF Z390M-PRO GAMING (WI-FI)
288-pin DDR4 DIMM sockets

Recommended memory configurations

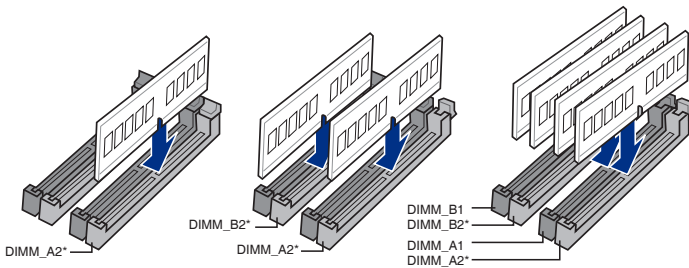

Memory configurations

You may install 2 GB, 4 GB, 8 GB and 16 GB unbuffered and non-ECC DDR4 DIMMs into the DIMM sockets.



You may install varying memory sizes in Channel A, and Channel B. The system maps the total size of the lower-sized channel for the dual-channel configuration. Any excess memory from the higher-sized channel is then mapped for single-channel operation.



- The default memory operation frequency is dependent on its Serial Presence Detect (SPD), which is the standard way of accessing information from a memory module. Under the default state, some memory modules for overclocking may operate at a lower frequency than the vendor-marked value.
 - For system stability, use a more efficient memory cooling system to support a full memory load (4 DIMMs) or overclocking condition.
 - Memory modules with memory frequency higher than 2133MHz and their corresponding timing or the loaded XMP profile is not the JEDEC memory standard. The stability and compatibility of the memory modules depend on the CPU's capabilities and other installed devices.
 - ASUS exclusively provides hyper DIMM support function.
 - Hyper DIMM support is subject to the physical characteristics of individual CPUs. Load the X.M.P. or D.O.C.P. settings in the BIOS for the hyper DIMM support.
 - Always install the DIMMS with the same CAS Latency. For an optimum compatibility, we recommend that you install memory modules of the same version or data code (D/C) from the same vendor. Check with the vendor to get the correct memory modules.
 - Visit the ASUS website for the latest QVL.
-

1.1.5 Expansion slots



Unplug the power cord before adding or removing expansion cards. Failure to do so may cause you physical injury and damage motherboard components.

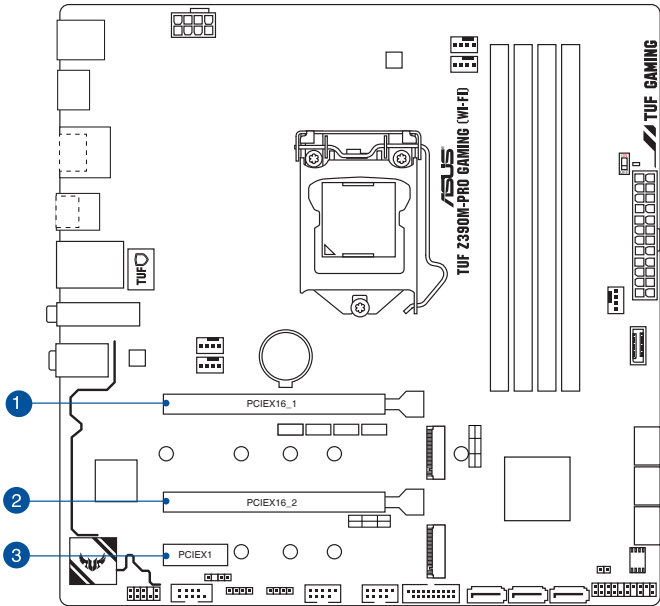

| Slot No. | Slot Description |
|----------|------------------|
| 1 | PCIEx16_1 slot |
| 2 | PCIEx16_2 slot |
| 3 | PCIEx1 slot |

| VGA Configuration | PCIe operating mode | |
|----------------------|---------------------------------|-----------|
| | PCIEX16_1 | PCIEX16_2 |
| Single VGA/PCIe card | x16 (single VGA recommended) | N/A |
| Dual VGA/PCIe cards | x8 | x8 |



- In single VGA card mode, use the PCIEX16_1 slot (gray) for a PCI Express x16 graphics card to get better performance.
- We recommend that you provide sufficient power when running CrossFireX™ or SLI™ mode.
- Connect a chassis fan to the motherboard connector labeled CHA_FAN1-2 when using multiple graphics cards for better thermal environment.

| Hyper M.2 X16 card configuration | PCI Express 3.0 operating mode | |
|----------------------------------|--------------------------------|-----------|
| | PCIEX16_1 | PCIEX16_2 |
| 2 Intel® SSD on CPU support | x8 | x4+x4 |
| 3 Intel® SSD on CPU support | x8+x4+x4 | N/A |



- Hyper M.2 X16 card is purchased separately.
- Enable the Hyper M.2 X16 card under BIOS settings.

1.1.6 Onboard switches

1. MemOK! II switch (MemOK!_II)

Installing DIMMs that are not compatible with the motherboard may cause system boot failure. The switch is enabled by default, allowing memory re-training when the motherboard is unresponsive due to memory problems. The Mem_LED will light up while re-training, and turn off when the re-training is complete.

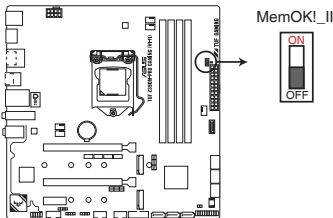

TUF Z390M-PRO GAMING (Wi-Fi) MemOK! switch



- Refer to section **1.1.8 Onboard LEDs** for the exact location of the MEM LED.
- The MemOK! II switch does not function under Windows® OS environment.
- During the tuning process, the system loads and tests pretest profiles. It takes about 30 seconds for the system to test one set of profiles. If the test fails, the system reboots and tests the next set of profiles. The system will reboot multiple times when training, once the system has completed the training process the Mem_LED will turn off, please refrain from doing anything before the Mem_LED turns off.
- Due to memory tuning requirement, the system automatically reboots when each profile is tested.
- If you turn off the computer and replace DIMMs during the tuning process, the system continues memory tuning after turning on the computer. To stop memory tuning, turn off the computer and unplug the power cord for about 5–10 seconds, then set the MemOK! II switch to disabled.
- Ensure to replace the DIMMs with ones recommended in the Memory QVL (Qualified Vendors Lists) at www.asus.com.
- We recommend that you download and update to the latest BIOS version from www.asus.com after using the MemOK! II function.

1.1.7 Jumpers

1. Clear RTC RAM jumper (2-pin CLRRTC)

This jumper allows you to clear the Real Time Clock (RTC) RAM in CMOS. You can clear the CMOS memory of date, time, and system setup parameters by erasing the CMOS RTC RAM data. The onboard button cell battery powers the RAM data in CMOS, which include system setup information such as system passwords.

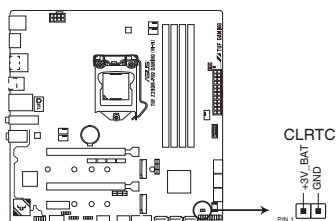

TUF Z390M-PRO GAMING (WI-FI) Clear RTC RAM

To erase the RTC RAM:

1. Turn OFF the computer and unplug the power cord.
2. Short-circuit pin 1-2 with a metal object or jumper cap for about 5-10 seconds.
3. Plug the power cord and turn ON the computer.
4. Hold down the <Delete> key during the boot process and enter BIOS setup to re-enter data.



Except when clearing the RTC RAM, never remove the cap on CLRRTC jumper default position. Removing the cap will cause system boot failure!



- If the steps above do not help, remove the onboard battery and move the jumper again to clear the CMOS RTC RAM data. After the CMOS clearance, reinstall the battery.
 - You do not need to clear the RTC when the system hangs due to overclocking. For system failure due to overclocking, use the C.P.R. (CPU Parameter Recall) feature. Shut down and reboot the system so the BIOS can automatically reset parameter settings to default values.
 - Due to the chipset behavior, AC power off is required to enable C.P.R. function. You must turn off and on the power supply or unplug and plug the power cord before rebooting the system.
-

1.1.8 Onboard LEDs

1. Memory LED (Mem_LED)

The Mem_LED will light up and remain lit while the MemOK! II function is in use. When the re-training is complete, the Mem_LED will turn off.

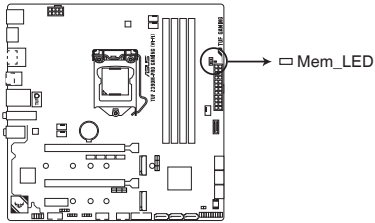

TUF Z390M-PRO GAMING (Wi-Fi) MemOK!_LED

1.1.9 Internal connectors

1. Intel® Z390 Serial ATA 6 Gb/s connectors (7-pin SATA6G_1-6)

These connectors connect to Serial ATA 6 Gb/s hard disk drives via Serial ATA 6 Gb/s signal cables.

If you installed Serial ATA hard disk drives, you can create a RAID 0, 1, 5, and 10 configuration with the Intel® Rapid Storage Technology through the onboard Intel® Z390 chipset.

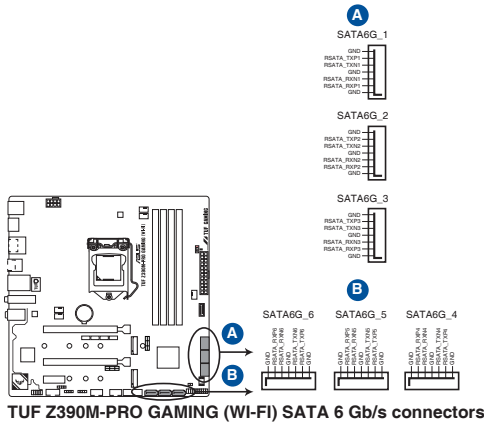

TUF Z390M-PRO GAMING (WI-FI) SATA 6 Gb/s connectors

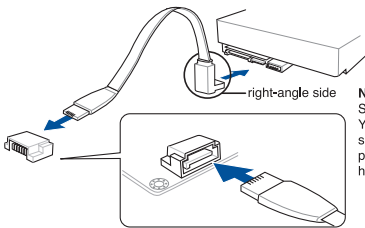

NOTE: Connect the right-angle side of SATA signal cable to SATA device. You may also connect the right-angle side of SATA cable to the onboard SATA port to avoid mechanical conflict with huge graphics cards.



- These connectors are set to **[AHCI]** by default. If you intend to create a Serial ATA RAID set using these connectors, set the SATA Mode item in the BIOS to **[Intel RST Premium With Intel Optane System Acceleration (RAID)]**.
- For more information on configuring your RAID sets, please refer to the **RAID Configuration Guide** which you can find at <https://www.asus.com/support>.
- The M.2_1 socket shares SATA_2 port when using an M.2 SATA mode device. Adjust BIOS settings to use a SATA device.

2. Front panel audio connector (10-1 pin AAFP)

This connector is for a chassis-mounted front panel audio I/O module that supports HD Audio. Connect one end of the front panel audio I/O module cable to this connector.

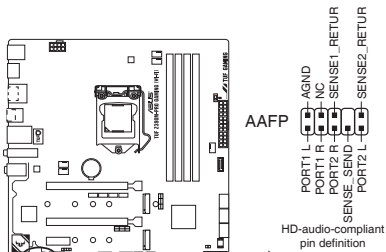

TUF Z390M-PRO GAMING (Wi-Fi) Analog front panel connector



We recommend that you connect a high-definition front panel audio module to this connector to avail of the motherboard's high-definition audio capability.

3. USB 3.1 Gen 2 front panel connector (U31G2_C3)

This connector allows you to connect a USB 3.1 Gen 2 module for additional USB 3.1 Gen 2 ports. The latest USB 3.1 Gen 2 connectivity provides data transfer speeds of up to 10 Gbps.

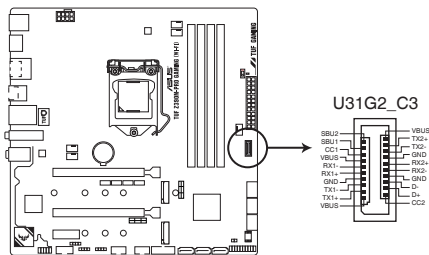

**TUF Z390M-PRO GAMING (Wi-Fi)
USB 3.1 Gen 2 front panel connector**



The USB 3.1 Gen 2 module is purchased separately.

4. USB 3.1 Gen1 connector (20-1 pin U31G1_910)

This connector allows you to connect a USB 3.1 Gen1 module for additional USB 3.1 Gen1 front or rear panel ports. With an installed USB 3.1 Gen1 module, you can enjoy all the benefits of USB 3.1 Gen1 including faster data transfer speeds of up to 5 Gb/s, faster charging time for USB-chargable devices, optimized power efficiency, and backward compatibility with USB 2.0.

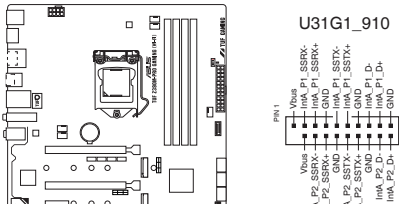

TUF Z390M-PRO GAMING (Wi-Fi) USB 3.1 Gen 1 connector



The USB 3.1 Gen1 module is purchased separately.

5. USB 2.0 connectors (10-1 pin USB1112, USB34)

These connectors are for USB 2.0 ports. Connect the USB module cable to these connectors, then install the module to a slot opening at the back of the system chassis. These USB connectors comply with USB 2.0 specification that supports up to 480 Mb/s connection speed.

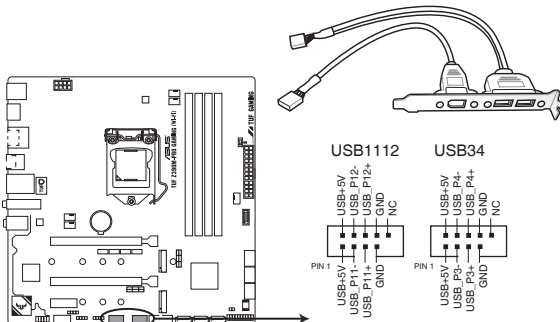

TUF Z390M-PRO GAMING (Wi-Fi) USB2.0 connectors



DO NOT connect a 1394 cable to the USB connectors. Doing so will damage the motherboard!



The USB 2.0 module is purchased separately.

6. CPU, CPU optional, and chassis fan connectors; AIO pump connector (4-pin CPU_FAN; 4-pin CPU_OPT; 4-pin CHA_FAN1-2; 4-pin AIO_PUMP)

Connect the fan cables to the fan connectors on the motherboard, ensuring that the black wire of each cable matches the ground pin of the connector.



- DO NOT forget to connect the fan cables to the fan connectors. Insufficient air flow inside the system may damage the motherboard components. These are not jumpers! Do not place jumper caps on the fan connectors!
- Ensure that the CPU fan cable is securely installed to the CPU fan connector.

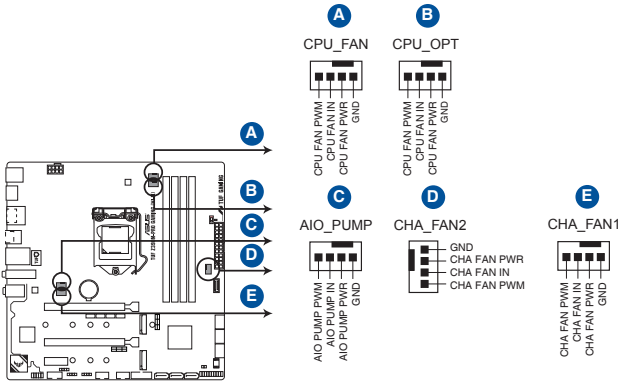

TUF Z390M-PRO GAMING (Wi-Fi) Fan connectors



- Connect the pump cable from the all-in-one cooler (AIO cooler) to the AIO_PUMP header, and connect the fan cables to the CPU_FAN and/or CPU_OPT header(s).
- If your AIO cooler has more than one fan, you may need to use a pigtail cable to connect the cooler to the motherboard.
- Ensure to fully insert the fan cable to the fan connector.

7. Serial port connector (10-1 pin COM)

This connector is for a serial (COM) port. Connect the serial port module cable to this connector, then install the module to a slot opening at the back of the system chassis.

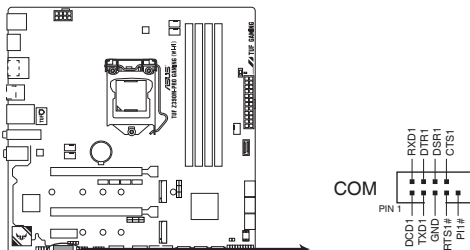

TUF Z390M-PRO GAMING (Wi-Fi) Serial port connector



The COM module is purchased separately.

8. EATX power connectors (24-pin EATXPWR; 8-pin EATX12V)

These connectors are for ATX power supply plugs. The power supply plugs are designed to fit these connectors in only one orientation. Find the proper orientation and push down firmly until the connectors completely fit.

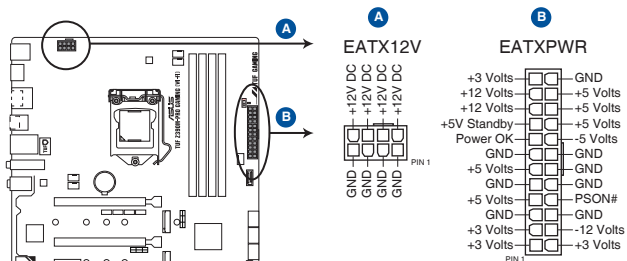

TUF Z390M-PRO GAMING (WI-FI) EATX power connectors



- For a fully configured system, we recommend that you use a power supply unit (PSU) that complies with ATX 12 V Specification 2.0 (or later version) and provides a minimum power of 350 W.
- DO NOT forget to connect the 8-pin EATX12V power plug. Otherwise, the system will not boot.
- We recommend that you use a PSU with a higher power output when configuring a system with more power-consuming devices. The system may become unstable or may not boot up if the power is inadequate.
- If you want to use two or more high-end PCI Express x16 cards, use a PSU with 1000W power or above to ensure the system stability.

9. System panel connector (20-5 pin PANEL)

This connector supports several chassis-mounted functions.

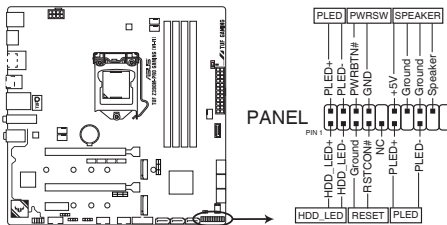

TUF Z390M-PRO GAMING (Wi-Fi) System panel connector

- **System power LED (2-pin or 3-1 pin PLED)**

The 2-pin or 3-1 pin connector is for the system power LED. Connect the chassis power LED cable to this connector. The system power LED lights up when you turn on the system power, and blinks when the system is in sleep mode.

- **Hard disk drive activity LED (2-pin HDD_LED)**

This 2-pin connector is for the HDD Activity LED. Connect the HDD Activity LED cable to this connector. The HDD LED lights up or flashes when data is read from or written to the HDD.

- **System warning speaker (4-pin SPEAKER)**

This 4-pin connector is for the chassis-mounted system warning speaker. The speaker allows you to hear system beeps and warnings.

- **ATX power button/soft-off button (2-pin PWRSW)**

This connector is for the system power button. Pressing the power button turns the system on or puts the system in sleep or soft-off mode depending on the operating system settings. Pressing the power switch for more than four seconds while the system is ON turns the system OFF.

- **Reset button (2-pin RESET)**

This 2-pin connector is for the chassis-mounted reset button for system reboot without turning off the system power.

10. M.2 sockets (M.2_1; M.2_2)

These sockets allow you to install M.2 SSD modules.

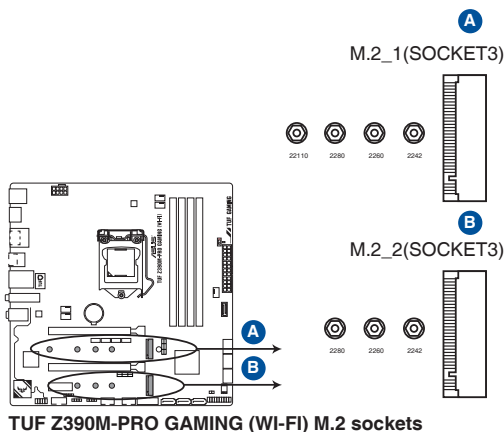

- M.2_1 socket supports PCIe 3.0 x4 and SATA modes M Key design and type 2242 / 2260 / 2280 / 22110 PCIe and SATA storage devices.
- M.2_2 socket supports PCIe 3.0 x4 mode M Key design and type 2242 / 2260 / 2280 PCIe storage devices.
- The M.2_1 socket shares SATA_2 port when using an M.2 SATA mode device. Adjust BIOS settings to use a SATA device.
- These sockets support IRST (Intel® Rapid Storage Technology).



The M.2 SSD module is purchased separately.

11. Digital audio connector (4-1 pin SPDIF_OUT)

This connector is for an additional Sony/Philips Digital Interface (S/PDIF) port. Connect the S/PDIF Out module cable to this connector, then install the module to a slot opening at the back of the system chassis.

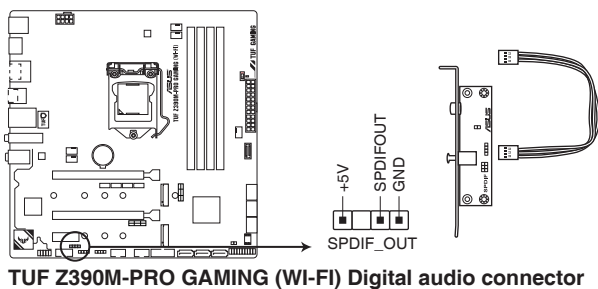

12. RGB headers (4-pin RGB_HEADER1/2)

These headers are for RGB LED strips.

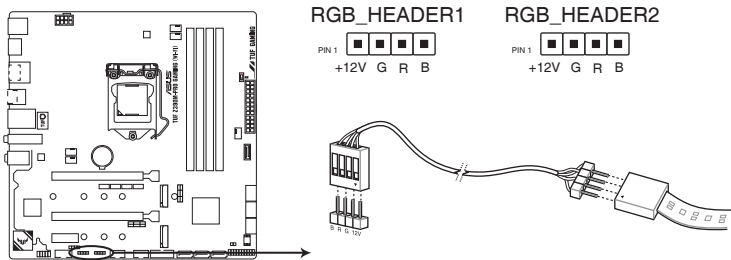

TUF Z390M-PRO GAMING (Wi-Fi) RGB_HEADER connectors



The RGB headers support 5050 RGB multi-color LED strips (12V/G/R/B), with a maximum power rating of 3A (12V), and no longer than 3 m.



Before you install or remove any component, ensure that the ATX power supply is switched off or the power cord is detached from the power supply. Failure to do so may cause severe damage to the motherboard, peripherals, or components.



- Actual lighting and color will vary with LED strip.
- If your LED strip does not light up, check if the RGB LED extension cable and the RGB LED strip is connected in the correct orientation, and the 12V connector is aligned with the 12V header on the motherboard.
- The LED strip will only light up when the system is operating.
- The LED strip is purchased separately.

Basic Installation

2

2.1 Building your PC system



The diagrams in this section are for reference only. The motherboard layout may vary with models, but the installation steps are the same for all models.

2.1.1 CPU installation



Ensure that you install the correct CPU designed for LGA1151 socket only. **DO NOT** install a CPU designed for LGA1155 and LGA1156 sockets on the LGA1151 socket.

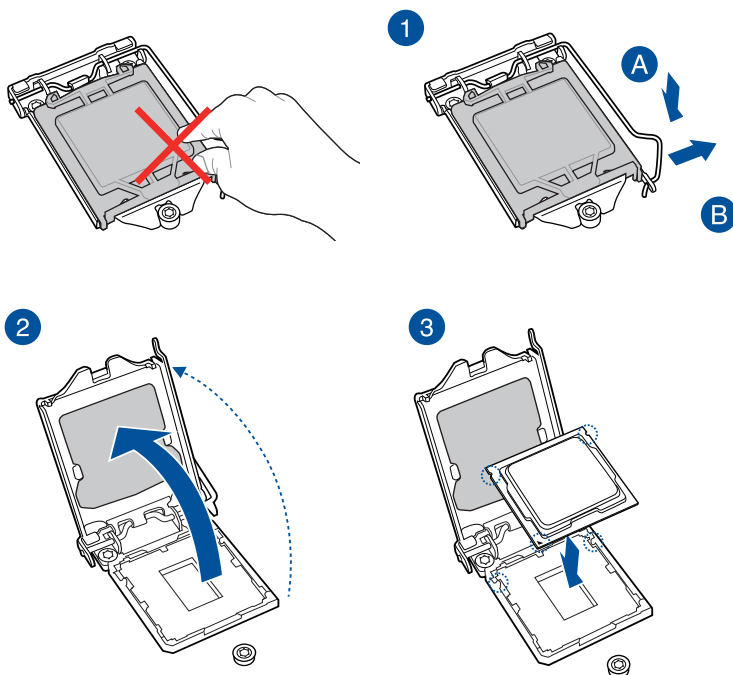

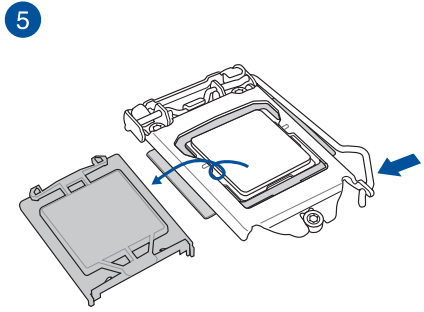
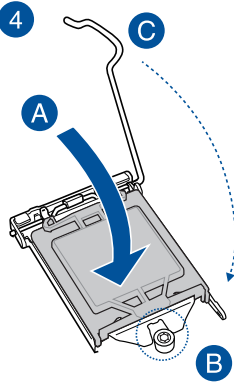

2.1.2 Cooling system installation

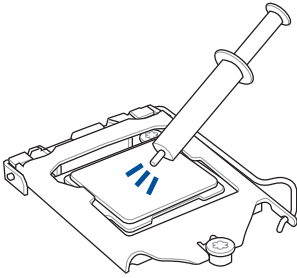

Apply the Thermal Interface Material to the CPU cooling system and CPU before you install the cooling system, if necessary.

To install a CPU heatsink and fan assembly

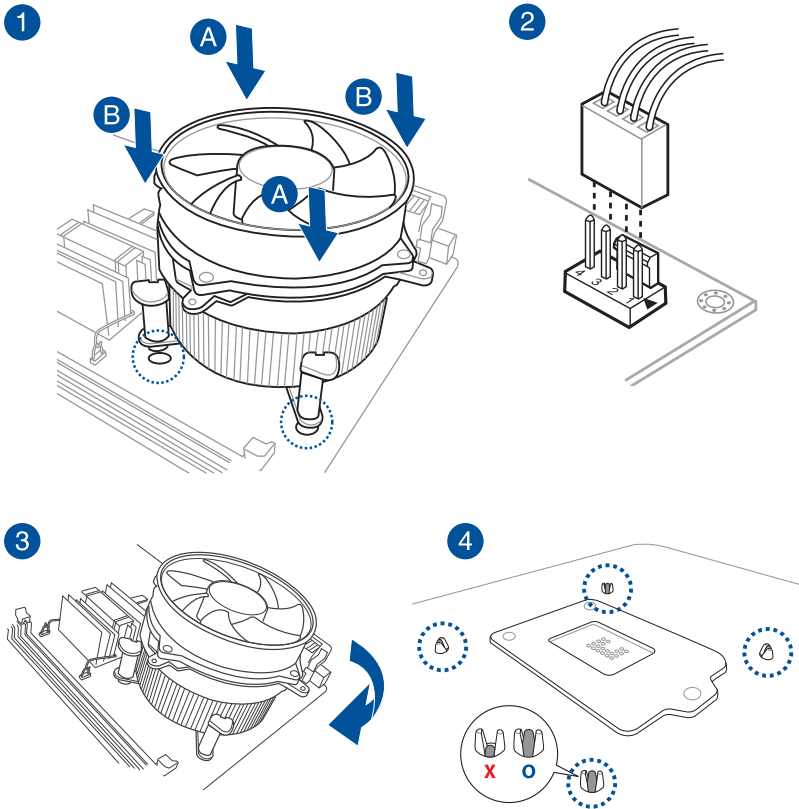

To install an AIO cooler

1

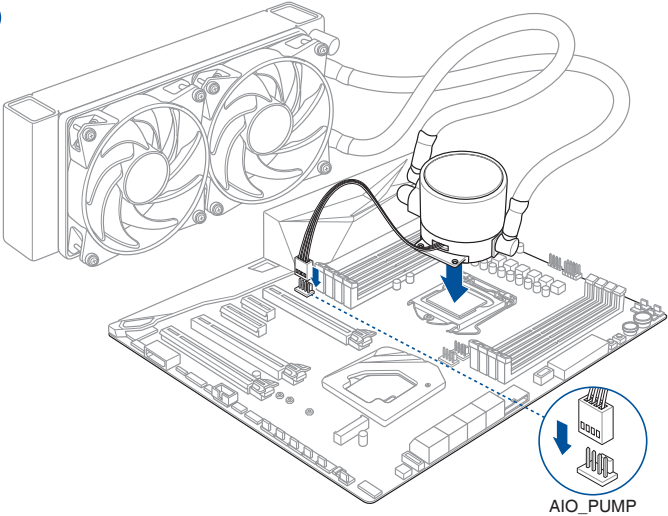

2

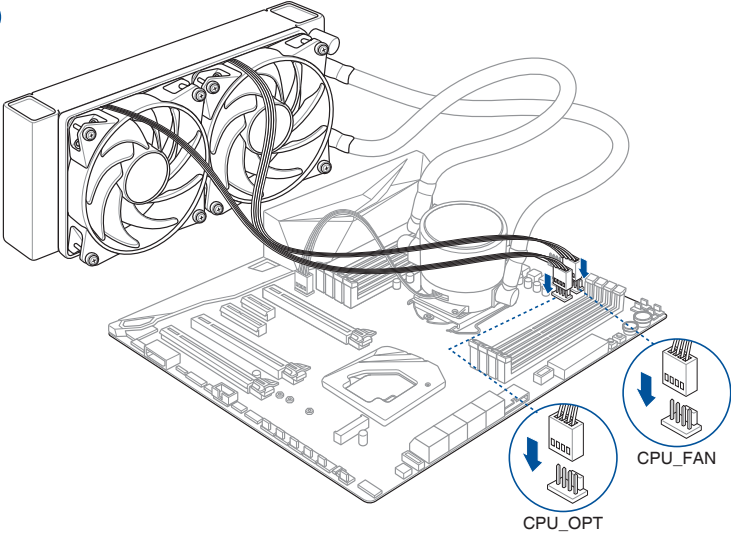

The illustrations in this section are for reference only. Please refer to section 1.1.2 **Motherboard Layout** for the actual location of the header(s).

2.1.3 Motherboard installation

1. Place the motherboard into the chassis, ensuring that its rear I/O ports are aligned to the chassis' rear I/O panel.

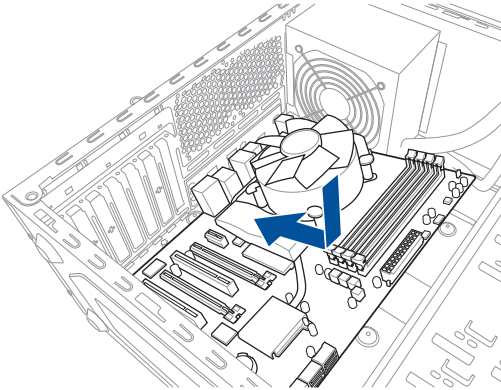

2. Place eight (8) screws into the holes indicated by circles to secure the motherboard to the chassis.

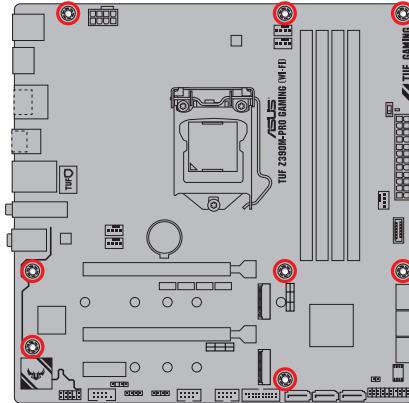
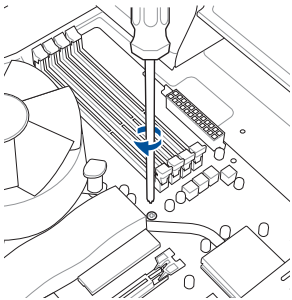

DO NOT overtighten the screws! Doing so can damage the motherboard.

2.1.4 DIMM installation

1

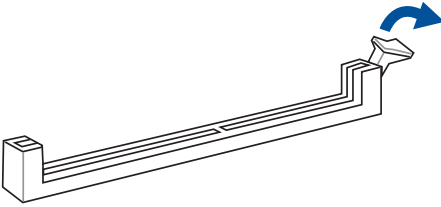

2

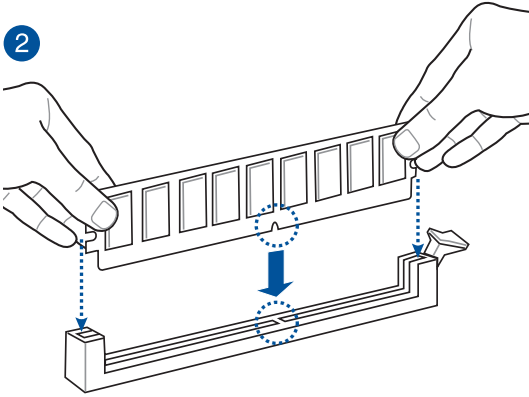

3

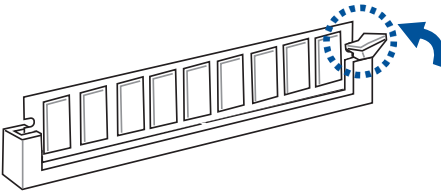

To remove a DIMM

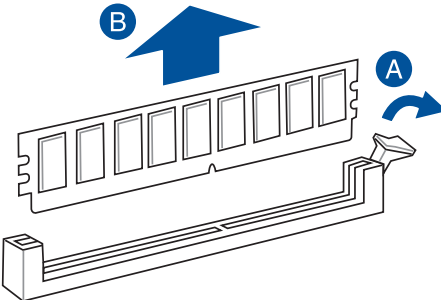

2.1.5 ATX power connection

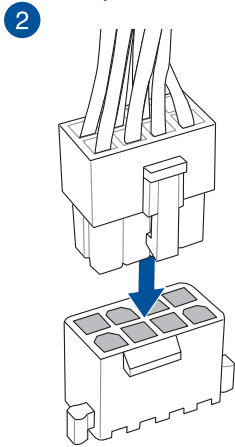
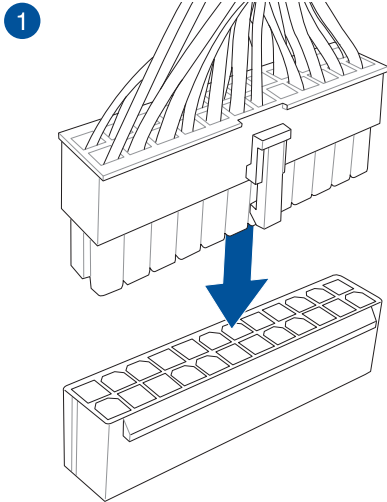

Ensure to connect the 8-pin power plug.

2.1.6 SATA device connection

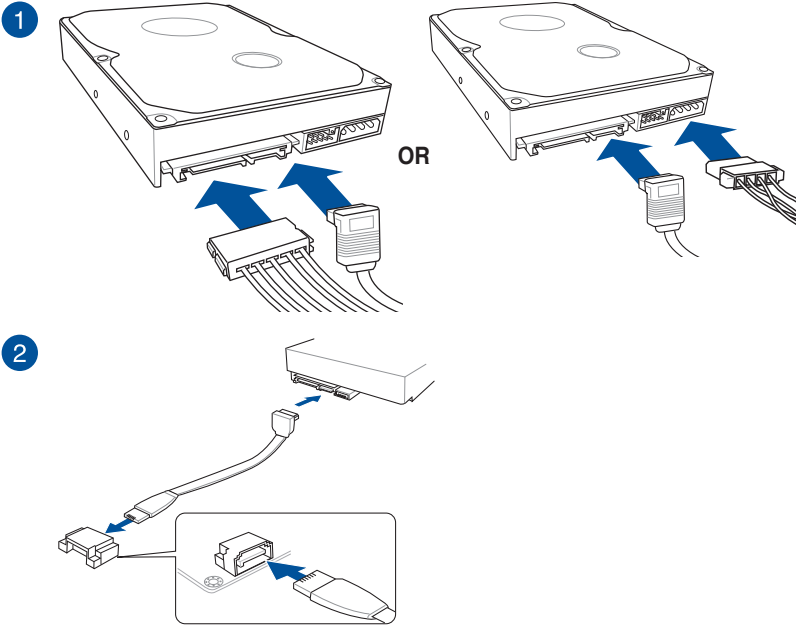

2.1.7 Front I/O connector

To install front panel connector

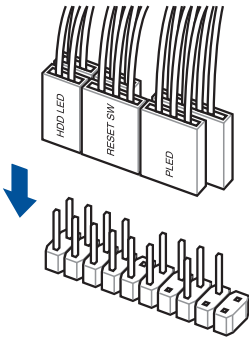

To install USB 3.1 Gen2 connector

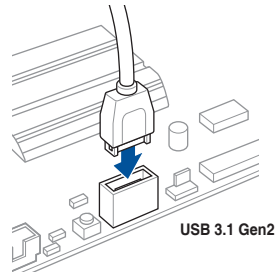

This connector will only fit in one orientation. Push the connector until it clicks into place.

To install USB 3.1 Gen 1 connector

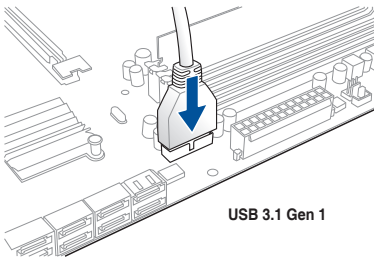

To install USB 2.0 connector

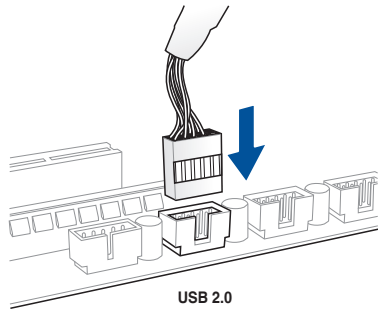

To install front panel audio connector

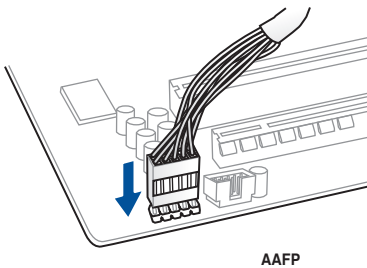

2.1.8 Expansion card installation

To install PCIe x16 cards

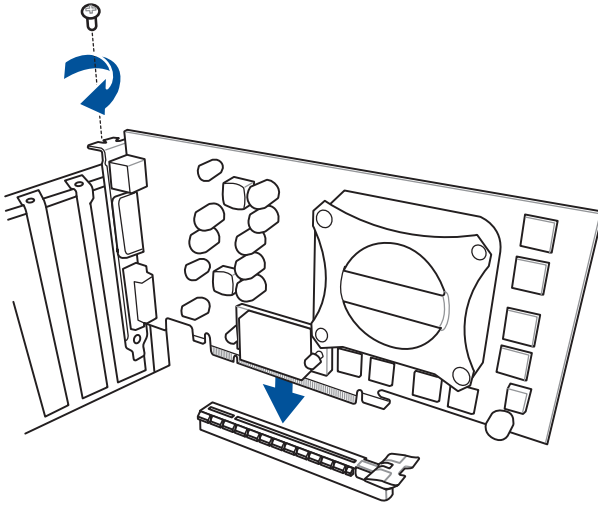

To install PCIe x1 cards

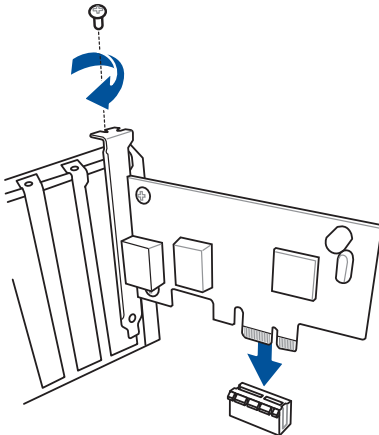

2.1.9 M.2 installation

For type 22110 M.2 on M.2_1 socket

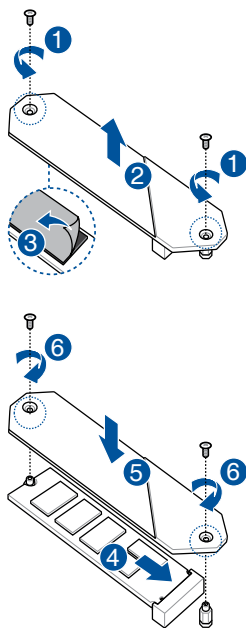

For type 2242 / 2260 / 2280 M.2 on M.2_1 socket

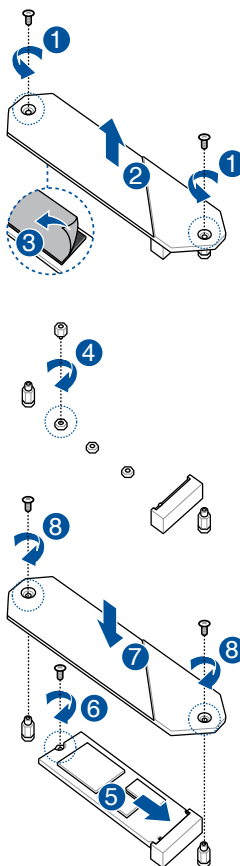

The M.2 is purchased separately.

2.1.10 Wi-Fi antenna installation

Installing the ASUS 2x2 dual band W-Fi antenna

Connect the bundled ASUS 2x2 dual band Wi-Fi antenna connector to the Wi-Fi ports at the back of the chassis.

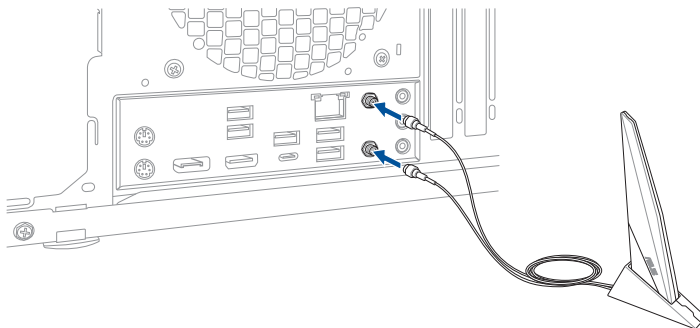

- Ensure that the ASUS 2x2 dual band Wi-Fi antenna is securely installed to the Wi-Fi ports.
- Ensure that the antenna is at least 20 cm away from all persons.



The illustration above is for reference only. The I/O port layout may vary with models, but the Wi-Fi antenna installation procedure is the same for all models.

2.2 Motherboard rear and audio connections

2.2.1 Rear I/O connection

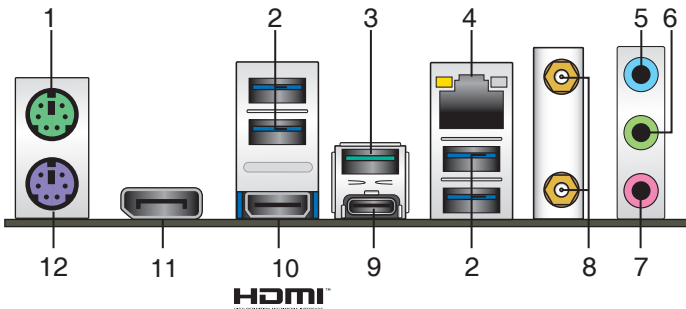

| Rear panel connectors | |
|-----------------------|-----------------------------------------|
| 1. | PS/2 Mouse port |
| 2. | USB 3.1 Gen 1 ports |
| 3. | USB 3.1 Gen 2 port |
| 4. | LAN (RJ-45) port* |
| 5. | Line In port** |
| 6. | Line Out port** |
| 7. | Microphone port** |
| 8. | Wi-Fi 802.11 a/b/g/n/ac, Bluetooth V5.0 |
| 9. | USB 3.1 Gen 1 Type-C port |
| 10. | HDMI port |
| 11. | DisplayPort |
| 12. | PS/2 Keyboard port |

* and **: Refer to the tables on the next page for LAN port LEDs, and audio port definitions.



- USB 3.1 Gen 1/Gen 2 devices can only be used as data storage only.
- Due to the design of the Intel® 300 series chipset, all USB devices connected to the USB 2.0 and USB 3.1 Gen 2 / Gen 1 ports are controlled by the xHCI controller. Some legacy USB devices must update their firmware for better compatibility.
- We strongly recommend that you connect your devices to ports with matching data transfer rate. Please connect your USB 3.1 Gen 1 devices to USB 3.1 Gen 1 ports and your USB 3.1 Gen 2 devices to USB 3.1 Gen 2 ports for faster and better performance for your devices.

* LAN ports LED indications

| Activity Link LED | | Speed LED | |
|-------------------|---------------|-----------|---------------------|
| Status | Description | Status | Description |
| OFF | No link | OFF | 10 Mbps connection |
| ORANGE | Linked | ORANGE | 100 Mbps connection |
| BLINKING | Data activity | GREEN | 1 Gbps connection |

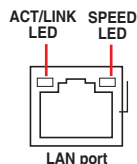

You can disable the LAN controllers in BIOS. Due to hardware design, the LAN port's LEDs may continue to blink even when disabled.

** Audio 2, 4, 6 or 8-channel configuration

| Port | Headset 2-channel | 4-channel | 6-channel | 8-channel |
|-------------------------|-------------------|-------------------|-------------------|-------------------|
| Light Blue (Rear panel) | Line In | Rear Speaker Out | Rear Speaker Out | Rear Speaker Out |
| Lime (Rear panel) | Line Out | Front Speaker Out | Front Speaker Out | Front Speaker Out |
| Pink (Rear panel) | Mic In | Mic In | Bass/Center | Bass/Center |
| Lime (Front panel) | - | - | - | Side Speaker Out |



For a 7.1-channel speaker setup, refer to the 7.1-channel configuration in the table.

2.2.2 Audio I/O connections

Audio I/O ports

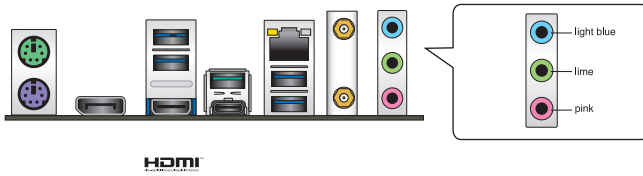

Connect to Headphone and Mic



Connect to Stereo Speakers

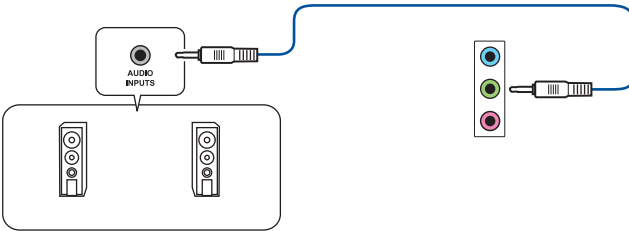

Connect to 2 Speakers

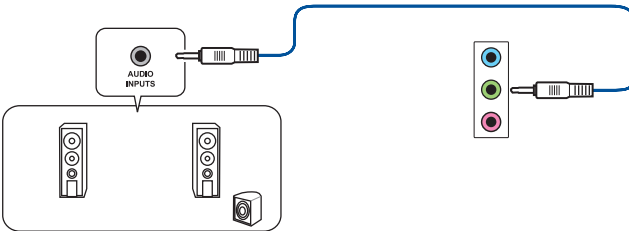

Connect to 4 Speakers

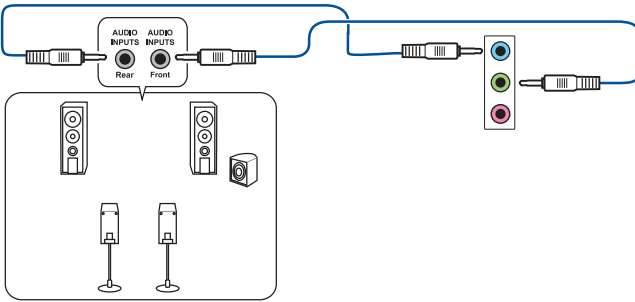

Connect to 6 Speakers

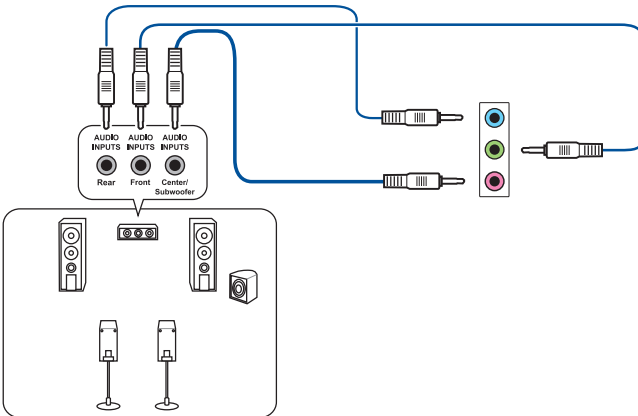

Connect to 8 Speakers

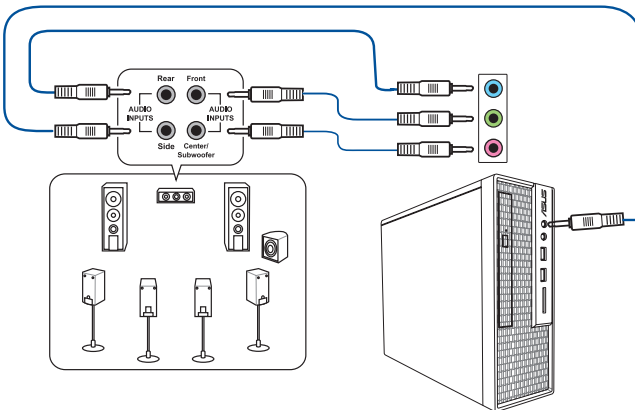

2.3 Starting up for the first time

1. After making all the connections, replace the system case cover.
2. Ensure that all switches are off.
3. Connect the power cord to the power connector at the back of the system chassis.
4. Connect the power cord to a power outlet that is equipped with a surge protector.
5. Turn on the devices in the following order:
 - a. Monitor
 - b. External storage devices (starting with the last device on the chain)
 - c. System power
6. After applying power, the system power LED on the system front panel case lights up. For systems with ATX power supplies, the system LED lights up when you press the ATX power button. If your monitor complies with the “green” standards or if it has a “power standby” feature, the monitor LED may light up or change from orange to green after the system LED turns on.

The system then runs the power-on self tests (POST). While the tests are running, the BIOS beeps (refer to the BIOS beep codes table) or additional messages appear on the screen. If you do not see anything within 30 seconds from the time you turned on the power, the system may have failed a power-on test. Check the jumper settings and connections or call your retailer for assistance.

| BIOS Beep | Description |
|-------------------------------------------------------------------------|--------------------------------------------------------------------|
| One short beep | VGA detected Quick boot set to disabled No keyboard detected |
| One continuous beep followed by two short beeps then a pause (repeated) | No memory detected |
| One continuous beep followed by three short beeps | No VGA detected |
| One continuous beep followed by four short beeps | Hardware component failure |

7. At power on, hold down the <Delete> key to enter the BIOS Setup. Follow the instructions in Chapter 3.

2.4 Turning off the computer

While the system is ON, press the power button for less than four seconds to put the system on sleep mode or soft-off mode, depending on the BIOS setting. Press the power button for more than four seconds to let the system enter the soft-off mode regardless of the BIOS setting.

BIOS Setup

3

3.1 Knowing BIOS



The new ASUS UEFI BIOS is a Unified Extensible Interface that complies with UEFI architecture, offering a user-friendly interface that goes beyond the traditional keyboard-only BIOS controls to enable a more flexible and convenient mouse input. You can easily navigate the new UEFI BIOS with the same smoothness as your operating system. The term “BIOS” in this user manual refers to “UEFI BIOS” unless otherwise specified.

BIOS (Basic Input and Output System) stores system hardware settings such as storage device configuration, overclocking settings, advanced power management, and boot device configuration that are needed for system startup in the motherboard CMOS. In normal circumstances, the default BIOS settings apply to most conditions to ensure optimal performance. **DO NOT change the default BIOS settings** except in the following circumstances:

- An error message appears on the screen during the system bootup and requests you to run the BIOS Setup.
- You have installed a new system component that requires further BIOS settings or update.



Inappropriate BIOS settings may result to instability or boot failure. **We strongly recommend that you change the BIOS settings only with the help of a trained service personnel.**



When downloading or updating the BIOS file, rename it as **TZ390MPW.CAP** for this motherboard.

3.2 BIOS setup program

Use the BIOS Setup to update the BIOS or configure its parameters. The BIOS screen include navigation keys and brief onscreen help to guide you in using the BIOS Setup program.

Entering BIOS at startup

To enter BIOS Setup at startup, press <Delete> or <F2> during the Power-On Self Test (POST). If you do not press <Delete> or <F2>, POST continues with its routines.

Entering BIOS Setup after POST

To enter BIOS Setup after POST:

- Press <Ctrl>+<Alt>+<Delete> simultaneously.
- Press the reset button on the system chassis.
- Press the power button to turn the system off then back on. Do this option only if you failed to enter BIOS Setup using the first two options.

After doing either of the three options, press <Delete> key to enter BIOS.



-
- The BIOS setup screens shown in this section are for reference purposes only, and may not exactly match what you see on your screen.
 - Ensure that a USB mouse is connected to your motherboard if you want to use the mouse to control the BIOS setup program.
 - If the system becomes unstable after changing any BIOS setting, load the default settings to ensure system compatibility and stability. Select the **Load Optimized Defaults** item under the **Exit** menu or press hotkey <F5>. See section 3.10 **Exit Menu** for details.
 - If the system fails to boot after changing any BIOS setting, try to clear the CMOS and reset the motherboard to the default value. See section 1.1.7 **Jumpers** for information on how to erase the RTC RAM via the Clear CMOS jumper.
 - The BIOS setup program does not support the Bluetooth devices.
-



Please visit ASUS website for the detailed BIOS content manual.

BIOS menu screen

The BIOS Setup program can be used under two modes: **EZ Mode** and **Advanced Mode**. You can change modes from **Setup Mode** in **Boot menu** or by pressing the <F7> hotkey.

3.2.1 EZ Mode

The EZ Mode provides you an overview of the basic system information, and allows you to select the display language, system performance, mode and boot device priority. To access the Advanced Mode, select **Advanced Mode** or press the <F7> hotkey for the advanced BIOS settings.



The default screen for entering the BIOS setup program can be changed. Refer to the **Setup Mode** item in section **Boot menu** for details.

The screenshot shows the 'UEFI BIOS Utility - EZ Mode' interface. Key components and their functions are annotated as follows:

- Information Panel:** Displays system properties of the selected mode. Includes CPU Temperature (41°C), CPU Core Voltage (0.577 V), Motherboard Temperature (28°C), DRAM Status, Storage Information (KingstonDataTraveler 3.0PMAP), X.M.P. (Disabled), and FAN Profile (CPU FAN at 2238 RPM).
- EZ System Tuning:** Allows selecting a pre-configured profile for improved system performance or energy savings.
- Boot Priority:** Allows choosing one or more boot devices to be prioritized.
- Navigation:** Includes buttons for Default(F5), Save & Exit(F10), Advanced Mode(F7), and Search on FAQ.
- Search (F9):** A search function for finding specific settings.
- AURA ON/OFF (F4):** A toggle for the AURA lighting effect.
- Intel Rapid Storage Technology:** A section for managing storage RAID and system overlocking.
- CPU Fan Control:** A graph showing CPU Fan speed (0-100%) vs. temperature (0-100°C) with a QFan Control button.

Annotations with red lines pointing to specific UI elements include:

- Displays a quick overview of the system status** (points to the Information panel)
- Creates storage RAID and configures system overlocking** (points to the Intel Rapid Storage Technology section)
- Selects the display language of the BIOS setup program** (points to the Language dropdown)
- Displays the system properties of the selected mode. Click < > to switch EZ System Tuning modes** (points to the EZ System Tuning section)
- Search (F9)** (points to the Search icon)
- AURA ON/OFF (F4)** (points to the AURA icon)
- Enables or disables the SATA RAID mode for Intel Rapid Storage Technology** (points to the RAID mode dropdown)
- Displays the CPU Fan's speed. Click the button to manually tune the fans** (points to the QFan Control button)
- Loads optimized default settings** (points to the Default(F5) button)
- Saves the changes and resets the system** (points to the Save & Exit(F10) button)
- Click to go to Advanced mode** (points to the Advanced Mode(F7) button)
- Search on the FAQ** (points to the Search on FAQ button)
- Click to display boot devices** (points to the Boot Priority section)
- Selects the boot device priority** (points to the boot device selection area)



The boot device options vary depending on the devices you installed to the system.

3.2.2 Advanced Mode

The Advanced Mode provides advanced options for experienced end-users to configure the BIOS settings. The figure below shows an example of the Advanced Mode. Refer to the following sections for the detailed configurations.



To switch from Advanced Mode to EZ Mode, click **EZ Mode(F7)** or press the <F7> hotkey.

The screenshot shows the BIOS Advanced Mode interface with the following labels and annotations:

- Configuration fields**: Points to the top status bar containing date, time, language, and function keys.
- Pop-up Menu**: Points to the 'My Favorites' menu.
- Menu bar**: Points to the navigation tabs: My Favorites, Main, Ai Tweaker, Advanced, Monitor, Boot, Tool, Exit.
- Language**: Points to the 'English' language selection.
- MyFavorite(F3)**: Points to the 'MyFavorite(F3)' function key.
- Qfan Control(F6)**: Points to the 'Qfan Control(F6)' function key.
- EZ Tuning Wizard(F11)**: Points to the 'EZ Tuning Wizard(F11)' function key.
- Search(F9)**: Points to the 'Search(F9)' function key.
- Scroll bar**: Points to the 'AURA ON/OFF(F4)' function key.
- Hardware Monitor**: Points to the right-hand panel displaying CPU, Memory, and Voltage information.
- Menu items**: Points to the 'My Favorites' menu.
- General help**: Points to the information icon (i) in the bottom left.
- Last modified settings**: Points to the 'Last Modified' text at the bottom.
- Go back to EZ Mode**: Points to the 'EzMode(F7) [F7]' button at the bottom.
- Hot Keys**: Points to the 'Hot Keys [F7]' text at the bottom.
- Search on the FAQ**: Points to the 'Search on FAQ' text at the bottom.
- Displays hardware monitoring data**: Points to the Hardware Monitor panel on the right.

Menu bar

The menu bar on top of the screen has the following main items:

| | |
|------------------------|-------------------------------------------------------------------------------------|
| My Favorites | For saving the frequently-used system settings and configuration. |
| Main | For changing the basic system configuration |
| Extreme Tweaker | For changing the overclocking settings |
| Advanced | For changing the advanced system settings |
| Monitor | For displaying the system temperature, power status, and changing the fan settings. |
| Boot | For changing the system boot configuration |
| Tool | For configuring options for special functions |
| Exit | For selecting the exit options and loading default settings |

Menu items

The highlighted item on the menu bar displays the specific items for that menu. For example, selecting **Main** shows the Main menu items.

The other items (My Favorites, Ai Tweaker, Advanced, Monitor, Boot, Tool, and Exit) on the menu bar have their respective menu items.

Submenu items

A greater than sign (>) before each item on any menu screen means that the item has a submenu. To display the submenu, select the item and press <Enter>.

Language

This button above the menu bar contains the languages that you can select for your BIOS. Click this button to select the language that you want to display in your BIOS screen.

My Favorites(F3)

This button above the menu bar shows all BIOS items in a Tree Map setup. Select frequently-used BIOS settings and save it to MyFavorites menu.



Refer to section **3.3 My Favorites** for more information.

Q-Fan Control(F6)

This button above the menu bar displays the current settings of your fans. Use this button to manually tweak the fans to your desired settings.



Refer to section **3.2.3 QFan Control** for more information.

EZ Tuning Wizard(F11)

This button above the menu bar allows you to view and tweak the overclocking settings of your system. It also allows you to change the motherboard's SATA mode from AHCI to RAID mode.



Refer to section **3.2.4 EZ Tuning Wizard** for more information.

Search (F9)

This button allows you to search for BIOS items by entering its name, enter the item name to find the related item listing.

AURA (F4)

This button allows you to turn the RGB LED lighting or functional LED on or off.

[All On]: All LEDs (Aura or Functional) will be enabled.

[Aura Only]: Aura LEDs will be enabled and functional LEDs will be disabled.

[Aura Off]: Aura LEDs will be disabled, however functional LEDs will still be enabled.

[Stealth Mode]: All LEDs (Aura and Functional) will be disabled.

Search on FAQ

Move your mouse over this button to show a QR code, scan this QR code on your mobile device to connect to the BIOS FAQ web page of the ASUS support website. You can also scan the following QR code:



Scroll bar

A scroll bar appears on the right side of a menu screen when there are items that do not fit on the screen. Press the Up/Down arrow keys or <Page Up> / <Page Down> keys to display the other items on the screen.

General help

At the bottom of the menu screen is a brief description of the selected item. Use <F12> key to capture the BIOS screen and save it to the removable storage device.

Configuration fields

These fields show the values for the menu items. If an item is user-configurable, you can change the value of the field opposite the item. You cannot select an item that is not user-configurable.

A configurable field is highlighted when selected. To change the value of a field, select it and press <Enter> to display a list of options.

Hot keys

This button contains the navigation keys for the BIOS setup program. Use the navigation keys to select items in the menu and change the settings.

Last Modified button

This button shows the items that you last modified and saved in BIOS Setup.

3.2.3 QFan Control

The QFan Control allows you to set a fan profile or manually configure the operating speed of your CPU and chassis fans.

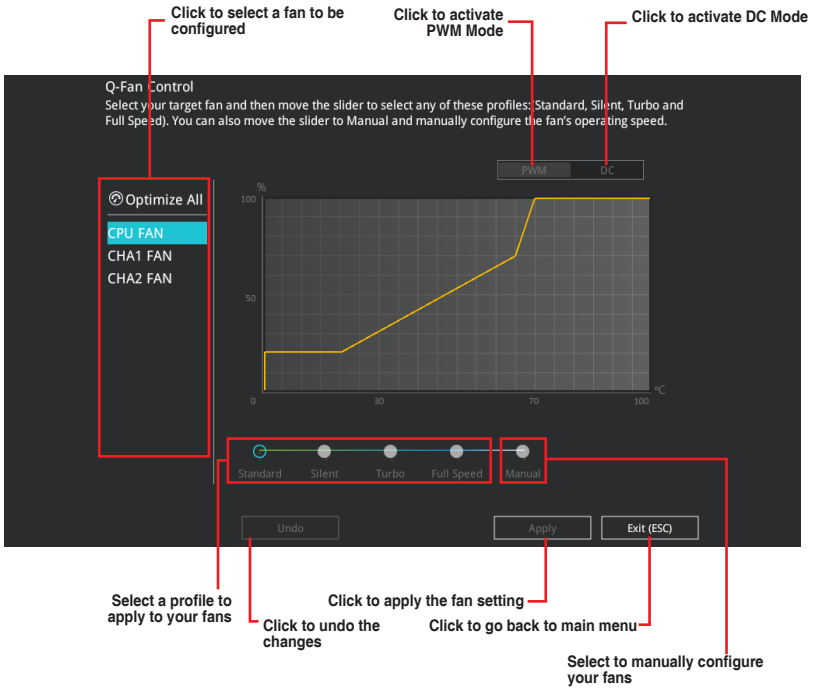

Configuring fans manually

Select **Manual** from the list of profiles to manually configure your fans' operating speed.

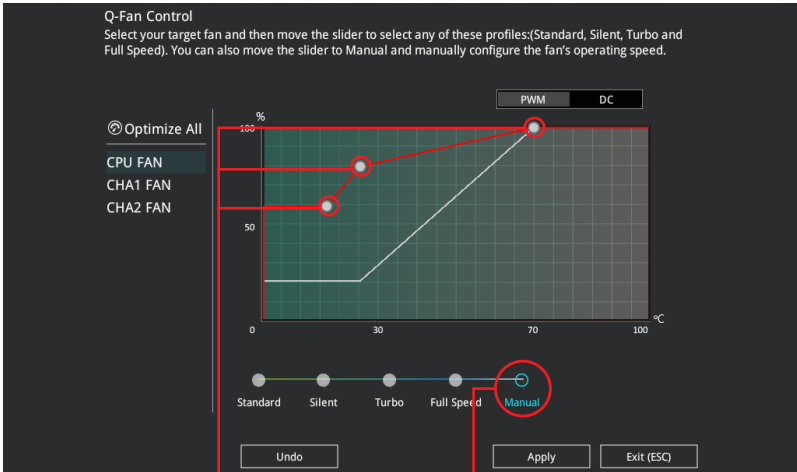

Speed points

Select to manually
configure your fans

To configure your fans:

1. Select the fan that you want to configure and to view its current status.
2. Click and drag the speed points to adjust the fans' operating speed.
3. Click **Apply** to save the changes then click **Exit (ESC)**.

3.2.4 EZ Tuning Wizard

EZ Tuning Wizard allows you to easily overclock your CPU and DRAM, computer usage, and CPU fan to their best settings. You can also set RAID in your system using this feature.

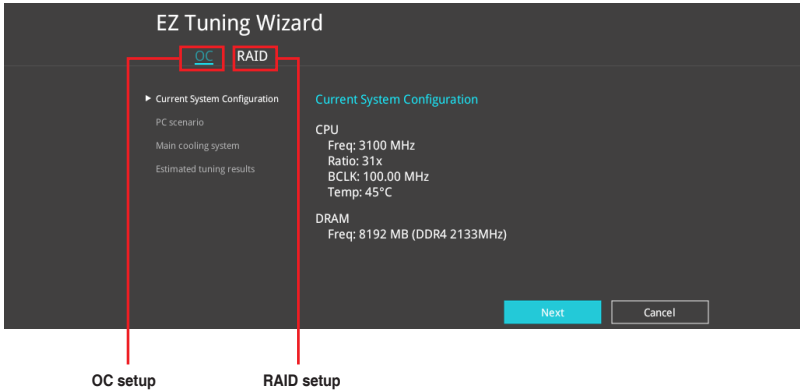

OC Tuning

To start OC Tuning:

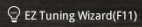
1. Press <F11> on your keyboard or click  from the BIOS screen to open EZ Tuning Wizard screen.
2. Click **OC** then click **Next**.
3. Select a PC scenario **Daily Computing** or **Gaming/Media Editing**, then click **Next**.

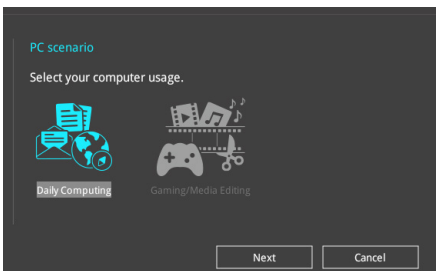

4. Select a Main Cooling System **BOX cooler**, **Tower cooler**, **Water cooler**, or **I'm not sure**, then click **Next**.

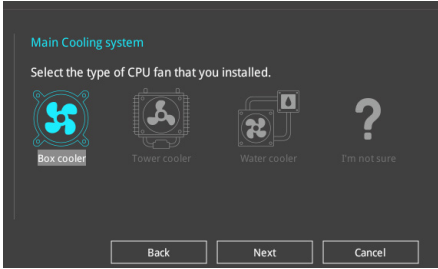

5. After selecting the Main Cooling System, click **Next** then click **Yes** to start the OC Tuning.

Creating RAID

To create RAID:

1. Press <F11> on your keyboard or click **EZ Tuning Wizard(F11)** from the BIOS screen to open EZ Tuning Wizard screen.
2. Click **RAID** then click **Next**.



- Ensure that your HDDs have no existing RAID volumes.
- Ensure to connect your HDDs to Intel® SATA connectors.

3. Select the port that you want to set to [RAID] mode, **PCIe** or **SATA**, then click **Next**.

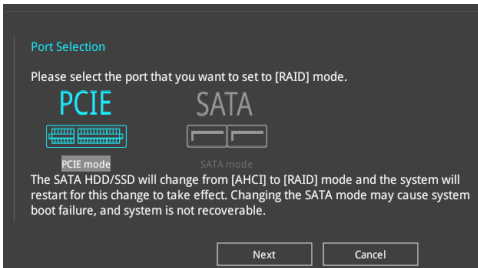

4. Select the type of storage for your RAID, **Easy Backup** or **Super Speed**, then click **Next**.

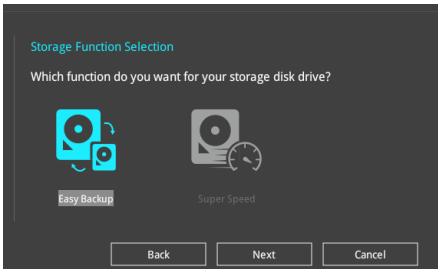

- a. For Easy Backup, click **Next** then select from **Easy Backup (RAID1)** or **Easy Backup (RAID10)**.

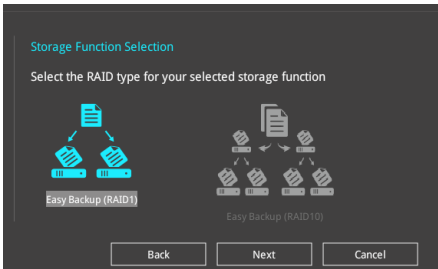

You can only select Easy Backup (RAID 10) if you connect four (4) HDDs.

- b. For Super Speed, click **Next** then select from **Super Speed (RAID0)** or **Super Speed (RAID5)**.

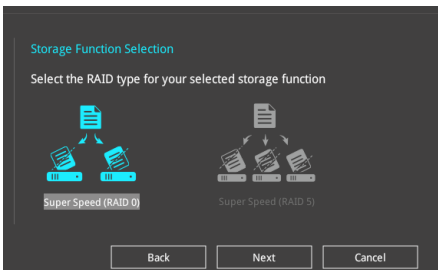

5. After selecting the type of RAID, click **Next** then click **Yes** to continue the RAID setup.
6. After the RAID setup is done, click **Yes** to exit the setup then click **OK** to reset your system.

3.3 My Favorites

My Favorites is your personal space where you can easily save and access your favorite BIOS items.

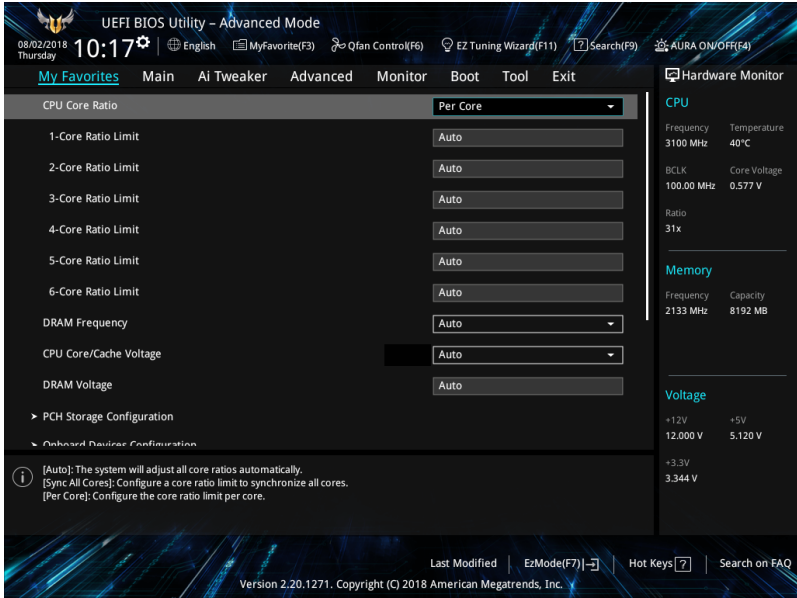

My Favorites comes with several performance, power saving, and fast boot related items by default. You can personalize this screen by adding or removing items.

Adding items to My Favorites

To add BIOS items:

1. Press <F3> on your keyboard or click **MyFavorites(F3)** from the BIOS screen to open Setup Tree Map screen.
2. On the Setup Tree Map screen, select the BIOS items that you want to save in My Favorites screen.

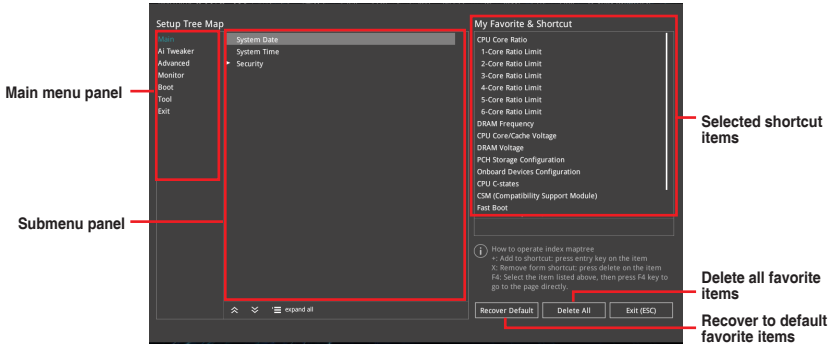

3. Select an item from main menu panel, then click the submenu that you want to save as favorite from the submenu panel and click **+** or press <Enter> on your keyboard.



You cannot add the following items to My Favorite items:

- Items with submenu options
- User-managed items such as language and boot order
- Configuration items such as Memory SPD Information, system time and date.

4. Click **Exit (ESC)** or press <Esc> key to close Setup Tree Map screen.
5. Go to My Favorites menu to view the saved BIOS items.

3.4 Main menu

The Main menu screen appears when you enter the Advanced Mode of the BIOS Setup program. The Main menu provides you an overview of the basic system information, and allows you to set the system date, time, language, and security settings.

Security

The Security menu items allow you to change the system security settings.



- If you have forgotten your BIOS password, erase the CMOS Real Time Clock (RTC) RAM to clear the BIOS password. See section 1.1.7 **Jumpers** for information on how to erase the RTC RAM via the Clear CMOS jumper.
- The Administrator or User Password items on top of the screen show the default **[Not Installed]**. After you set a password, these items show **[Installed]**.

3.5 Ai Tweaker menu

The Ai Tweaker menu items allow you to configure overclocking-related items.



Be cautious when changing the settings of the Ai Tweaker menu items. Incorrect field values can cause the system to malfunction



The configuration options for this section vary depending on the CPU and DIMM model you installed on the motherboard.

Ai Overclock Tuner

Allows you to select the CPU overclocking options to achieve the desired CPU internal frequency. Configuration options:

- | | |
|----------|-------------------------------------------------------------------------------------------------------------------------------------------------------------------------------------------------------|
| [Auto] | Loads the optimal settings for the system. |
| [Manual] | Allows you to individually set overclocking parameters. |
| [X.M.P.] | If you install memory modules supporting the eXtreme Memory Profile (X.M.P.) Technology, choose this item to set the profiles supported by your memory modules for optimizing the system performance. |



The [X.M.P.] configuration option appears only when you install memory modules supporting the eXtreme Memory Profile(X.M.P.) Technology.



The following item appears only when you set the Ai Overclocking Tuner to **[Manual]**.

BCLK Frequency

This item allows you to set the BCLK (base clock) frequency to enhance the system performance. Use the <+> or <-> to adjust the value.



We recommend you to set the value based on the CPU specification, as high BCLK frequencies may damage the CPU permanently.

ASUS MultiCore Enhancement

- [Auto] Allows you to maximize the overclocking performance optimized by ASUS core ratio settings.
- [Disabled] Allows you to set to default core ratio settings.
- [Enabled] Allows you to set the core ratio settings.

CPU Core Ratio

This item allows you to set the CPU core ratios.
Configuration options: [Auto] [Sync All Cores] [Per Core]

DRAM Frequency

This item allows you to set the memory operating frequency. The configurable options vary with the BCLK (base clock) frequency setting. Select the auto mode to apply the optimized setting.
Configuration options: [Auto] [DDR4-800MHz] - [DDR4-8533MHz]

OC Tuner

This item allows you to automatically overclock the CPU and DRAM frequencies and voltage for an enhanced system performance.

- [Keep Current Settings] Keep the current settings without changing anything.
- [OC Tuner I] Applies air cooling overclocking conditions.
- [OC Tuner II] Applies water cooling overclocking conditions.



Ensure to use water cooling device before selecting [OC Tuner II].

Internal CPU Power Management

The subitems in this menu allow you to set the CPU ratio and features.

Intel(R) SpeedStep(tm)

Allows the operating system to dynamically adjust the processor voltage and cores frequency to decrease the average power consumption and decrease average heat production.

Configuration options: [Auto] [Enabled] [Disabled]

Turbo Mode

Allows you to enable your processor cores to run faster than the base operating frequency when it is below power, current and specification limit. Configuration options: [Disabled] [Enabled]

3.6 Advanced menu

The Advanced menu items allow you to change the settings for the CPU and other system devices.



Be cautious when changing the settings of the Advanced menu items. Incorrect field values can cause the system to malfunction.

3.6.1 Platform Misc Configuration

The items in this menu allow you to change the ASPM for PCH and SA PCI Express.

3.6.2 CPU Configuration

The items in this menu show the CPU-related information that the BIOS automatically detects.



The items in this menu may vary based on the CPU installed.

CPU - Power Management Control

This item allows you to manage and configure the CPU's power.

Intel(R) SpeedStep(tm)

This item allows more than two frequency to be supported.

Configuration options: [Auto] [Disabled] [Enabled]

Intel(R) Speed Shift Technology

This item allows you to enable or disable the Intel(R) Speed Shift Technology support. When enabled, CPPC v2 interface allows hardware controlled P-states.

Configuration options: [Auto] [Disabled] [Enabled]

Turbo Mode

This item allows you to automatically set the CPU cores to run faster than the base operating frequency when it is below the operating power, current and temperature specification limit.

Configuration options: [Enabled] [Disabled]

CPU C states

This item allows you to set the power saving of the CPU states.

Configuration options: [Auto] [Disabled] [Enabled]

CFG Lock

This item allows you to configure MSR 0xE2[15]. CFG lock bit. Configuration options: [Disabled] [Enabled]

3.6.3 System Agent (SA) Configuration

The items in this menu allow you to adjust the Link Speed for PEG Port and Multi-Monitor.

3.6.4 PCH Configuration

The items in this menu allow you to adjust the PCH PCI Express speed.

PCI Express Configuration

This item allows you to configure the PCI Express slots.

PCIe Speed

This item allows your system to automatically select the PCI Express port speed.

Configuration options: [Auto] [Gen1] [Gen2] [Gen3]

3.6.5 PCH Storage Configuration

While entering Setup, the BIOS automatically detects the presence of SATA devices. The SATA Port items show **Not Present** if no SATA device is installed to the corresponding SATA port.

SATA Controller(s)

This item allows you to enable or disable the SATA Device.

Configuration options: [Enabled] [Disabled]



The following items appear only when **SATA Controller(s)** is set to **[Enabled]**.

SATA Mode Selection

This item allows you to set the SATA configuration.

[AHCI]

Set to [AHCI] when you want the SATA hard disk drives to use the AHCI (Advanced Host Controller Interface). The AHCI allows the onboard storage driver to enable advanced Serial ATA features that increases storage performance on random workloads by allowing the drive to internally optimize the order of commands.

[Intel RST Premium With Intel Optane System Acceleration(RAID)]

Set to [Intel RST Premium With Intel Optane System Acceleration(RAID)] when you want to create a RAID configuration from the SATA hard disk drives.

SMART Self Test

SMART (Self-Monitoring, Analysis and Reporting Technology) is a monitoring system that shows a warning message during POST (Power-on Self Test) when an error occurs in the hard disks.

Configuration options: [On] [Off]

SATA6G_1 - SATA6G_6

SATA6G_1 - SATA6G_6

This item allows you to enable or disable the selected SATA port.

Configuration options: [Disabled] [Enabled]

Hot Plug

These items appears only when the SATA Mode Selection is set to **[AHCI]** and allows you to enable or disable SATA Hot Plug Support.

Configuration options: [Disabled] [Enabled]

3.6.6 PCH-FW Configuration

This item allows you to configure the firmware TPM.

3.6.7 Onboard Devices Configuration

The items in this menu allow you to switch between PCIe Lanes and configure onboard devices.

Hyper M.2X16 [Enabled][Disabled]

[Disabled] Only one SSD installed onto the Hyper M.2 X16 card can be detected.

[Enabled] Two or three SSDs installed onto the Hyper M.2 X16 card can be detected.



The number of SSDs that can be detected varies with the configurations of the PCIe X16 slots.

HD Audio

This item allows you to use the Azalia High Definition Audio Controller.
Configuration options: [Disabled] [Enabled]

Intel LAN Controller

This item allows you to enable or disable the Intel LAN controllers.
Configuration options: [Disabled] [Enabled]

LED lighting

When system is in working state

This item allows you to turn the RGB LED lighting on or off when the system is in the working state.

Configuration options: [On] [Off]

When system is in sleep, hibernate or soft off states

This item allows you to turn the RGB LED lighting on or off when the system is in the sleep, hibernate or soft off states.

Configuration options: [On] [Off]

3.6.8 APM Configuration

The items in this menu allow you to set system wake and sleep settings.

ErP Ready

This item allows you to switch off some power at S4+S5 or S5 to get the system ready for ErP requirement. When set to **[Enabled]**, all other PME options are switched off.

Configuration options: [Disabled] [Enable(S4+S5)] [Enable(S5)]

3.6.9 PCI Subsystem Settings

SR-IOV Support

This option enables or disables Single Root IO Virtualization Support if the system has SRIOV capable PCIe devices.

Configuration options: [Disabled] [Enabled]

3.6.10 USB Configuration

The items in this menu allow you to change the USB-related features.



The **Mass Storage Devices** item shows the auto-detected values. If no USB device is detected, the item shows **None**.

USB Single Port Control

This item allows you to enable or disable the individual USB ports.



Refer to section **1.1.2 Motherboard layout** for the location of the USB ports.

3.6.11 Network Stack Configuration

The items in this menu allow you to configure Ipv4 / Ipv6 PXE support.

3.6.12 NVMe Configuration

This menu displays the NVMe controller and Drive information of the connected devices.

3.6.13 HDD/SSD SMART Information

The items in this menu display the SMART information of the connected devices.



NVM Express devices do not support SMART information.

3.7 Monitor menu

The Monitor menu displays the system temperature/power status, and allows you to change the fan settings.

Qfan Configuration

Qfan Tuning

Click this item to automatically detect the lowest speed and configure the minimum duty cycle for each fan.

3.8 Boot menu

The Boot menu items allow you to change the system boot options.

Boot Configuration

Fast Boot

[Disabled] Allows your system to go back to its normal boot speed.

[Enabled] Allows your system to accelerate the boot speed.



The following item appears only when you set **Fast Boot** to **[Enabled]**.

Next Boot after AC Power Loss

[Normal Boot] Returns to normal boot on the next boot after an AC power loss.

[Fast Boot] Accelerates the boot speed on the next boot after an AC power loss.

Setup Mode

[Advanced Mode] This item allows you to go to Advanced Mode of the BIOS after POST.

[EZ Mode] This item allows you to go to EZ Mode of the BIOS after POST.

CSM (Compatibility Support Module)

This item allows you to configure the CSM (Compatibility Support Module) items to fully support the various VGA, bootable devices and add-on devices for better compatibility.

Launch CSM

[Enabled] For better compatibility, enable the CSM to fully support the non-UEFI driver add-on devices or the Windows® UEFI mode.

[Disabled] Disable the CSM to fully support the non-UEFI driver add-on devices or the Windows® UEFI mode.



The following items appear only when you set **Launch CSM** to **[Enabled]**.

Boot Devices Control

This item allows you to select the type of devices that you want to boot.

Configuration options: [UEFI and Legacy OPROM] [Legacy OPROM only] [UEFI only]

Boot from Network Devices

This item allows you to select the type of network devices that you want to launch.

Configuration options: [Ignore] [Legacy only] [UEFI only]

Boot from Storage Devices

This item allows you to select the type of storage devices that you want to launch.

Configuration options: [Ignore] [Legacy only] [UEFI only]

Boot from PCI-E/PCI Expansion Devices

This item allows you to select the type of PCI-E/PCI expansion devices that you want to launch.

Configuration options: [Ignore] [Legacy only] [UEFI only]

Secure Boot

This item allows you to configure the Windows® Secure Boot settings and manage its keys to protect the system from unauthorized access and malwares during POST.

Boot Option Priorities

These items specify the boot device priority sequence from the available devices. The number of device items that appears on the screen depends on the number of devices installed in the system.



-
- To access Windows® OS in Safe Mode, press <F8> after POST.
 - To select the boot device during system startup, press <F8> when the ASUS Logo appears.
-

Boot Override

These items displays the available devices. The number of device items that appears on the screen depends on the number of devices installed in the system. Click an item to start booting from the selected device.

3.9 Tool menu

The Tool menu items allow you to configure options for special functions. Select an item then press <Enter> to display the submenu.

3.9.1 ASUS EZ Flash 3 Utility

This item allows you to run ASUS EZ Flash 3. When you press <Enter>, a confirmation message appears. Use the left/right arrow key to select between [Yes] or [No], then press <Enter> to confirm your choice.



For more details, refer to section **3.11.2 ASUS EZ Flash 3**.

3.9.2 ASUS User Profile

This item allows you to store or load multiple BIOS settings.

Load Profile

This item allows you to load the previous BIOS settings saved in the BIOS Flash. Key in the profile number that saved your BIOS settings, press <Enter>, and then select **Yes**.



- DO NOT shut down or reset the system while updating the BIOS to prevent the system boot failure!
 - We recommend that you update the BIOS file only coming from the same memory/CPU configuration and BIOS version.
-

Profile Name

This item allows you to key in a profile name.

Save to Profile

This item allows you to save the current BIOS settings to the BIOS Flash, and create a profile. Key in a profile number from one to eight, press <Enter>, and then select **Yes**.

Load/Save Profile from/to USB Drive

This item allows you to load or save profile from your USB drive, load and save profile to your USB drive.

3.9.3 ASUS SPD Information

This item allows you to view the DRAM SPD information.

3.9.4 ASUS Q-Installer

This item allows you to configure the Q-Installer.

3.10 Exit menu

The Exit menu items allow you to load the optimal default values for the BIOS items, and save or discard your changes to the BIOS items. You can access the EZ Mode from the Exit menu.

Load Optimized Defaults

This option allows you to load the default values for each of the parameters on the Setup menus. When you select this option or if you press <F5>, a confirmation window appears. Select **OK** to load the default values.

Save Changes & Reset

Once you are finished making your selections, choose this option from the Exit menu to ensure the values you selected are saved. When you select this option or if you press <F10>, a confirmation window appears. Select **OK** to save changes and exit.

Discard Changes & Exit

This option allows you to exit the Setup program without saving your changes. When you select this option or if you press <Esc>, a confirmation window appears. Select **Yes** to discard changes and exit.

Launch EFI Shell from USB drives

This item allows you to attempt to launch the EFI Shell application (shellx64.efi) from one of the available filesystem devices.

3.11 Updating BIOS

The ASUS website publishes the latest BIOS versions to provide enhancements on system stability, compatibility, and performance. However, BIOS updating is potentially risky. If there is no problem using the current version of BIOS, DO NOT manually update the BIOS. Inappropriate BIOS updating may result to system's failure to boot. Carefully follow the instructions in this chapter to update your BIOS when necessary.



Visit <http://www.asus.com> to download the latest BIOS file for this motherboard.

The following utilities allow you to manage and update the motherboard BIOS setup program.

1. EZ Update: Updates the BIOS in Windows® environment.
2. ASUS EZ Flash 3: Updates the BIOS using a USB flash drive.
3. ASUS CrashFree BIOS 3: Restores the BIOS using the motherboard support DVD or a USB flash drive when the BIOS file fails or gets corrupted.

3.11.1 EZ Update

The EZ Update is a utility that allows you to update the motherboard BIOS in Windows® environment.



-
- EZ Update requires an Internet connection either through a network or an ISP (Internet Service Provider).
 - This utility is available in the support DVD that comes with the motherboard package.
-

3.11.2 ASUS EZ Flash 3

ASUS EZ Flash 3 allows you to download and update to the latest BIOS through the Internet without having to use a bootable floppy disk or an OS-based utility.



Updating through the Internet varies per region and Internet conditions. Check your local Internet connection before updating through the Internet.

To update the BIOS by USB:

1. Enter the Advanced Mode of the BIOS setup program. Go to the Tool menu to select **ASUS EZ Flash 3 Utility** and press <Enter>.
2. Insert the USB flash disk that contains the latest BIOS file to the USB port.
3. Select **via Storage Device(s)**.

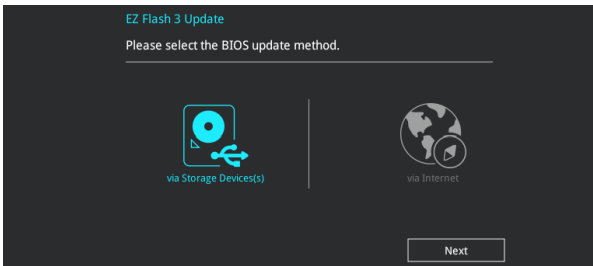

4. Press <Tab> to switch to the Drive field.
5. Press the Up/Down arrow keys to find the USB flash disk that contains the latest BIOS, and then press <Enter>.
6. Press <Tab> to switch to the Folder Info field.
7. Press the Up/Down arrow keys to find the BIOS file, and then press <Enter> to perform the BIOS update process. Reboot the system when the update process is done.

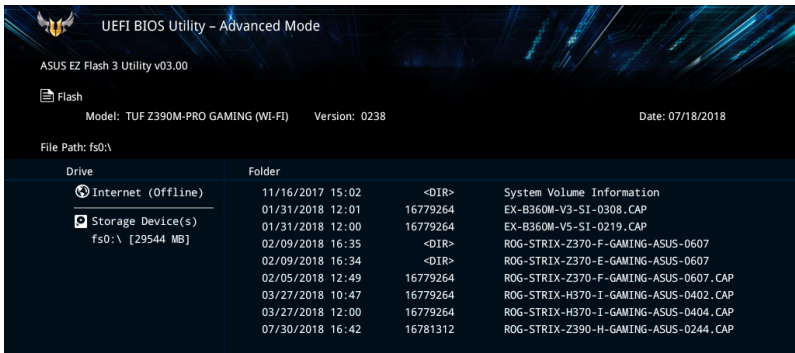



- This function can support devices such as a USB flash disk with FAT 32/16 format and single partition only.
- DO NOT shut down or reset the system while updating the BIOS to prevent system boot failure!



Ensure to load the BIOS default settings to ensure system compatibility and stability. Select the Load Optimized Defaults item under the Exit menu. See section 3.10 **Exit Menu** for details.

To update the BIOS by Internet:

1. Enter the Advanced Mode of the BIOS setup program. Go to the Tool menu to select **ASUS EZ Flash 3 Utility** and press <Enter>.
2. Select **via Internet**.

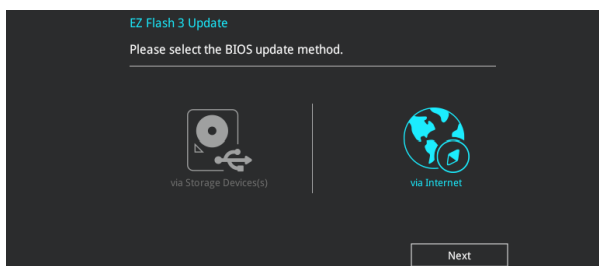

3. Press the Left/Right arrow keys to select an Internet connection method, and then press <Enter>.

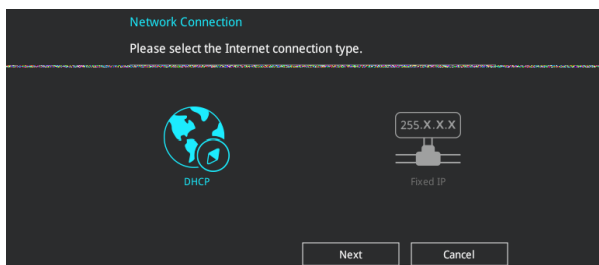

4. Follow the onscreen instructions to complete the update.
5. Reboot the system when the update process is done.



Ensure to load the BIOS default settings to ensure system compatibility and stability. Select the Load Optimized Defaults item under the Exit menu. See section 3.10 **Exit Menu** for details.

3.11.3 ASUS CrashFree BIOS 3

The ASUS CrashFree BIOS 3 utility is an auto recovery tool that allows you to restore the BIOS file when it fails or gets corrupted during the updating process. You can restore a corrupted BIOS file using the motherboard support DVD or a USB flash drive that contains the BIOS file.



The BIOS file in the motherboard support DVD may be older than the BIOS file published on the ASUS official website. If you want to use the newer BIOS file, download the file at <https://www.asus.com/support/> and save it to a USB flash drive.

Recovering the BIOS

To recover the BIOS:

1. Turn on the system.
2. Insert the motherboard support DVD to the optical drive, or the USB flash drive containing the BIOS file to the USB port.
3. The utility automatically checks the devices for the BIOS file. When found, the utility reads the BIOS file and enters ASUS EZ Flash 3 automatically.
4. The system requires you to enter BIOS Setup to recover the BIOS setting. To ensure system compatibility and stability, we recommend that you press <F5> to load default BIOS values.



DO NOT shut down or reset the system while updating the BIOS! Doing so can cause system boot failure!

RAID Support

4

4.1 RAID configurations

The motherboard comes with the Intel® Rapid Storage Technology that supports RAID 0, RAID 1, RAID 5 and RAID 10 configuration.



For more information on configuring your RAID sets, please refer to the **RAID Configuration Guide** which you can find at <https://www.asus.com/support>.

4.1.1 RAID definitions

RAID 0 (Data striping) optimizes two identical hard disk drives to read and write data in parallel, interleaved stacks. Two hard disks perform the same work as a single drive but at a sustained data transfer rate, double that of a single disk alone, thus improving data access and storage. Use of two new identical hard disk drives is required for this setup.

RAID 1 (Data mirroring) copies and maintains an identical image of data from one drive to a second drive. If one drive fails, the disk array management software directs all applications to the surviving drive as it contains a complete copy of the data in the other drive. This RAID configuration provides data protection and increases fault tolerance to the entire system. Use two new drives or use an existing drive and a new drive for this setup. The new drive must be of the same size or larger than the existing drive.

RAID 5 stripes both data and parity information across three or more hard disk drives. Among the advantages of RAID 5 configuration include better HDD performance, fault tolerance, and higher storage capacity. The RAID 5 configuration is best suited for transaction processing, relational database applications, enterprise resource planning, and other business systems. Use a minimum of three identical hard disk drives for this setup.

RAID 10 is data striping and data mirroring combined without parity (redundancy data) having to be calculated and written. With the RAID 10 configuration you get all the benefits of both RAID 0 and RAID 1 configurations. Use four new hard disk drives or use an existing drive and three new drives for this setup.

Appendix

Notices

FCC Compliance Information

Responsible Party: Asus Computer International
Address: 48720 Kato Rd., Fremont, CA 94538, USA
Phone / Fax No: (510)739-3777 / (510)608-4555

Identification of the assembled product: **INTEL 9560NGW**

Identification of the modular components used in the assembly:

Model Name: **9560NGW** FCC ID: **PD99560NG**

This device complies with part 15 of the FCC Rules. Operation is subject to the following two conditions: (1) This device may not cause harmful interference, and (2) this device must accept any interference received, including interference that may cause undesired operation.

This equipment has been tested and found to comply with the limits for a Class B digital device, pursuant to part 15 of the FCC Rules. These limits are designed to provide reasonable protection against harmful interference in a residential installation. This equipment generates, uses and can radiate radio frequency energy and, if not installed and used in accordance with the instructions, may cause harmful interference to radio communications. However, there is no guarantee that interference will not occur in a particular installation. If this equipment does cause harmful interference to radio or television reception, which can be determined by turning the equipment off and on, the user is encouraged to try to correct the interference by one or more of the following measures:

- Reorient or relocate the receiving antenna.
- Increase the separation between the equipment and receiver.
- Connect the equipment into an outlet on a circuit different from that to which the receiver is connected.
- Consult the dealer or an experienced radio/TV technician for help.

RF exposure warning

This equipment must be installed and operated in accordance with provided instructions and the antenna(s) used for this transmitter must be installed to provide a separation distance of at least 20 cm from all persons and must not be co-located or operating in conjunction with any other antenna or transmitter. End-users and installers must be provided with antenna installation instructions and transmitter operating conditions for satisfying RF exposure compliance.

Compliance Statement of Innovation, Science and Economic Development Canada (ISED)

This device complies with Innovation, Science and Economic Development Canada licence exempt RSS standard(s). Operation is subject to the following two conditions: (1) this device may not cause interference, and (2) this device must accept any interference, including interference that may cause undesired operation of the device.

Operation in the band 5150–5250 MHz is only for indoor use to reduce the potential for harmful interference to co-channel mobile satellite systems.

CAN ICES-3(B)/NMB-3(B)

Déclaration de conformité de Innovation, Sciences et Développement économique Canada (ISED)

Le présent appareil est conforme aux CNR d'Innovation, Sciences et Développement économique Canada applicables aux appareils radio exempts de licence. L'exploitation est autorisée aux deux conditions suivantes : (1) l'appareil ne doit pas produire de brouillage, et (2) l'utilisateur de l'appareil doit accepter tout brouillage radioélectrique subi, même si le brouillage est susceptible d'en compromettre le fonctionnement.

La bande 5150–5250 MHz est réservée uniquement pour une utilisation à l'intérieur afin de réduire les risques de brouillage préjudiciable aux systèmes de satellites mobiles utilisant les mêmes canaux.

CAN ICES-3(B)/NMB-3(B)

VCCI: Japan Compliance Statement

Class B ITE

この装置は、クラスB情報技術装置です。この装置は、家庭環境で使用することを目的としていますが、この装置がラジオやテレビジョン受信機に近接して使用されると、受信障害を引き起こすことがあります。

取扱説明書に従って正しい取り扱いをして下さい。

VCCI-B

KC: Korea Warning Statement

B급 기기 (가정용 방송통신기자재)

이 기기는 가정용(B급) 전자파적합기기로서 주로 가정에서 사용하는 것을 목적으로 하며, 모든 지역에서 사용할 수 있습니다.

*당해 무선설비는 전파혼신 가능성이 있으므로 인명안전과 관련된 서비스는 할 수 없습니다.

REACH

Complying with the REACH (Registration, Evaluation, Authorisation, and Restriction of Chemicals) regulatory framework, we published the chemical substances in our products at ASUS REACH website at <http://csr.asus.com/english/REACH.htm>.



DO NOT throw the motherboard in municipal waste. This product has been designed to enable proper reuse of parts and recycling. This symbol of the crossed out wheeled bin indicates that the product (electrical and electronic equipment) should not be placed in municipal waste. Check local regulations for disposal of electronic products.



DO NOT throw the mercury-containing button cell battery in municipal waste. This symbol of the crossed out wheeled bin indicates that the battery should not be placed in municipal waste.

ASUS Recycling/Takeback Services

ASUS recycling and takeback programs come from our commitment to the highest standards for protecting our environment. We believe in providing solutions for you to be able to responsibly recycle our products, batteries, other components as well as the packaging materials. Please go to <http://csr.asus.com/english/Takeback.htm> for detailed recycling information in different regions.

Regional notice for California



WARNING

Cancer and Reproductive Harm -
www.P65Warnings.ca.gov

Google™ License Terms

Copyright© 2018 Google Inc. All Rights Reserved.

Licensed under the Apache License, Version 2.0 (the “License”); you may not use this file except in compliance with the License. You may obtain a copy of the License at:

<http://www.apache.org/licenses/LICENSE-2.0>

Unless required by applicable law or agreed to in writing, software distributed under the License is distributed on an “AS IS” BASIS, WITHOUT WARRANTIES OR CONDITIONS OF ANY KIND, either express or implied.

See the License for the specific language governing permissions and limitations under the License.

NCC: Taiwan Wireless Statement

經型式認證合格之低功率射頻電機，非經許可，公司、商號或使用者均不得擅自變更頻率、加大功率或變更原設計之特性及功能。低功率射頻電機之使用不得影響飛航安全及干擾合法通信；經發現有干擾現象時，應立即停用，並改善至無干擾時方得繼續使用。前項合法通信，指依電信法規定作業之無線電通信。低功率射頻電機須忍受合法通信或工業、科學及醫療用電波輻射性電機設備之干擾。

應避免影響附近雷達系統之操作。

Japan RF Equipment Statement

屋外での使用について

本製品は、5GHz帯域での通信に対応しています。電波法の定めにより5.2GHz、5.3GHz帯域の電波は屋外で使用が禁じられています。

法律および規制遵守

本製品は電波法及びこれに基づく命令の定めるところに従い使用してください。日本国外では、その国の法律または規制により、本製品の使用ができないことがあります。このような国では、本製品を運用した結果、罰せられることがあります。当社は一切責任を負いかねますのでご了承ください。

Précautions d'emploi de l'appareil :

- a. Soyez particulièrement vigilant quant à votre sécurité lors de l'utilisation de cet appareil dans certains lieux (les avions, les aéroports, les hôpitaux, les stations-service et les garages professionnels).
- b. Évitez d'utiliser cet appareil à proximité de dispositifs médicaux implantés. Si vous portez un implant électronique (stimulateurs cardiaques, pompes à insuline, neurostimulateurs...), veuillez impérativement respecter une distance minimale de 15 centimètres entre cet appareil et l'implant pour réduire les risques d'interférence.
- c. Utilisez cet appareil dans de bonnes conditions de réception pour minimiser le niveau de rayonnement. Ce n'est pas toujours le cas dans certaines zones ou situations, notamment dans les parkings souterrains, dans les ascenseurs, en train ou en voiture ou tout simplement dans un secteur mal couvert par le réseau.
- d. Tenez cet appareil à distance du ventre des femmes enceintes et du bas-ventre des adolescents.

Simplified EU Declaration of Conformity

ASUSTek Computer Inc. hereby declares that this device is in compliance with the essential requirements and other relevant provisions of Directive 2014/53/EU. Full text of EU declaration of conformity is available at <https://www.asus.com/support/>

The WiFi operating in the band 5150-5350MHz shall be restricted to indoor use for countries listed in the table below:

Déclaration simplifiée de conformité de l'UE

ASUSTek Computer Inc. déclare par la présente que cet appareil est conforme aux critères essentiels et autres clauses pertinentes de la directive 2014/53/UE. La déclaration de conformité de l'UE peut être téléchargée à partir du site internet suivant : <https://www.asus.com/support/>

Dans la plage de fréquence 5150-5350 MHz, le Wi-Fi est restreint à une utilisation en intérieur dans les pays listés dans le tableau ci-dessous:

Vereinfachte EU-Konformitätserklärung

ASUSTek COMPUTER INC erklärt hiermit, dass dieses Gerät mit den grundlegenden Anforderungen und anderen relevanten Bestimmungen der Richtlinie 2014/53/EU übereinstimmt. Der gesamte Text der EU-Konformitätserklärung ist verfügbar unter: <https://www.asus.com/support/>

Der WLAN-Betrieb im Band von 5150-5350 MHz ist für die in der unteren Tabelle aufgeführten Länder auf den Innenbereich beschränkt:

Dichiarazione di conformità UE semplificata

ASUSTek Computer Inc. con la presente dichiara che questo dispositivo è conforme ai requisiti essenziali e alle altre disposizioni pertinenti con la direttiva 2014/53/UE. Il testo completo della dichiarazione di conformità UE è disponibile all'indirizzo: <https://www.asus.com/support/>

L'utilizzo della rete Wi-Fi con frequenza compresa nell'intervallo 5150-5350MHz deve essere limitato all'interno degli edifici per i paesi presenti nella seguente tabella:

Упрощенное заявление о соответствии европейской директиве

ASUSTek Computer Inc. заявляет, что устройство соответствует основным требованиям и другим соответствующим условиям директивы 2014/53/UE. Полный текст декларации соответствия ЕС доступен на <https://www.asus.com/support/>

Работа Wi-Fi в диапазоне частот 5150-5350 MHz должна быть ограничена использованием в помещениях для стран, перечисленных в таблице ниже:

إعلان التوافق المبسط الصادر عن الاتحاد الأوروبي

تقر شركة ASUSTek Computer Inc هذا الجهاز بتوافق مع المتطلبات الأساسية والأحكام الأخرى ذات الصلة الخاصة بتوجيه 2014/53/UE. يتوفر النص الكامل لإعلان التوافق الصادر عن الاتحاد الأوروبي على: <https://www.asus.com/support/>

يجب حصر استخدام WiFi العاملة بـ 5150-5350 MHz مجازاً فقط على الاستخدام المنزلي لبلدان المنطقة بالجنوب.

Опрощена декларация за съответствие на ЕС

С настоящото ASUSTek Computer Inc. декларира, че това устройство е в съответствие със съществените изисквания и другите приложими постановления на свързаната Директива 2014/53/ЕС. Пълният текст на ЕС декларация за съвместимост е достъпен на адрес <https://www.asus.com/support/>

WiFi, работеща в диапазон 5150-5350MHz, трябва да се ограничи до употреба на закрито за страните, посочени в таблицата по-долу:

Declaração de Conformidade UE Simplificada

ASUSTek Computer Inc. declara que este dispositivo está em conformidade com os requisitos essenciais e outras disposições relevantes relacionadas às diretivas 2014/53/UE. O texto completo da declaração de conformidade CE está disponível em <https://www.asus.com/support/>

O WiFi operando na banda 5150-5350MHz deve ser restrito para uso interno para os países listados na tabela abaixo:

Поједностављена ЕУ изјава о складности

ASUSTek Computer Inc. овим изјављује да је овај уређај складан с битним захтевима и осталим одговарајућим одредбама директиве 2014/53/ЕУ. Цјели текст ЕУ изјаве о складности доступан је на <https://www.asus.com/support/>

WiFi који ради на опсегу фреквенција 5150-5350 MHz бит ће ограничен на употребу у затвореном простору у земљама на доњем попису:

Zjednodušené prohlášení o shodě EU

Společnost ASUSTek Computer Inc. tímto prohlašuje, že toto zařízení splňuje základní požadavky a další příslušná ustanovení směrnice 2014/53/UE. Plné znění prohlášení o shodě EU je k dispozici na adrese <https://www.asus.com/support/>

V zemích uvedených v tabulce je provoz sítě Wi-Fi ve frekvenčním rozsahu 5 150 - 5 350 MHz povolen pouze ve vnitřních prostorech:

Forenklet EU-øverenstemmelseserklæring

ASUSTek Computer Inc. erklærer hermed at denne enhed er i øverenstemmelse med hovedkravene og øvrige relevante bestemmelser i direktivet 2014/53/UE. Hele EU-øverenstemmelseserklæringen kan findes på <https://www.asus.com/support/>

Wi-Fi, der bruger 5150-5350 MHz skal begrænses til indendørs brug i lande, der er anført i tabellen:

Vereenvoudigd EU-conformiteitsverklaring

ASUSTek Computer Inc. verklaart hierbij dat dit apparaat voldoet aan de essentiële vereisten en andere relevante bepalingen van Richtlijn 2014/53/UE. De volledige tekst van de EU-conformiteitsverklaring is beschikbaar op <https://www.asus.com/support/>

De WiFi op 5150-5350MHz zal beperkt zijn tot binnengebruik voor in de tabel vermelde landen:

Lihtsustatud EÜ vastavusdeklaratsioon

Käesolevaga kinnitab ASUSTek Computer Inc. et seade vastab direktiivi 2014/53/EL olulistele nõuetele ja teistele asjakohastele sätetele. EL vastavusdeklaratsiooni täistekst on saadaval veebisaidil <https://www.asus.com/support/>

Sagedusvahemikus 5150-5350 MHz töötava WiFi kasutamine on järgmistes riikides lubatud ainult siseruumides:

Eurooppa - EÜ:n vaatimustenmukaisuusvakuutus

ASUSTek Computer Inc. ilmoittaa täten, että tämä laite on direktiivin 2014/53/UE olennainen vaatimusten ja muiden asiaankuuluvien liisysten mukainen. Koko EY:n vaatimustenmukaisuusvakuutuksen teksti on luettavissa osoitteessa <https://www.asus.com/support/>

5 150 - 5 350 MHz:in taajuudella toimiva WiFi on rajoitettu sisäkäyttöön taulukossa luetteluissa maissa:

تعبیر از نسخه ساده شده بیانیه انطباقی اروپا

ASUSTek Computer Inc در اینجا اعلام می کند که این دستگاه با نیازهای اساسی و سایر مقررات مربوط به بیانیه 2014/53/UE مطابقت دارد. متن کامل پیروی از این بیانیه انطباقی اروپا در این آدرس موجود است:

<https://www.asus.com/support/>

متن کامل این آدرس: <https://www.asus.com/support/>

متن کامل این آدرس: <https://www.asus.com/support/>

Απλοποιημένη Δήλωση Συμμόρφωσης ΕΕ

Διά το παρόντος η ASUSTek Computer Inc. δηλώνει ότι αυτή η συσκευή είναι συμμόρφω με τις βασικές προϋποθέσεις και άλλες σχετικές διατάξεις της Οδηγίας 2014/53/ΕΕ. Το πλήρες κείμενο της δήλωσης συμμόρφωσης της ΕΕ είναι διαθέσιμο στη διεύθυνση <https://www.asus.com/support/>

To WiFi που λειτουργεί στη ζώνη 5150-5350MHz περιορίζεται για χρήση σε εσωτερικούς χώρους για τις χώρες που αναφέρονται στον παρακάτω πίνακα:

הצהרת אימות הרגולטורית מקוצרת עבור היחידות אירופי

ASUSTek Computer Inc. מצהירה בראת כי מכשיר זה תואם לדרישות החיוביות ולשאר הסעיפים הרלוונטיים של תקנה 2014/53/UE. ניתן לקרוא את הטקסט המלא של הצהרת האימות הרגולטורית עבור היחידות האירופי בתוכנית <https://www.asus.com/support/>

יש להגביר רשתות Wi-Fi הפועלות ברצועות התדרים 5150-5350MHz שימוש בתוך הבנים מגורים בארצות המפורסות ברשימה הבאה:

Egyezszerített EU megfelelési nyilatkozat

Az ASUSTek Computer Inc. ezennel kijelenti, hogy ez az eszköz megfelel az 2014/53/UE sz. irányelv alapvető követelményeinek és egyéb vonatkozó rendelkezéseinek. Az EU megfelelési nyilatkozat teljes szövegét a következő weboldalon tekintheti meg: <https://www.asus.com/support/>

Az 5150-5350 MHz-es sávban működő Wi-Fi beltéri használatra kell korlátozni az alábbi táblázatban felsorolt országokban:

Pernyataan Kesesuaian UE yang Disederhanakan

ASUSTek Computer Inc. dengan ini menyatakan bahwa perangkat ini memenuhi persyaratan utama dan ketentuan relevan lainnya yang terdapat pada Peraturan 2014/53/UE. Teks lengkap pernyataan kesesuaian UE tersedia di: <https://www.asus.com/support/>

WiFi yang Beroperasi pada 5150-5350 MHz akan terbatas untuk penggunaan dalam ruangan di negara yang tercantum dalam tabel

Vienkāršota ES atbilstības paziņojums

ASUSTek Computer Inc. ar šo paziņo, ka šī ierīce atbilst Direktīvas 2014/53/ES būtiskajām prasībām un citiem citiem saistošajiem nosacījumiem. Pilns ES atbilstības paziņojuma teksts pieejams šeit: <https://www.asus.com/support/>

Wi-Fi darbība 5150-5350 MHz ir jāierobežo lietošanai telpās valstīs, kuras norādītas tālāk.

Supraprastinta ES atitikties deklaracija

Šiame dokumente bendrovė „ASUSTek Computer Inc.“ pareiškia, kad šis prietaisas atitinka pagrindinius reikalavimus ir kitas susijusias Direktyvos 2014/53/ES nuostatas. Visas ES atitikties deklaracijos tekstas pateikiamas čia: <https://www.asus.com/support/>

Toliau nurodytose šalyse „WiFi“ ryšiu, veikiančiu 5 150–5 350 MHz dažniu juostoje, galima naudotis tik patalpose: Ovaj uredaj može da se koristi u državama navedenim ispod:

Forenklet EU-samsvarserklæring

ASUSTek Computer Inc. erklærer herved at denne enhed er i samsvar med hovedsagelige krav og andre relevante forskrifter i direktivet 2014/53/EU. Fullstendig tekst for EU-samsvarserklæringen finnes på: <https://www.asus.com/support/>

Wi-Fi-området 5150–5350 MHz skal begrænses til indendørs brug for landene som er opført i tabellen:

Uprzeczona deklaracja zgodności UE

Firma ASUSTek Computer Inc. niniejszym oświadcza, że urządzenie to jest zgodne z zasadniczymi wymogami i innymi właściwymi postanowieniami dyrektywy 2014/53/EU. Pełny tekst deklaracji zgodności UE jest dostępny pod adresem <https://www.asus.com/support/>

W krajach wymienionych w tabeli działanie sieci Wi-Fi w paśmie 5150–5350 MHz powinno być ograniczone wyłącznie do pomieszczeń:

Declaração de Conformidade Simplificada da UE

A ASUSTek Computer Inc. declara que este dispositivo está em conformidade com os requisitos essenciais e outras disposições relevantes da Diretiva 2014/53/UE. O texto integral da declaração de conformidade da UE está disponível em <https://www.asus.com/support/>

A utilização das frequências WiFi de 5150 a 5350 MHz está restrita a ambientes interiores nos países apresentados na tabela:

Declaratie de conformitate UE, versiune simplificată

Prin prezenta, ASUSTek Computer Inc. declară că acest dispozitiv este în conformitate cu reglementările esențiale și cu celelalte prevederi relevante ale Directivei 2014/53/UE. Textul complet al declarației de conformitate UE este disponibil la adresa <https://www.asus.com/support/>

Pentru țările listate în tabelul de mai jos, rețeaua WiFi care funcționează în banda de frecvență de 5.150-5.350 MHz trebuie utilizată doar în interior:

Pojednostavljena Deklaracija o usaglašenosti EU

ASUSTek Computer Inc. ovim izjavljuje da je ovaj uređaj usaglašen sa osnovnim zahtevima i drugim relevantnim odredbama Direktive 2014/53/EU. Ceo tekst Deklaracije o usaglašenosti EU dostupan je na lokaciji <https://www.asus.com/support/>

WiFi koji radi u frekventnom opsegu od 5150 MHz do 5350 MHz ograničen je isključivo na upotrebu u zatvorenom prostoru za zemlje navedene u tabeli ispod:

Zjednodušené vyhlásenie o zhode platné pre EÚ

Spoločnosť ASUSTek Computer Inc. týmto vyhlasuje, že toto zariadenie je v súlade so základnými požiadavkami a ďalšími príslušnými ustanoveniami smernice č. 2014/53/EU. Plné znenie vyhlásenia o zhode pre EÚ je k dispozícii na lokalite <https://www.asus.com/support/>

Činnosť WiFi v pásme 5150–5350 MHz bude obmedzená na použitie vo vnútornom prostredí pre krajiny uvedené v tabuľke nižšie:

Poenostavljena izjava EU o skladnosti

ASUSTek Computer Inc. tukaj izjavlja, da je ta naprava skladna s temeljnimi zahtevami in drugimi relevantnimi določili Direktive 2014/53/EU. Polno besedilo izjave EU o skladnosti je na voljo na <https://www.asus.com/support/>

Declaración de conformidad simplificada para la UE

Por la presente, ASUSTek Computer Inc. declara que este dispositivo cumple los requisitos básicos y otras disposiciones pertinentes de la directiva 2014/53/UE. En <https://www.asus.com/support/> está disponible el texto completo de la declaración de conformidad para la UE.

La conexión WiFi con una frecuencia de funcionamiento de 5150-5350 MHz se restringirá al uso en interiores para los países enumerados en la tabla:

Förenklad EU-försäkran om överensstämmelse

ASUSTek Computer Inc. deklarerar härmed att denna enhet överensstämmer med de grundläggande kraven och andra relevanta bestämmelser i direktiv 2014/53/EU. Fullständig text av EU-försäkran om överensstämmelse finns på <https://www.asus.com/support/>

WiFi som använder 5150-5350 MHz kommer att begränsas för användning inomhus i de länder som anges i tabellen:

ประเทศไทยกับความสอดคล้องของสหภาพยุโรปแบบย่อ

ASUSTek Computer Inc. ขอประกาศในที่นี้ว่าอุปกรณ์มีความสอดคล้องกับความต้องการที่จำเป็นและเงื่อนไขที่เกี่ยวข้องอื่น ๆ ของบทบัญญัติข้อกำหนด 2014/53/EU เฉพาะที่สมทบของประเทศไทยเท่านั้น <https://www.asus.com/support/>

การใช้งานของ WiFi ที่ 5150-5350MHz ถูกจำกัดให้ใช้ในอาคารสำหรับประเทศไทยในคราว

Basitleştirilmiş AB Uyumluluk Bildirimi

ASUSTek Computer Inc. bu aygıtın 2014/53/EU Yönergesinin temel gereksinimlerine ve diğer ilgili hükümlerine uygun olduğunu bildirir. AB uygunluk bildirimimin tam metni şu adreste bulunabilir: <https://www.asus.com/support/>

5150-5350 MHz aralındaki WiFi çalışması, tablodaki listelenen ülkeler için iç mekan kullanımla kısıtlanacaktır.

Спрощена декларація про відповідність нормам ЄС

ASUSTek Computer Inc. заявляє, що цей пристрій відповідає основним вимогам та іншим відповідним вимогам Директиви 2014 / 53 / EU. Повний текст декларації відповідності нормам ЄС доступний на <https://www.asus.com/support/>

Робота Wi-Fi на частоті 5150-5350 МГц обмежується використанням у приміщенні для країн, поданих у таблиці нижче:



| | | | | | | |
|----|----|----|----|----|----|----|
| AT | BE | BG | CZ | DK | EE | FR |
| DE | IS | IE | IT | EL | ES | CY |
| LV | LI | LT | LU | HU | MT | NL |
| NO | PL | PT | RO | SI | SK | TR |
| FI | SE | CH | UK | HR | | |

Intel® 9560 NGW output power table:

| Function | Frequency | Maximum Output Power (EIRP) |
|-----------|-------------------|-----------------------------|
| WiFi | 2400 - 2483.5 MHz | 16.63 dBm |
| | 5150 - 5350 MHz | 17.62 dBm |
| | 5470 - 5725 MHz | 17.62 dBm |
| Bluetooth | 5725 - 5850 MHz | 8.41 dBm |
| | 2400 - 2483.5 MHz | 8.73 dBm |

For the standard EN 300 440 V2.1.1, if this device operates in 5725-5875 MHz, it will be considered as a receiver category 2.

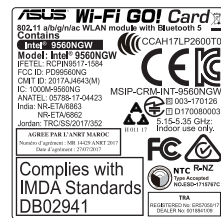

ASUS contact information

ASUSTeK COMPUTER INC.

Address 4F, No. 150, Li-Te Road, Peitou, Taipei 112, Taiwan
Telephone +886-2-2894-3447
Fax +886-2-2890-7798
Web site www.asus.com

Technical Support

Telephone +86-21-38429911
Fax +86-21-5866-8722, ext. 9101#
Online support <http://qr.asus.com/techserv>

ASUS COMPUTER INTERNATIONAL (America)

Address 48720 Kato Rd., Fremont, CA 94538, USA
Telephone +1-510-739-3777
Fax +1-510-608-4555
Web site <http://www.asus.com/us/>

Technical Support

Support fax +1-812-284-0883
Telephone +1-812-282-2787
Online support <http://qr.asus.com/techserv>

ASUS COMPUTER GmbH (Germany and Austria)

Address Harkort Str. 21-23, 40880 Ratingen, Germany
Fax +49-2102-959931
Web site <http://www.asus.com/de>
Online contact <http://eu-rma.asus.com/sales>

Technical Support

Telephone +49-2102-5789555
Support Fax +49-2102-959911
Online support <http://qr.asus.com/techserv>

