



# Table of Contents

---

<b>Chapter 1: Product Overview</b> .....	1
Package Contents .....	1
System Requirements .....	1
Network Topology Requirements .....	2
Hardware Overview .....	2
<b>Chapter 2: Installation</b> .....	5
Introduction .....	5
Hardware Installation of the UniFi AP-PRO .....	5
Hardware Installation of the UniFi AP-AC .....	8
Software Installation .....	10
<b>Chapter 3: Using the UniFi Controller Software</b> .....	13
Interface Tabs .....	13
Common Interface Options .....	13
Recent Events .....	13
Settings .....	14
Admin .....	19
<b>Chapter 4: Map Tab</b> .....	20
Adding Custom Maps .....	20
Adding a Google Map .....	21
Placing Access Points on the Map .....	22
Setting the Map Scale .....	24
<b>Chapter 5: Statistics Tab</b> .....	26
Clients .....	26
Quick Look .....	26
Current Usage - Top Access Points .....	27
Recent Activities .....	27
<b>Chapter 6: Access Points Tab</b> .....	28
<b>Chapter 7: Users Tab</b> .....	30
<b>Chapter 8: Guests Tab</b> .....	32
<b>Chapter 9: All Clients Tab</b> .....	34
<b>Chapter 10: Access Point Details</b> .....	35
Details .....	35
Users .....	36
Guests .....	37
Configuration .....	37

<b>Chapter 11: User/Guest Details</b> .....	44
Details .....	44
Statistics .....	44
History .....	45
Configuration .....	45
<b>Chapter 12: Hotspot Manager</b> .....	46
<b>Appendix A: Portal Customization</b> .....	48
Overview .....	48
Enabling Portal Customization .....	48
Viewing the Default Portal .....	48
Setup .....	48
<b>Appendix B: UniFi Discovery Utility</b> .....	50
Overview .....	50
<b>Appendix C: Specifications</b> .....	52
<b>Appendix D: Safety Notices</b> .....	54
Electrical Safety Information .....	54
<b>Appendix E: Warranty</b> .....	55
Limited Warranty .....	55
<b>Appendix F: Compliance Information</b> .....	57
FCC .....	57
Industry Canada .....	57
RF Exposure Warning .....	57
CE Marking .....	57
RoHS/WEEE Compliance Statement .....	58
<b>Appendix G: Declaration of Conformity</b> .....	59
<b>Appendix H: Contact Information</b> .....	60
Ubiquiti Networks Support .....	60

# Chapter 1: Product Overview

Thank you for purchasing the Ubiquiti UniFi Networks™ AP-PRO or AP-AC.

The UniFi AP-PRO or AP-AC works with the UniFi AP, AP-LR, AP-Outdoor, and AP-Outdoor 5G. It includes the UniFi Controller software, which allows you to manage your wireless network using a web browser.

This User Guide is for use with version 2.4 or above of the UniFi Controller software and the following UniFi Enterprise WiFi System Access Point models:

Name	Model	Wi-Fi Standards
UniFi AP-PRO	UAP-PRO	802.11a/b/g/n
UniFi AP-AC	UAP-AC	802.11a/b/g/n/ac

Unless otherwise needed to specify differences between the two models, this User Guide will refer to both as UniFi AP. Additional information is available on our website at [http://wiki.ubnt.com/UniFi\\_FAQ](http://wiki.ubnt.com/UniFi_FAQ)

The UniFi AP also includes the necessary hardware for mounting the unit on a wall or a ceiling.

The UniFi AP-PRO can be powered by any of the following:

- PoE GigE Adapter (included)
- 48V, 802.3af compliant switch
- Ubiquiti Networks TOUGHSwitch PRO, model TS-8-PRO

The UniFi AP-AC can be powered by any of the following:

- PoE GigE Adapter (included)
- PoE+ 802.3at compliant switch
- Ubiquiti Networks TOUGHSwitch PRO, model TS-8-PRO

## Package Contents

### UniFi AP-PRO

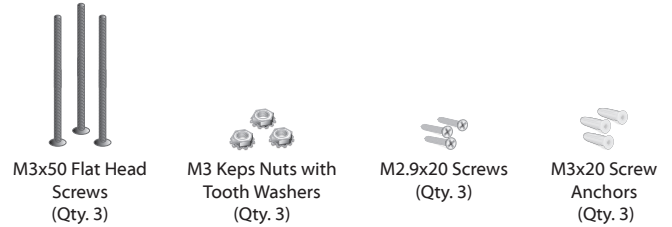
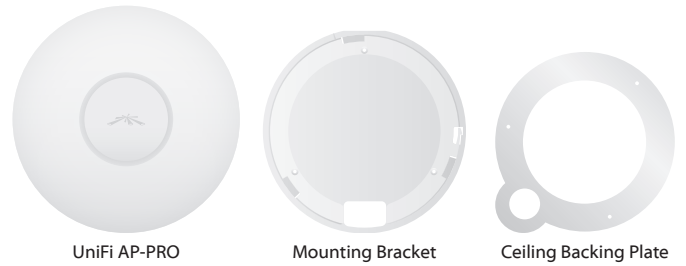

### UniFi AP-AC

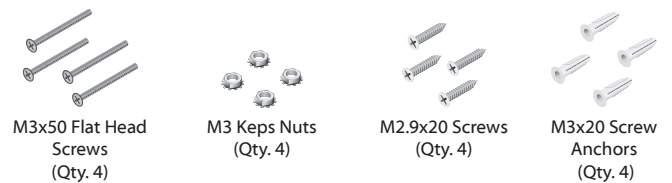
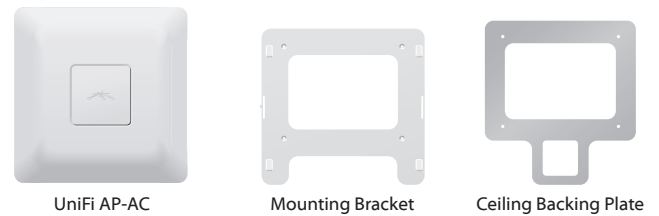

## System Requirements

- Windows Vista, Windows 7, Windows 8, or Mac OS X
- Java Runtime Environment 1.6 (or above)
- Web Browser: Mozilla Firefox, Google Chrome, or Microsoft Internet Explorer 8 (or above)

TERMS OF USE: All Ethernet cabling runs must use CAT5 (or above). It is the customer's responsibility to follow local country regulations, including operation within legal frequency channels, output power, indoor cabling requirements, and Dynamic Frequency Selection (DFS) requirements.

## Network Topology Requirements

- A DHCP-enabled network (for the wired Access Point to obtain an IP address as well as for the wireless Access Points after the deployment)
- A management station computer running the UniFi Controller software, located either onsite and connected to the same Layer-2 network, or off-site in a cloud or NOC

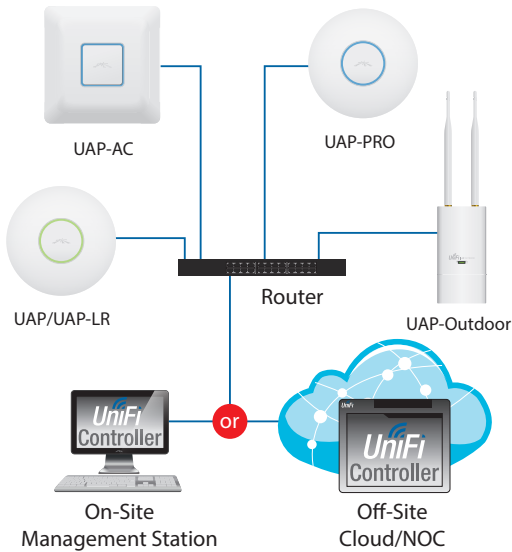

Sample Network Diagram

All UniFi APs support off-site management controllers.

## Hardware Overview

Proceed to the description for your UniFi AP model:

- **“UniFi AP-PRO” on page 2**
- **“UniFi AP-AC” on page 3**

### UniFi AP-PRO

#### LED



LED Color	Status
Flashing White	Initializing.
Steady White	Factory default, waiting to be integrated.
Alternating White/Blue	Device is busy; do not touch or unplug it. This usually indicates a process such as a firmware upgrade is taking place.
Quickly Flashing Blue	This is used to locate an AP. When you click <b>Locate</b> in the UniFi Controller software, the AP will flash. It will also display the location of the AP on the map.
Steady Blue	Indicates the device has been successfully integrated into a network and is working properly.
Steady Blue with occasional flashing	Indicates the device is in an isolated state (all WLANs are brought down until an uplink is found).

## Ports

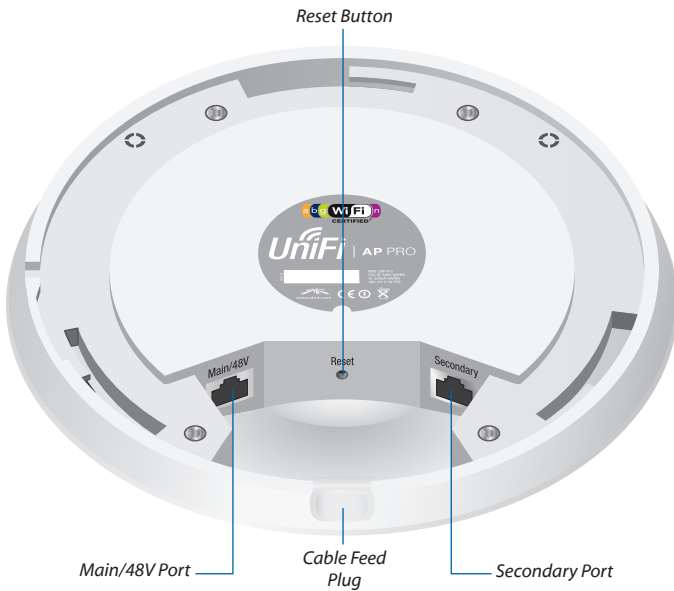

**Main/48V** The *Main/48V* port is a Gigabit Ethernet port used to connect the power and should be connected to the LAN and DHCP server. Power can be provided by any of the following:

- *PoE GigE Adapter* (included)
- 48V, 802.3af compliant switch
- Ubiquiti Networks TOUGHSwitch PRO, model TS-8-PRO

**Secondary** The *Secondary* port is a Gigabit Ethernet port used for bridging.

**Reset** The *Reset* button serves two functions:

- **Restart** It will restart the device when you press and release it quickly.
- **Restore Factory Defaults** When you press and hold it for more than 5 seconds, it will restore the device to the factory default settings.

**Cable Feed Plug** If your Ethernet cable feeds along the mounting surface, remove the *Cable Feed Plug*.

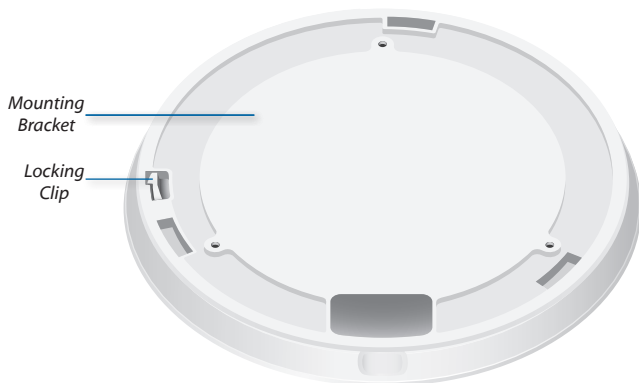

**Locking Clip** During installation, the *Locking Clip* on the *Mounting Bracket* locks into the *Locking Notch* on the UniFi AP to help prevent easy removal of the UniFi AP.

## UniFi AP-AC

### LED



LED Color	Status
Flashing white	Initializing.
Steady white	Factory default, waiting to be integrated.
Alternating white/blue	Device is busy; do not touch or unplug it. This usually indicates that a process such as a firmware upgrade is taking place.
Quickly flashing blue	This is used to locate an AP. When you click <b>Locate</b> in the UniFi Controller software, the AP will flash. It will also display the location of the AP on the map.
Steady blue	Indicates the device has been successfully integrated into a network and is working properly.
Steady blue with occasional flashing	Indicates the device is in an isolated state (all WLANs are brought down until an uplink is found).

## Ports

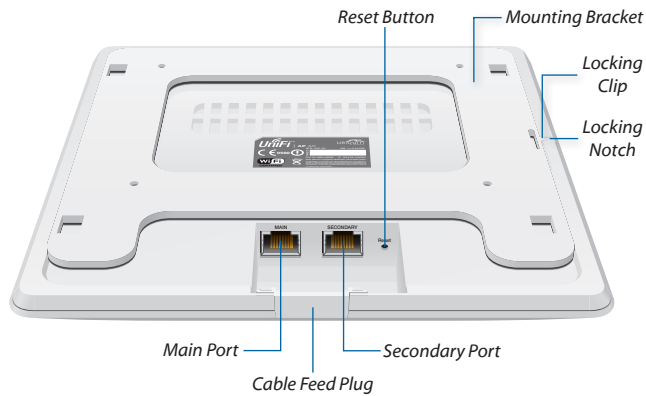

**Main** The *Main* port is a Gigabit Ethernet port used to connect the power and should be connected to the LAN and DHCP server. Power can be provided by any of the following:

- *PoE GigE Adapter* (included)
- PoE+ 802.3at compliant switch
- Ubiquiti Networks TOUGHSwitch PRO, model TS-8-PRO

**Secondary** The *Secondary* port is a Gigabit Ethernet port used for bridging.

**Reset** The *Reset* button serves two functions:

- **Restart** It will restart the device when you press and release it quickly.
- **Restore Factory Defaults** When you press and hold it for more than 5 seconds, it will restore the device to the factory default settings.

**Locking Clip** During installation, the *Locking Clip* on the *Mounting Bracket* locks into the *Locking Notch* on the UniFi AP to help prevent easy removal of the UniFi AP.

**Cable Feed Plug** If your Ethernet cable feeds along the mounting surface, remove the *Cable Feed Plug*.

## Chapter 2: Installation

### Introduction

#### Installation Requirements

- CAT5/6 cable
- Phillips screwdriver
- Drill and drill bit (6 mm for wall-mounting or 3 mm for ceiling-mounting)
- Optional: Drywall or keyhole saw (to cut 25 mm hole for Ethernet cable feed)

#### Instructions

Proceed to the hardware instructions for your UniFi AP model:

- **UniFi AP-PRO** The instructions are below.
- **UniFi AP-AC** Go to **“Hardware Installation of the UniFi AP-AC” on page 8** for instructions.

After you install the hardware, proceed to **“Software Installation” on page 10**.

### Hardware Installation of the UniFi AP-PRO

The UniFi AP-PRO can be mounted to the wall or ceiling. Perform the steps for the appropriate installation:

#### Wall Mount

1. Position the *Mounting Bracket* at the desired location on the wall with the cable feed slot pointed towards the floor.
2. Use a pencil to mark the three holes on the wall. Use a 6 mm drill bit to drill the holes.

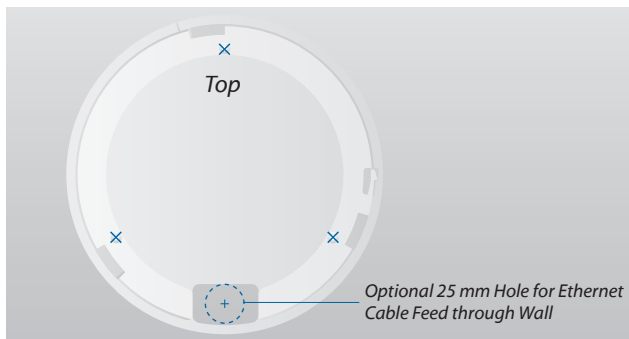

3. Follow the instruction for your Ethernet cable feed:
  - If your Ethernet cable feeds through the wall, cut or drill a circle that is approximately 25 mm in size and lines up with the cable feed slot.
  - If your Ethernet cable feeds along the wall, remove the *Plug* on the side.
4. Insert the *M3x20 Screw Anchors* into the 6 mm holes. Secure the *Mounting Bracket* to the wall by inserting the *M2.9x20 Screws* into the anchors.

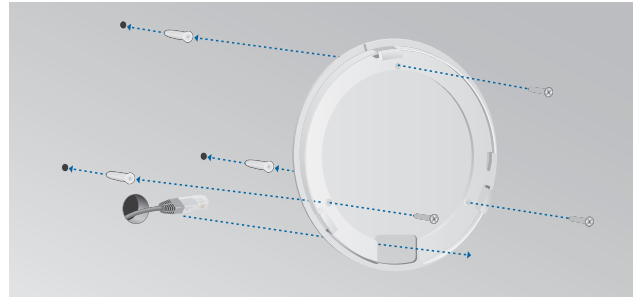

5. Connect the Ethernet cable to the *Main/48V* port on the UniFi AP-PRO.



6. Align the notch on the UniFi AP-PRO with the notch on the *Mounting Bracket*.

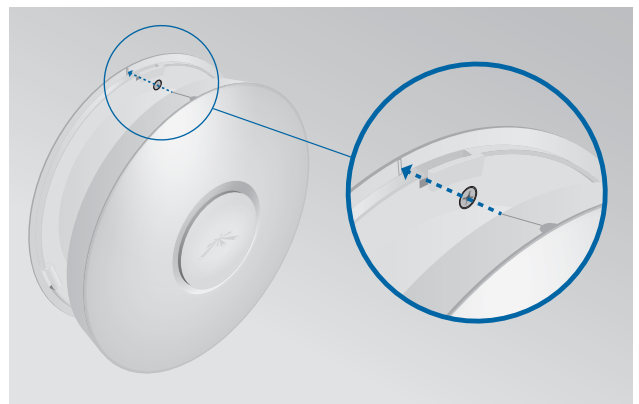



- Turn the UniFi AP-PRO clockwise until it locks into place.

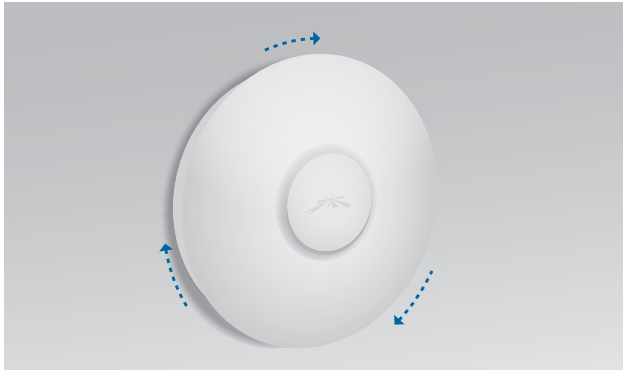

## Ceiling Mount

- Remove the ceiling tile.
- Place the *Mounting Bracket* in the center of the ceiling tile. Mark the three mounting screw holes and 25 mm hole for the Ethernet cable.

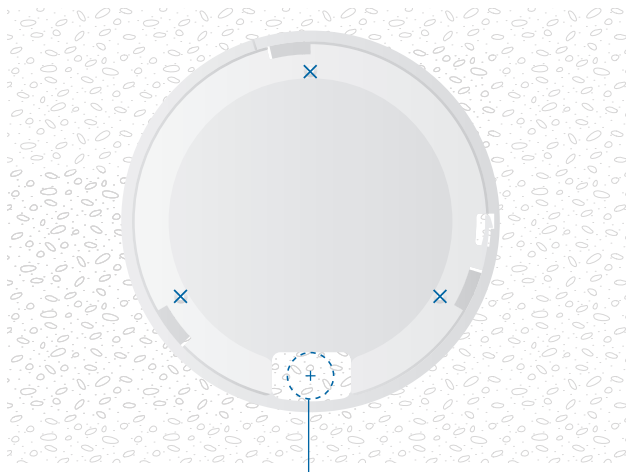

25 mm Hole for Ethernet Cable Feed

- Use a 3 mm drill bit to drill the screw holes and cut or drill the 25 mm hole for the Ethernet cable feed.

- Secure the *Mounting Bracket* to the ceiling tile using the *Ceiling Backing Plate*, *M3x50 Flathead Screws* and *M3 Keps Nuts*.
- Feed the Ethernet cable through the 25 mm hole.

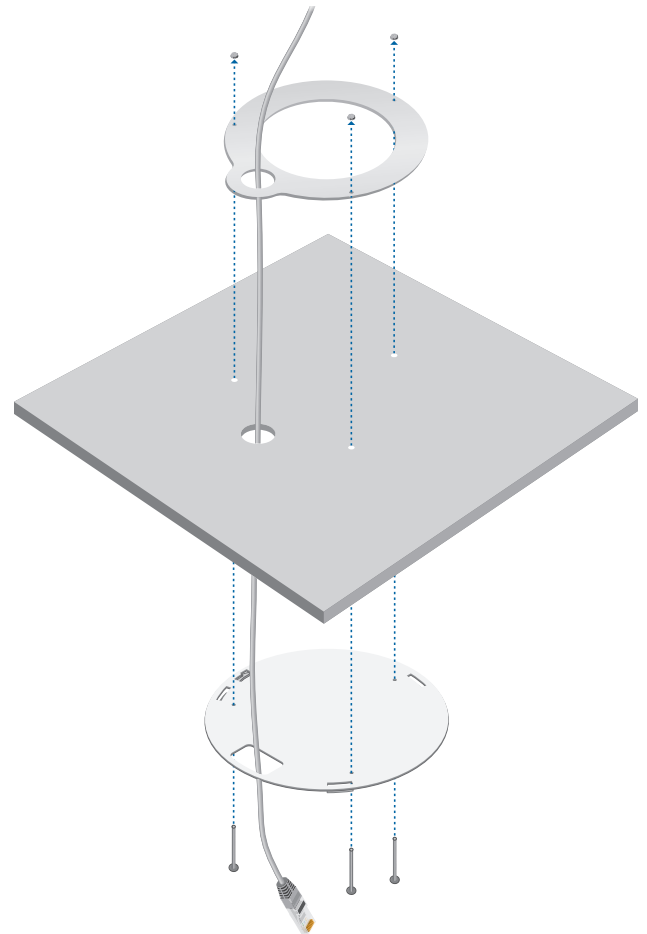

- Set the ceiling tile back into place.
- Connect the Ethernet cable to the *Main/48V* port.



- Align the notch on the UniFi AP-PRO with the notch on the *Mounting Bracket*.

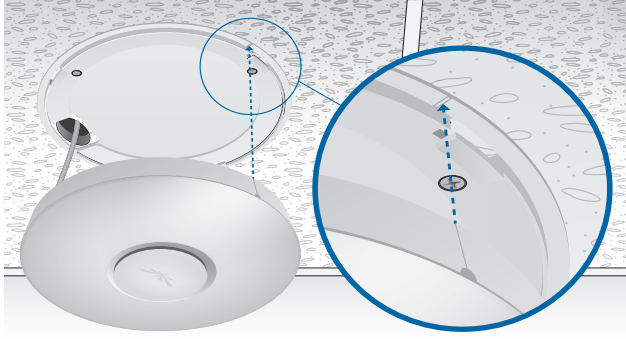

- Turn the UniFi AP-PRO clockwise until it locks into place.

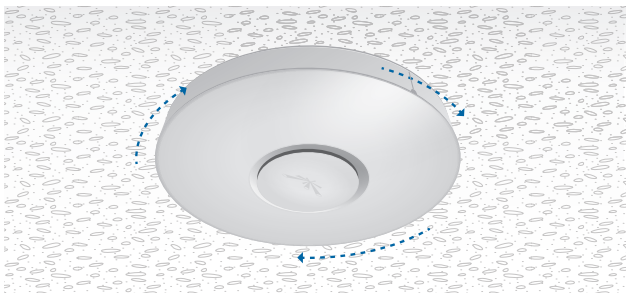

## Powering the UniFi AP-PRO

The UniFi AP-PRO can be powered directly by a compatible PoE switch or with the included *PoE GigE Adapter*.

### Connecting to a PoE Switch

Connect the other end of the Ethernet cable coming from the *Main/48V* port on the UniFi AP-PRO directly to a PoE port on one of the following:

- 48V, 802.3af compliant switch
- Ubiquiti Networks TOUGHSwitch PRO, model TS-8-PRO



TOUGHSwitch PRO Power Connection Diagram

## Connecting to the PoE GigE Adapter

- Connect the other end of the Ethernet cable coming from the *Main/48V* on the UniFi AP-PRO to the Ethernet port labeled **POE** on the *PoE GigE Adapter*.

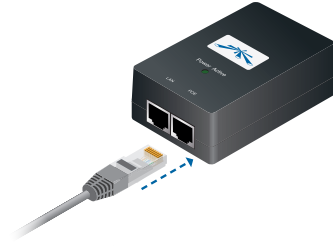

- Connect an Ethernet cable from your LAN to the Ethernet port labeled **LAN** on the *PoE GigE Adapter*.

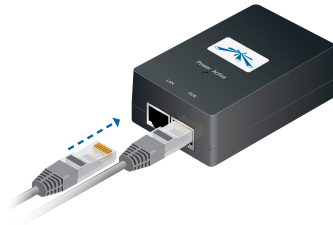

- Connect the power cord to the power port on the *PoE GigE Adapter*. Connect the other end of the power cord to a power outlet.

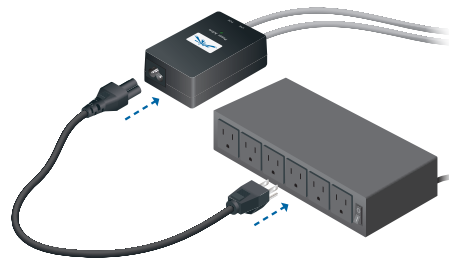

After you install the hardware, proceed to **“Software Installation” on page 10.**

## Hardware Installation of the UniFi AP-AC

The UniFi AP-AC can be mounted to the wall or ceiling. Perform the steps for the appropriate installation:

### Wall Mount

1. Position the *Mounting Bracket* at the desired location on the wall with the cable feed slot pointed towards the floor.
2. Use a pencil to mark the four mounting holes. Use a 6 mm drill bit to drill the mounting holes.

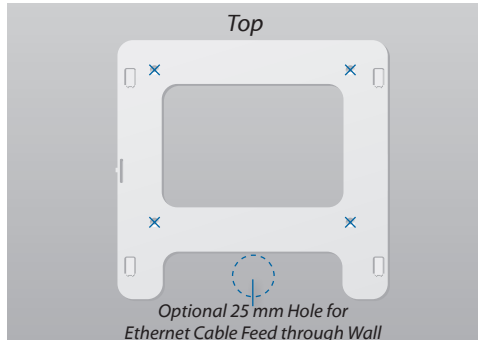

3. Follow the instruction for your type of Ethernet cable feed:
  - **Feeds Through the Wall** Cut or drill a circle approximately 25 mm in diameter, just below the bottom center of the *Mounting Bracket* (as shown above). Then feed the CAT5/6 cable through the hole.
  - **Feeds Along the Mounting Surface** Remove the *Cable Feed Plug* on the side of the UniFi AP.
4. Insert the *M3x20 Screw Anchors* into the 6 mm holes. Secure the *Mounting Bracket* to the wall by inserting the *M2.9x20 Screws* into the anchors.

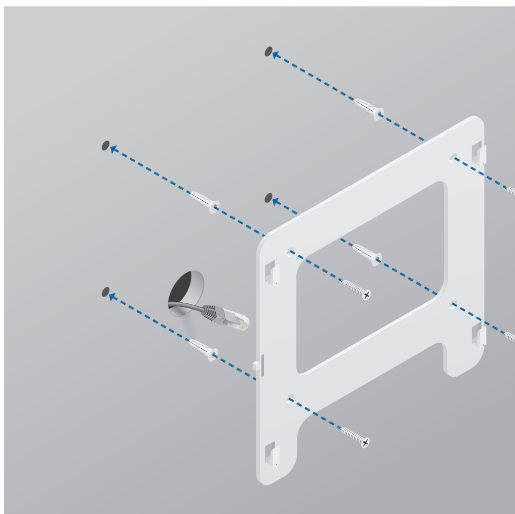

5. Connect the Ethernet cable to the *Main* port. If the feed is along the mounting surface, feed the cable through the *Cable Feed* of the UniFi AP.



6. Align the slots on the UniFi AP with the tabs on the *Mounting Bracket*.

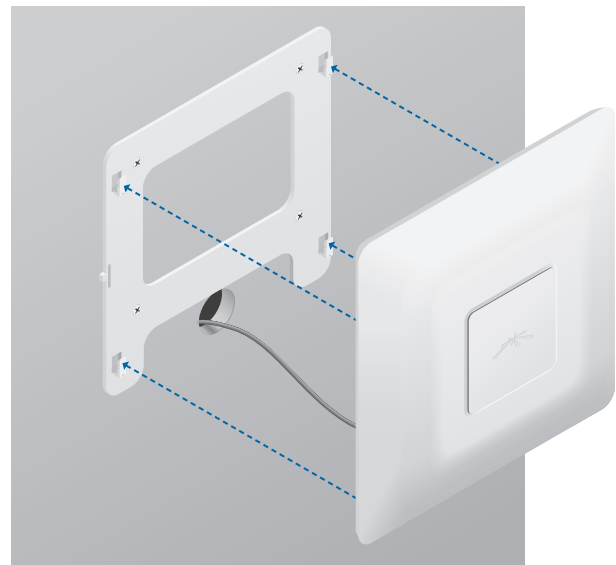

7. Slide the UniFi AP down until it locks into place.

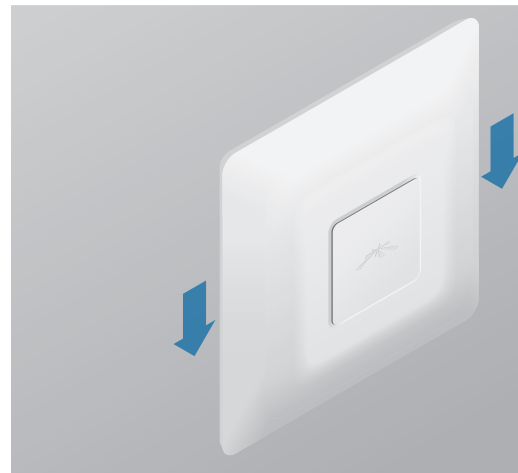

## Ceiling Mount

1. Remove the ceiling tile.
2. Place the *Ceiling Backing Plate* in the center of the ceiling tile. Mark the four mounting screw holes and 25 mm hole for the Ethernet cable feed.

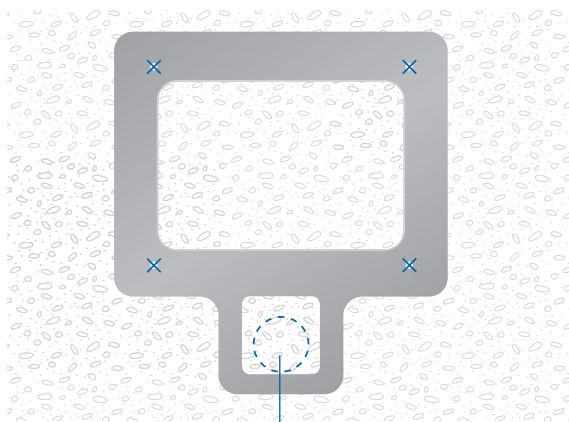

25 mm Hole for Ethernet Cable Feed

3. Use a 3 mm drill bit to drill the screw holes, and cut or drill the hole for the Ethernet cable feed.
4. Secure the *Mounting Bracket* to the ceiling tile using the *Ceiling Backing Plate*, *M3x50 Flathead Screws*, and *M3 Keps Nuts*.
5. Feed the Ethernet cable through the 25 mm hole.

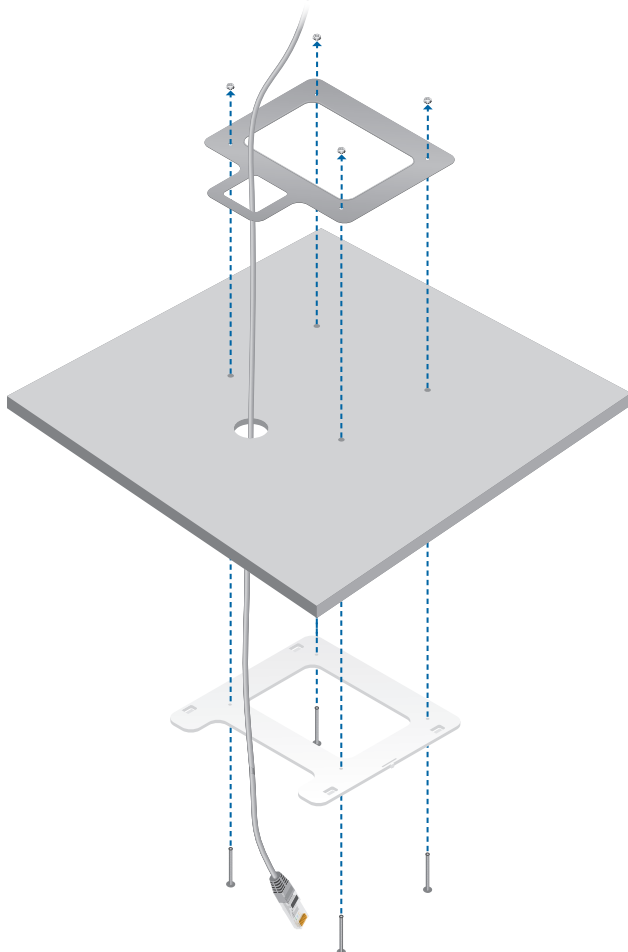

6. Set the ceiling tile back into place.
7. Connect the Ethernet cable to the *Main* port.

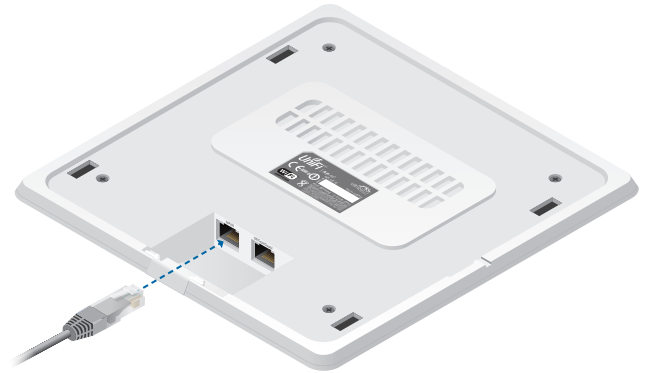

8. Align the slots on the UniFi AP with the tabs on the *Mounting Bracket*.

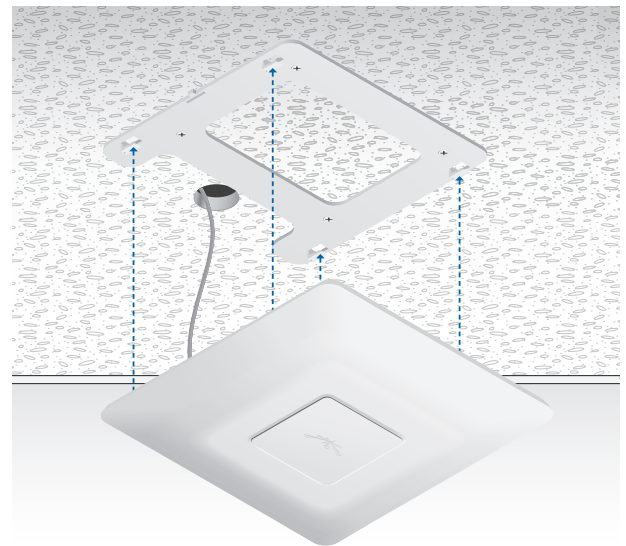

9. Slide the UniFi AP down until it locks into place.

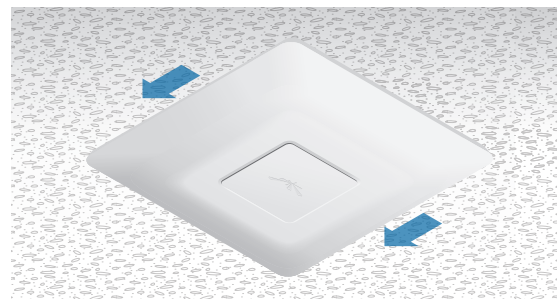

## Powering the UniFi AP-AC

The UniFi AP-AC can be powered directly by a compatible PoE switch or with the included *PoE GigE Adapter*.

### Connecting to a PoE Switch

Connect the other end of the Ethernet cable coming from the *Main* port on the UniFi AP directly to a PoE port on one of the following:

- PoE+ 802.3at compliant switch
- Ubiquiti Networks TOUGHSwitch PRO, model TS-8-PRO

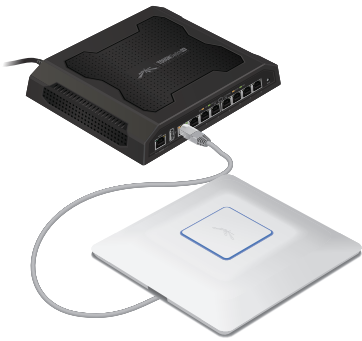

TOUGHSwitch PRO Power Connection Diagram

### Connecting to the PoE GigE Adapter

1. Connect the other end of the Ethernet cable coming from the *Main* port on the UniFi AP to the Ethernet port labeled **POE** on the *PoE GigE Adapter*.

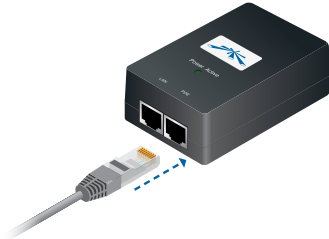

2. Connect an Ethernet cable from your LAN to the Ethernet port labeled **LAN** on the *PoE GigE Adapter*.

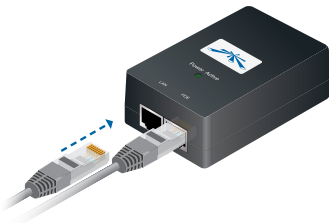

3. Connect the power cord to the power port on the *PoE GigE Adapter*. Connect the other end of the power cord to a power outlet.

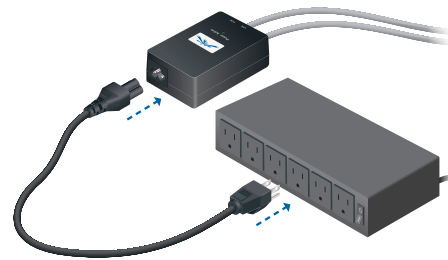

After you install the hardware, proceed to the next section, *Software Installation*.

## Software Installation

Insert the UniFi Controller software CD into your CD-ROM drive and follow the instructions for your specific computer type.

### Mac Users

1. Click the **Install** icon.



2. Click **Continue** and follow the on-screen instructions to install the software.

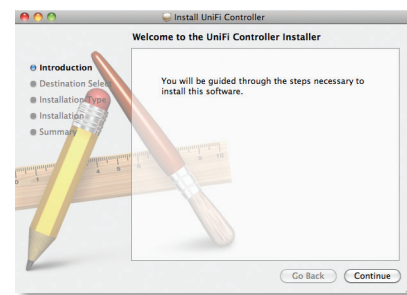

- Go to **Go > Applications** and double-click the *UniFi* icon.

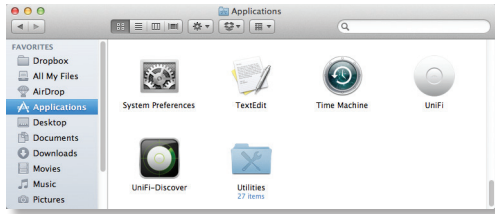

Proceed to the section, *Configuring the UniFi Controller Software*, in the next column.

## PC Users

- Launch **UniFi-installer.exe**.
- Click **Install**.

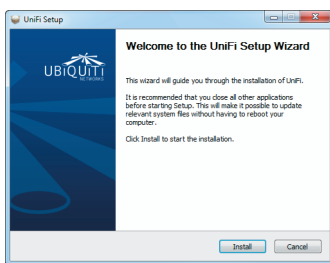

- If your computer doesn't have Java 1.6 or above installed, you will be prompted to install it. Click **Install** to continue.

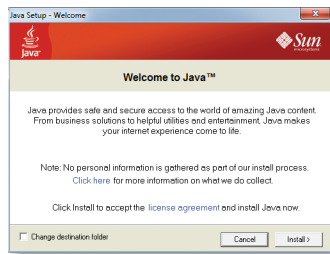

- Click **Next**.

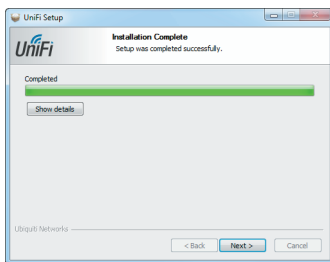

- Ensure that the *Start UniFi Controller after installation* option is checked and click **Finish**.

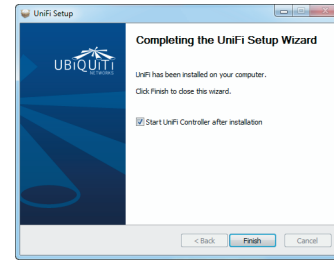

**Note:** The UniFi Controller software can also be launched from **Start > All Programs**.

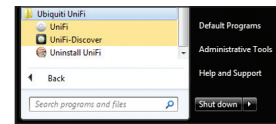

## Configuring the UniFi Controller Software

- The UniFi Controller software startup will begin. Click **Launch a Browser to Manage Wireless Network**.



- Select your language and country. Alternatively, you click **restore from a previous backup** to use a file that contains your backup settings. Click **Next**.

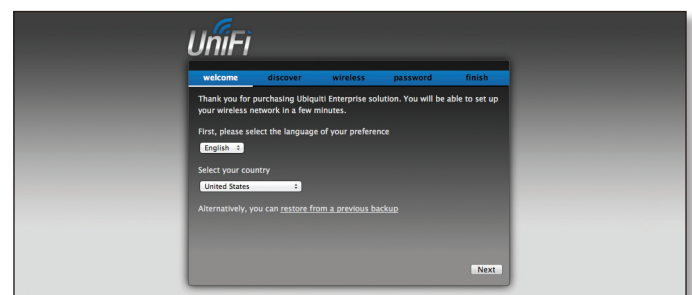

**Note:** U.S. product versions are locked to the U.S. Country Code to ensure compliance with FCC regulations.

3. Select the devices that you want to configure and click **Next**.

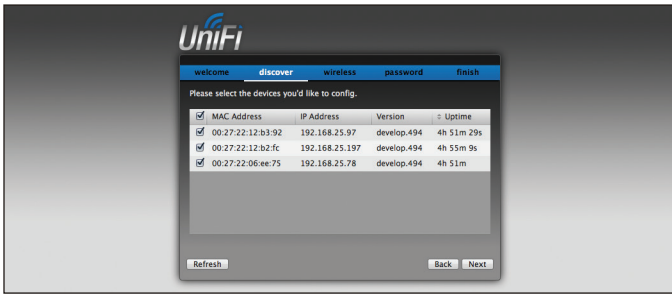

4. The UniFi Installation Wizard will create a secure primary wireless network for your devices. Perform the following steps:



- Enter the wireless network name (SSID) in the *Secure SSID* field.
  - Enter a passphrase to be used for your primary network in the *Security Key* field.
  - To enable guest access, select **Enable Guest Access**, and enter a guest network name in the *Guest SSID* field.
  - Click **Next**.
5. Enter an admin name in the *Admin Name* field and password in the *Password* field to use when accessing the management interface. Confirm your password in the *Confirm* field. Click **Next**.

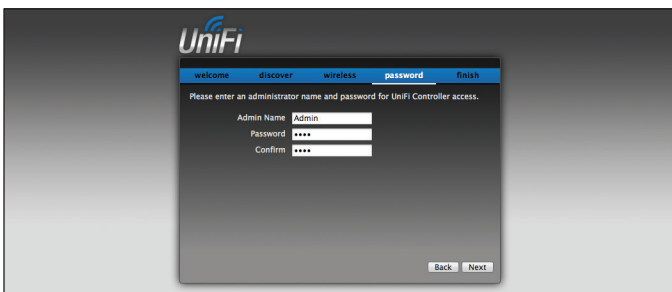

6. Review your settings. Click **Finish** to save your settings or click *Back* to make changes. Once the wizard is finished, the browser will be redirected to the management interface.



Congratulations, your wireless network is now configured. A login screen will appear for the UniFi Controller management interface. Enter the admin name and password that you created and click **Login**.



Proceed to the next chapter for information on using the UniFi Controller software.

## Chapter 3: Using the UniFi Controller Software

The UniFi Controller software that comes with your UniFi AP has a browser-based interface for easy configuration and management.

To access the interface, perform the following steps:

1. Launch the UniFi Controller application if hasn't already been started.
  - Mac users: **Go > Applications > UniFi**
  - Windows users: **Start > All Programs > Ubiquiti UniFi.**
2. The UniFi login screen will appear. Enter the admin name and password in the appropriate fields and click **Login**.



### Interface Tabs

The UniFi software consists of six primary tabs. This User Guide covers each tab with a chapter. For details, on a specific tab, refer to the appropriate chapter.

- **“Map Tab” on page 20**
- **“Statistics Tab” on page 26**
- **“Access Points Tab” on page 28**
- **“Users Tab” on page 30**
- **“Guests Tab” on page 32**
- **“All Clients Tab” on page 34**

### Common Interface Options

The common interface options are accessible from all tabs in the UniFi interface.



### Access Points

- **connected** Drop-down clickable list of all of the Access Points that are online.
- **disconnected** Displays a list of Access Points that were previously online but are no longer accessible.
- **pending** Drop-down clickable list of all of the Access Points that are not yet managed but are available for management.

### Stations

- **users** Displays the total number of users connected to the primary network.
- **guests** Displays the total number of users connected to the guest network.

### Recent Events

Displays a list of recent events including the date and time the event occurred and the details of the event. The User and Access Point names are clickable links.

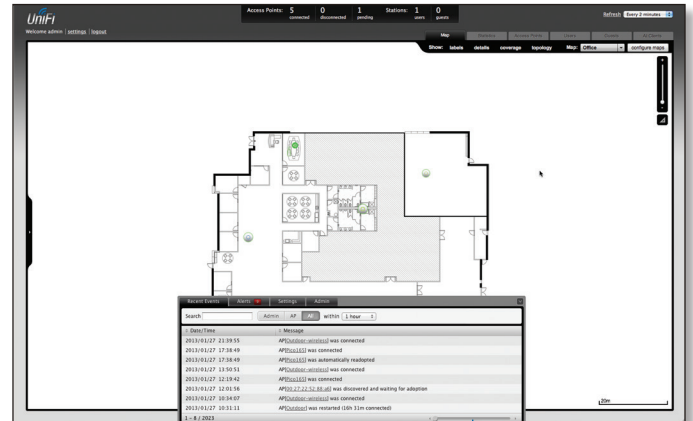

**Event Slider** Move the slider right and left to navigate between pages of events.

**Search** You can enter text that you want to search for. Simply begin typing; there is no need to press *Enter*.

**Admin** Show all of the recent events for the administrator.

**AP** Show all of the recent events for the AP.

**All** Show all of the recent events.

**within** Select the time period you want to filter.

### Clicking on an Event Device Link

The event messages have clickable links [in brackets underlined in gray text] for AP (see **“Access Point Details” on page 35**), User, and Guest (see **“User/Guest Details” on page 44**). Details vary based on the selection.



## Alerts

Important events are displayed in the alerts window. The date and time of the event and the message are displayed.

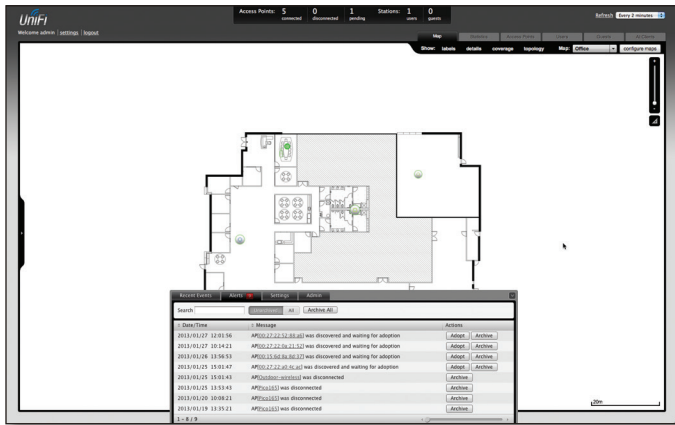

**Search** You can enter text that you want to search for. Simply begin typing; there is no need to press *Enter*.

**Unarchived** Show all of the alert messages that have not been archived.

**All** Show all of the alert messages.

**Archive All** Archive all of the alert messages displayed on the screen.

**Adopt** Click to adopt an Access Point that is waiting for adoption.

**Archive** Archive the selected alert message.

## Settings

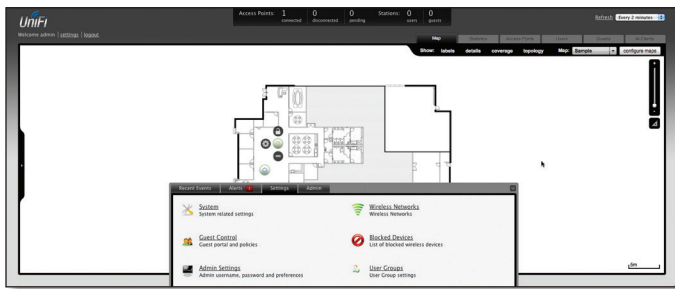

**System** System related settings.



**Guest Control** Guest portal and policies.



**Wireless Networks** Wireless networks.



**Blocked Devices** List of blocked wireless devices.



**Admin Settings** Admin username, password, and preferences.



**User Groups** User Group settings.

## Settings > System

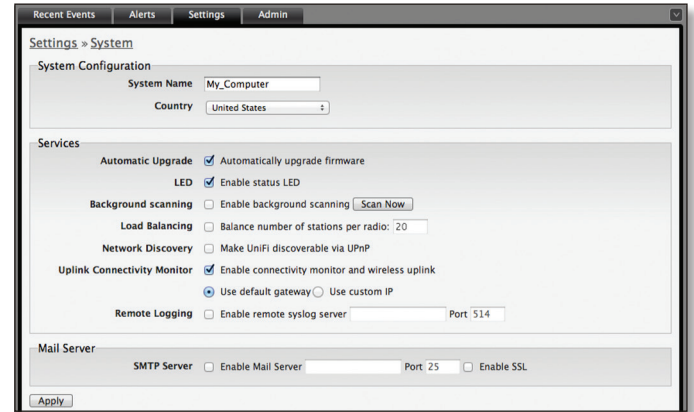

### System Configuration

**System Name** Editable field with the system name.

**Country** Select your country from the drop-down list.

### Services

**Automatic Upgrade** When enabled, this option will automatically upgrade your firmware when an update is available.

**LED** When enabled, the LED on the Access Point will light up. When disabled, the LED will turn off.

**Background Scanning** When this option is enabled, all managed Access Points will scan in the background for “Rogue Access Points” – third-party or UniFi Access Points that are being managed by another instance of the UniFi Controller software. This option is disabled by default.

- **Scan Now** When clicked, all managed Access Points will scan across all maps for two to three seconds. New Access Points in their default state will appear under *Access Points > Pending*.

**Load Balancing** Sets a desired number of clients per AP. While an AP will allow more clients to connect, it will start to look at those with lower signals and disconnect them.



**Note:** The UniFi AP-AC does not support load balancing for the initial release, but it will with a future firmware upgrade.

**Network Discovery** When enabled, this option allows UniFi to be discoverable via UPnP. This option is disabled by default.

**Uplink Connectivity Monitor** It monitors the uplinks of the managed Access Points, either wired or wireless, by checking to see if the gateway/custom IP can be reached. The monitor and wireless uplink capability are enabled by default.

- **Use default gateway** *Use default gateway* is selected by default; all managed Access Points will use the gateway of the Access Point that is providing IP information, either by DHCP or Static designation.
- **Use custom IP** Select **Use custom IP** to specify an IP address; all managed Access Points will use the IP address you enter in the *Uplink IP address* field.

**Remote Logging** Enable to define a remote syslog server. Enter the IP address and port of the syslog server.

Click **Apply** to save any changes that you have made.

### Mail Server

When enabled, UniFi will send email alerts when triggered (Pending Access Points and Disconnected Access Points) to the administrator email address specified under *Settings > Admin Settings > Admin Preferences > Email Alert*.

**SMTP Server** Enable by selecting the checkbox and entering the outgoing (SMTP) mail server name. Optionally, you may enable Secure Sockets Layer (SSL) to provide communication security over the Internet. The port number will automatically change to 465.

**Enable authentication** Enable by selecting the checkbox and entering the username and password required by the mail server.

**Specify sender address** Enable by selecting the checkbox and entering the email address that will appear as the sender of the email alert.

**Test SMTP Server** Enter an email address and click **Send** to test the mail server setup.

**Apply** Click **Apply** to save changes.

### Settings > Guest Control

### Guest Policies

**Guest Portal** This option is disabled by default. When disabled, guests can access the Internet without entering a password or accepting Terms of Use. When this option is enabled, you can control the *Guest Portal*.

**Authentication** When the Guest Portal is enabled, the authentication options will appear. There are four different authentication methods available:

- **No authentication** When this option is selected, guests are not required to log in, but must accept the Terms of Use. When you select *No authentication*, you must select *Guest Policy* under *Settings > Wireless Networks > SSID > Edit > Wireless Configurations* in order to enforce selection of the Terms of Use by the guest.

- **Simple Password** When this option is selected, guests are required to enter the simple password and accept the Terms of Use. When you select *Simple Password*, you must select *Guest Policy* under *Settings > Wireless Networks > SSID > Edit > Wireless Configurations* in order to enforce entry of the password and selection of the Terms of Use by the guest.

- **Hotspot** When selected, enables *Hotspot* functionality including the ability to customize portal login pages and bill customers using major credit cards or via PayPal™. When you select *Hotspot*, you must select:

- **Voucher** or **Payment** in the *Hotspot* section as a method of Hotspot authorization
- **Guest Policy** to enforce entry of voucher, payment, and Terms of Use by the guest (Go to *Settings > Wireless Networks > Name\_of\_wireless\_network > Edit > Wireless Configurations*.)

- **External Portal Server** If using an external server to host a custom guest portal, enter the IP address in the *Custom Portal > IP Address* box using the following format: 192.168.0.0.

- **Guest Password** (Option only available when using *Simple Password* authentication) Enter a password that guests must enter before accepting the Terms of Use and connecting to the Internet.
- **Expiration** (Option only available when using *No authentication* or *Simple Password* authentication) Allows the specification of guest login expiration after a designated period of time. Options include: *8 hours, 24 hours, 2 days, 3 days, 4 days, 7 days,* and *User-defined*, which can be designated in *minutes, hours,* and *days*.
- **Custom Portal** (Option only available when using *External Portal Server* authentication) Enter the IP address using the following format: 192.168.0.0.
- **Landing Page** (Option only available when using *No authentication, Simple Password,* or *Hotspot* authentication) The landing page is the page where guests are redirected after accepting the Terms of Use. There are two options available:
  - **Redirect to the original URL** When this option is selected, guests are directed to the URL they requested after accepting the Terms of Use.
  - **Promotional URL** When this option is selected, guests are redirected to the URL that you specify here after accepting the Terms of Use. Specify the URL with `http://` in front of the web address. Example: `http://www.ubnt.com`
- **Portal Customization** (Option only available when using *No authentication, Simple Password,* or *Hotspot* authentication) When enabled, allows customized portal pages to appear in place of default login pages. See **“Portal Customization” on page 48** for details on setting up custom portal pages.
- **Portal URL Hostname** Allows the designation of a hostname for the portal URL in place of the default IP address. Paired with a SSL certificate, ensures site certificates are displayed as trusted in the guest browser. Example: `www.ubnt.com`

## Hotspot

The Hotspot options are only visible when *Hotspot* authentication is selected.

- **Voucher** When selected, vouchers (including distributable code, duration values, and use restrictions) can be created using *Hotspot Manager* (see **“Hotspot Manager” on page 46**).
- **Payment** When enabled, allows payment-based authentication to be set up with your **PayPal Website Payments Pro** account. Payments and Transactions can be managed using *Hotspot Manager* (see **“Hotspot Manager” on page 46**).
- **PayPal** PayPal account details are entered here:
  - **Username** Enter the corresponding Username.
  - **Password** Enter the corresponding Password.
  - **Signature** Enter the corresponding Signature for the PayPal account to be used for receiving payments.

- **Use Paypal Sandbox** For PayPal testing purposes, enable this option and click **Apply Sandbox Account** to set up/access your **PayPal Sandbox Test Environment**.
- **Hotspot Operator** Click **Go to Hotspot Manager** to manage *Wireless Guests, Payments/Transactions, Vouchers,* and *Operator Accounts*. See **“Hotspot Manager” on page 46**.
- **Apply** Click **Apply** to save changes.

When logging in with *No authentication*, guests will be required to accept the Terms of Use before gaining access to the Internet.

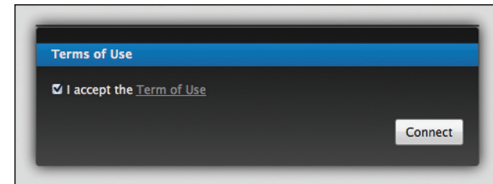

When logging in with *Simple Password* authentication, guests will be required to enter the *Guest Password* and accept the Terms of Use before gaining access to the Internet.

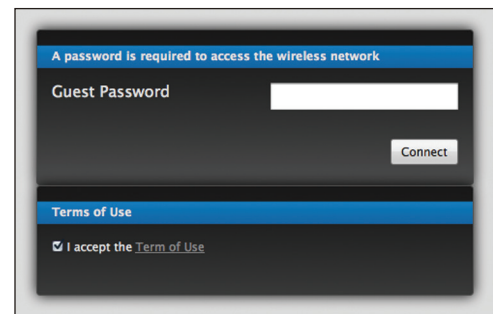

When logging in with Voucher-based *Hotspot* authentication, guests will be required to enter the voucher number and accept the Terms of Use before gaining access to the Internet.

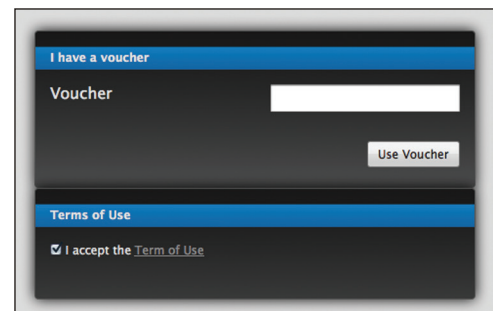

When logging in with Payment-based *Hotspot* authentication, guests will be required to select the package type, click the payment choice, and accept the Terms of Use before gaining access to the Internet.

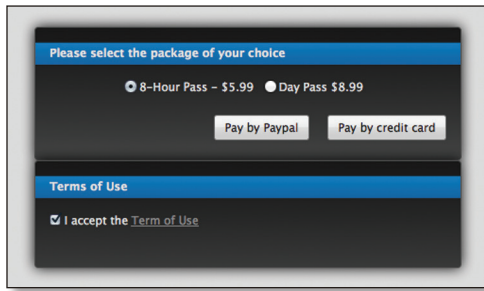

### Access Control

**Restricted Subnets** Enter any subnets that you don't want guests to be able to access.

**Apply** Click **Apply** to save changes.

### Settings > Admin Settings

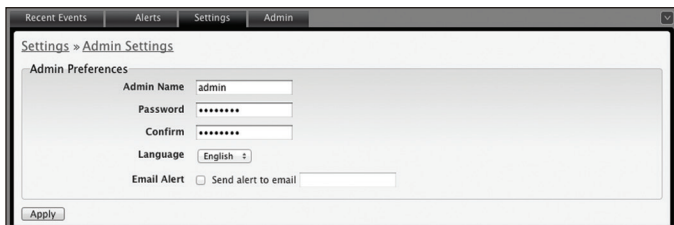

**Admin Name** Displays the current admin name used to log in. To change the admin name, simply enter a new name and click **Apply**.

**Password** A new password can be entered in this field. Ensure that you enter the password again in the *Confirm* field and then click **Apply** to save your new password.

**Confirm** Used to confirm your new password.

**Language** Selects the language for use in the interface.

**Email Alert** Select to enable email alerts and enter the administrator email address in the *Send alert to email* box. See **"Mail Server" on page 15** for information on setting up the outgoing (SMTP) mail server.

**Apply** Click **Apply** to save changes.

### Settings > Wireless Networks

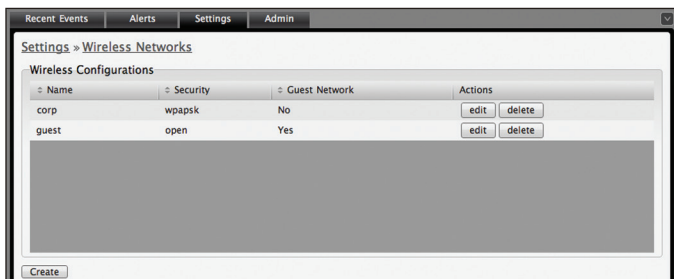

### Wireless Configurations

**Name** Displays the wireless network name (SSID).

**Security** Displays the type of security being used on your wireless network.

**Guest Network** Indicates whether the network is a guest network.

**Actions** Select an action button to perform the desired action:

- **Edit** Select to make changes to the wireless network settings.
- **Delete** Select to delete the wireless network.

### Wireless Configuration

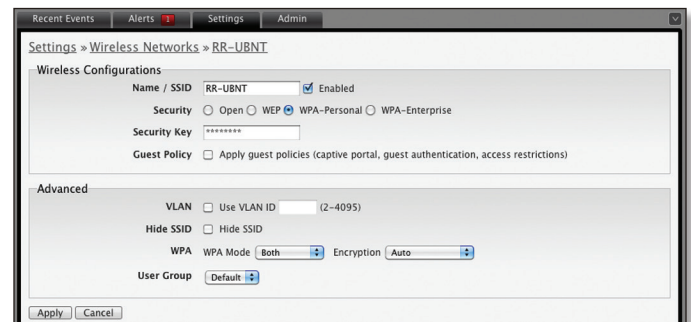

• **Name/SSID** Allows you to edit the wireless network name (SSID).

• **Security** Selects the type of security to use on your wireless network.

- **Open** This option is typically only used on the Guest network. When enabled, wireless network access is open to anyone without needing a password.

- **WEP** WEP (Wired Equivalent Privacy) is the oldest and least secure security algorithm. WPA security methods should be used when possible.

• **WEP Key** Enter a WEP encryption key in hexadecimal format. You can enter a 64-bit or 128-bit key:

Type	Hex
64-bit	10 Hexadecimal Characters (0-9, A-F, or a-f) Example: <b>00112233AA</b> Note: You can use 5 printable characters, which will be translated to the corresponding HEX code.
128-bit	26 Hexadecimal Characters (0-9, A-F, or a-f) Example: <b>00112233445566778899AABBCC</b> Note: You can use 13 printable characters, which will be translated to the corresponding HEX code.

• **Key Index** Specifies the Index of the WEP Key used. Four different WEP keys can be configured at the same time, but only one is used. The effective key is set by choosing 1, 2, 3 or 4.

- **WPA-Personal** WPA™ or Wi-Fi Protected Access was developed as an encryption method stronger than WEP. WPA-Personal requires a passphrase to connect to the wireless network.
  - **Security Key** Enter the passphrase that users will use to connect to the wireless network.
- **WPA-Enterprise** WPA Enterprise uses a RADIUS server to authenticate users on the wireless network.
  - **IP Address** This is where the IP address of the RADIUS server is specified.
  - **Port** The port number is entered here. By default it is 1812.
  - **Password** The password used to authenticate on the RADIUS server is entered here.
- **Guest Policy** Select this option to enable guest access policies on this wireless network.

**Advanced**

- **VLAN** To use a VLAN, select **Use VLAN ID** and enter the port number.
- **Hide SSID** Select this option if you don't want the SSID to be broadcast.
- **WPA** Defines supported WPA and encryption methods.
- **User Group** Allows assignment of wireless users to a specific user group.

Click **Apply** to save any changes that you have made. Click **Cancel** to discard changes.

**Settings > Blocked Devices**

Displays the list of blocked wireless devices.

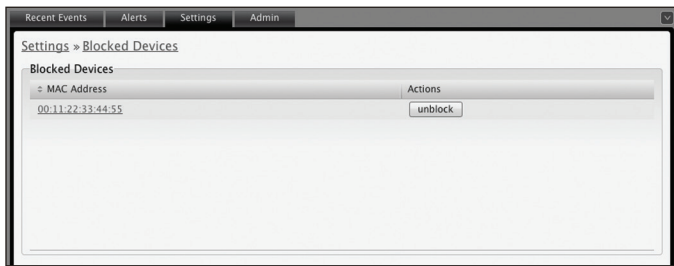

**Unblock** Click to unblock a wireless device. See **“User/Guest Details” on page 44** for information on blocking wireless devices.

**Settings > User Groups**

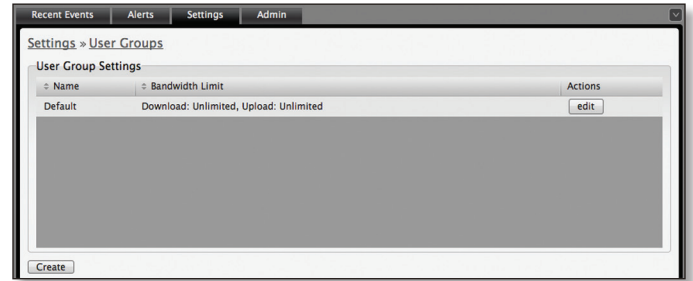

**Create** Click to create a new user group.

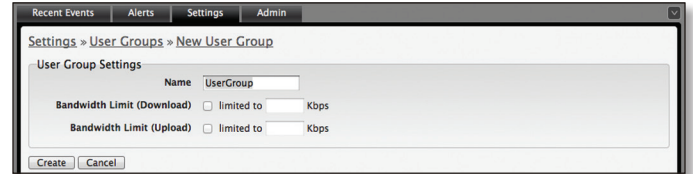

- **Name** Enter a descriptive user group name.
- **Bandwidth Limit (Download)** When selected, allows the designation of a download bandwidth limit in Kbps.
- **Bandwidth Limit (Upload)** When selected, allows the designation of an upload bandwidth limit in Kbps.
  - **Create** Click to create a user group.
  - **Cancel** Click to cancel user group creation.

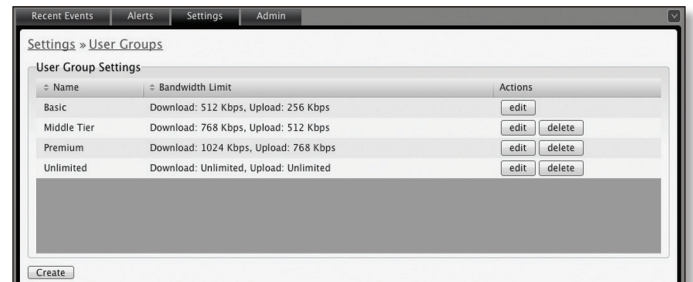

**Edit** Click to change the name or bandwidth settings of the user group.

**Delete** Click to delete the user group.

See **“Configuration” on page 45** for information on the application of User Groups to Users/Guests.

# Admin

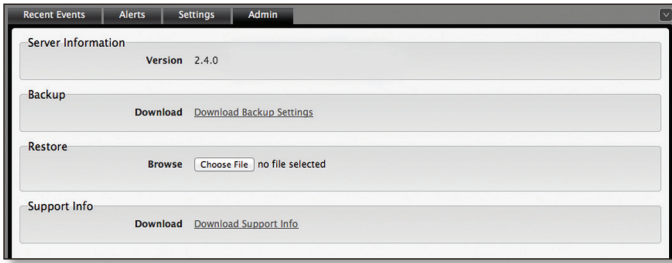

The *Admin* tab displays server version information, allows system backups to be created and downloaded, allows system restoration from backup files, and allows configuration information to be downloaded to assist in support issues.

## Server Information

**Version** The software version is displayed here. If there is an update, UniFi will automatically download it and display it here.

## Backup

**Download Backup Settings** Click to download a file that contains all of your settings so you can restore them later if you choose.

## Restore

**Choose File** Select this option to restore settings from a backup file that you've already downloaded.

## Support Info

**Download Support Info** Select this option to download a file to your computer with information about your configuration that can be emailed to our support team.



## Chapter 4: Map Tab

The UniFi Controller software allows you to upload custom map images of your location(s) or use Google Maps™ for a visual representation of your wireless network. When you initially launch the UniFi Controller application, a default map is displayed.

### Adding Custom Maps

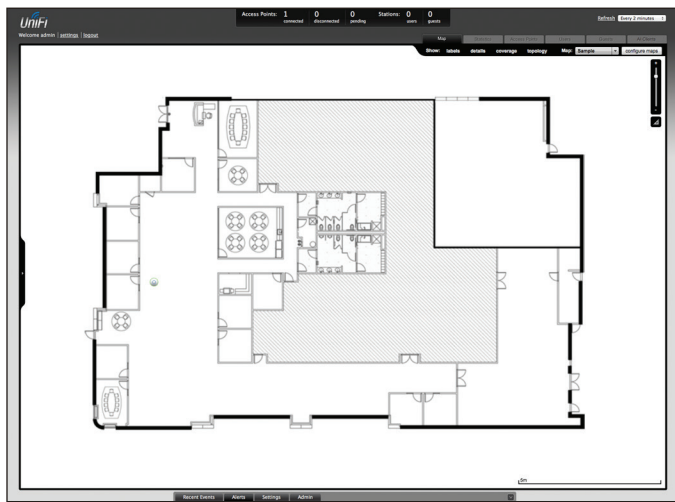

To add a custom map, you must first create the image using an illustration, image editing, or blueprint application that exports .jpg, .gif, or .png file formats.

Once you've created the map, you can upload it to the UniFi Controller software by performing the following steps:

1. Click **Configure Maps**.

*Configure Maps button*

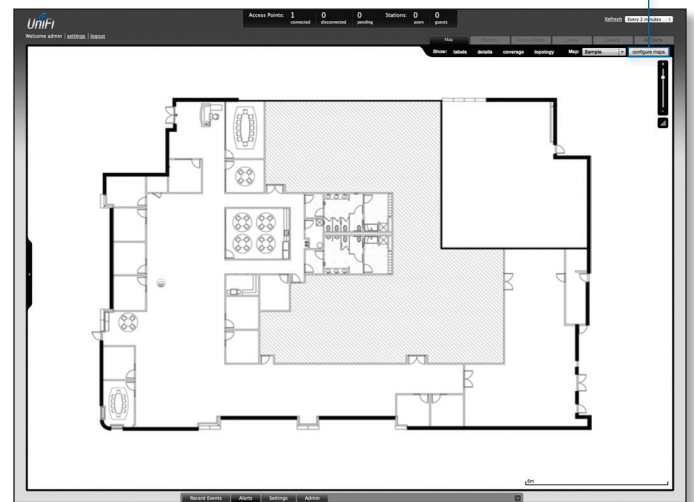

2. Click **Add a Map**.

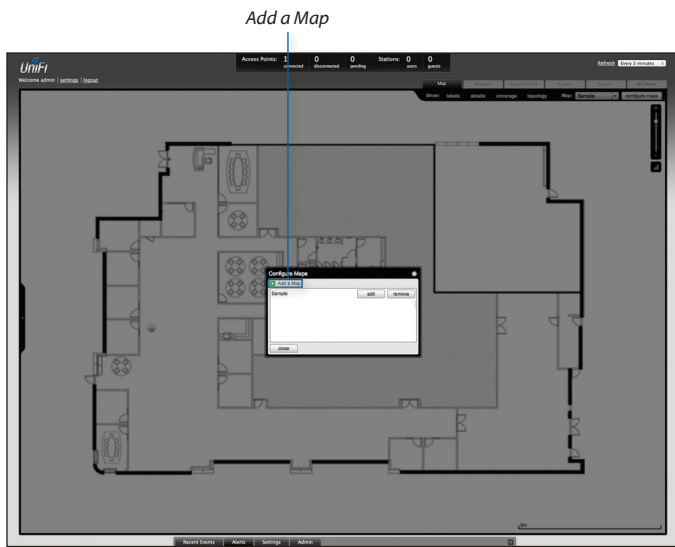

3. Enter a map name in the *Description* field and click **Upload my own**. Click the **Browse** button to locate the file to use as a map (valid file formats are .jpg, .gif, and .png). Click **Continue**.

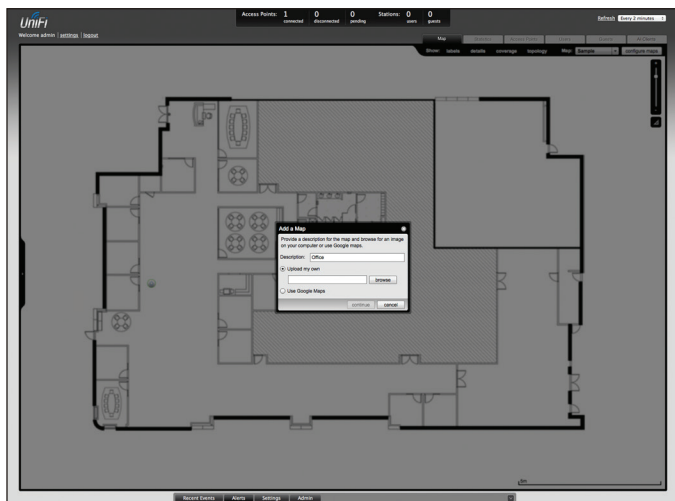

4. Click **Close**.



## Adding a Google Map

To add a *Google Map* to the UniFi Controller software *Map* view:

1. Click **Configure Maps**.

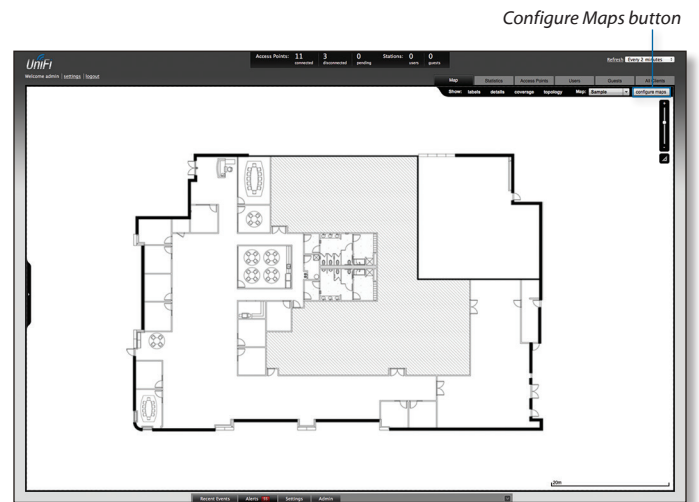

2. Click **Add a Map**.

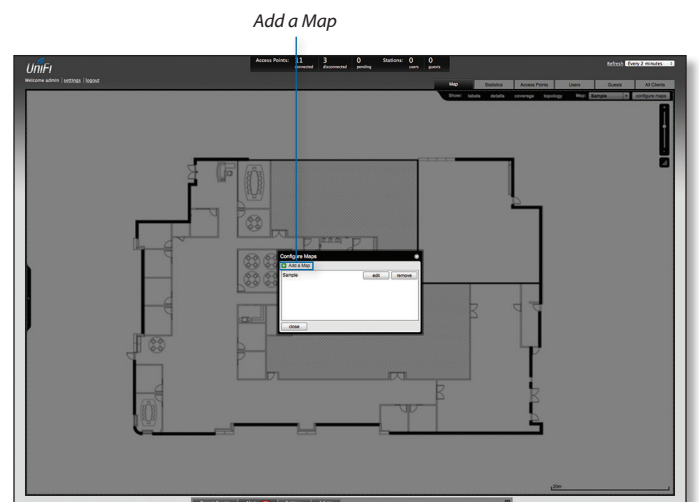

3. Enter a map name in the *Description* field and click **Use Google Maps**. Click **Continue**.

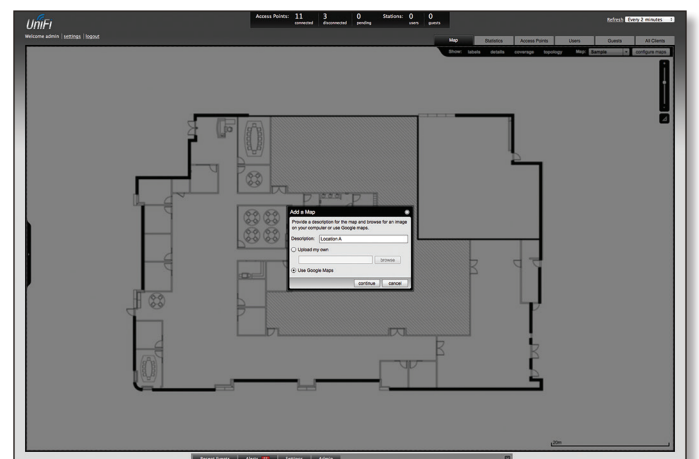



- The default view is *Map*, which looks like a street map. Use the tools on the left to navigate the map or zoom in/out.

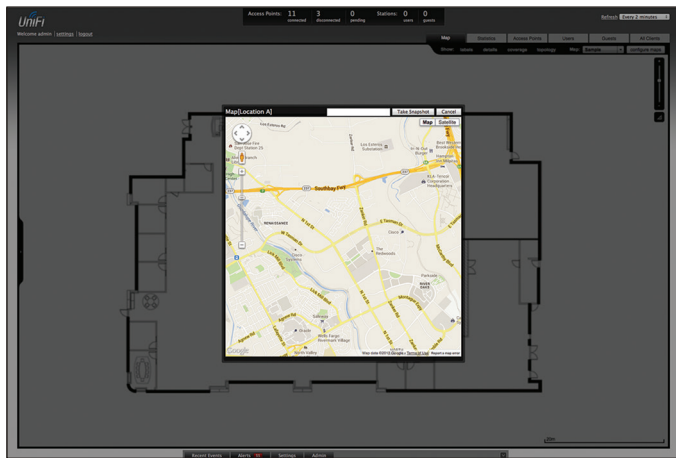

In the *Search* field, you can enter an address or the latitude and longitude of a specific location. Google Maps will automatically update the map.

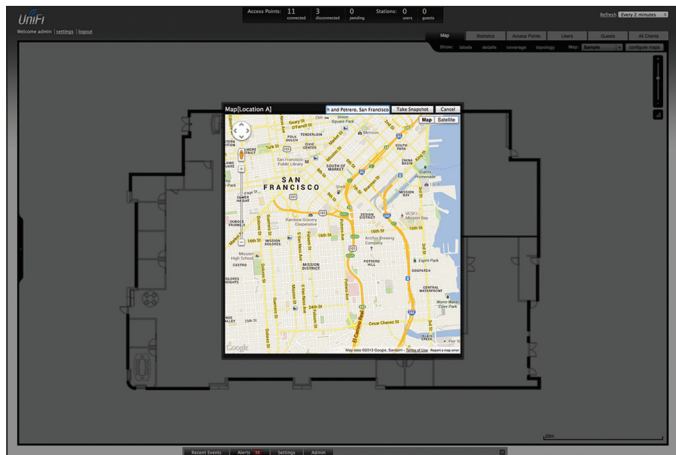

You can also click **Satellite** for a satellite view, as seen from above.

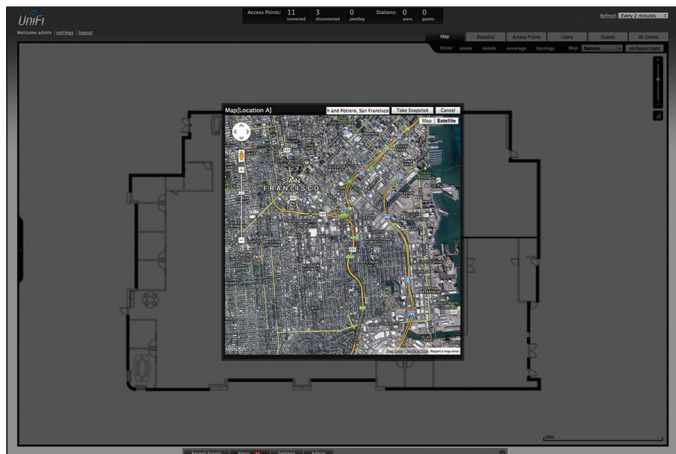

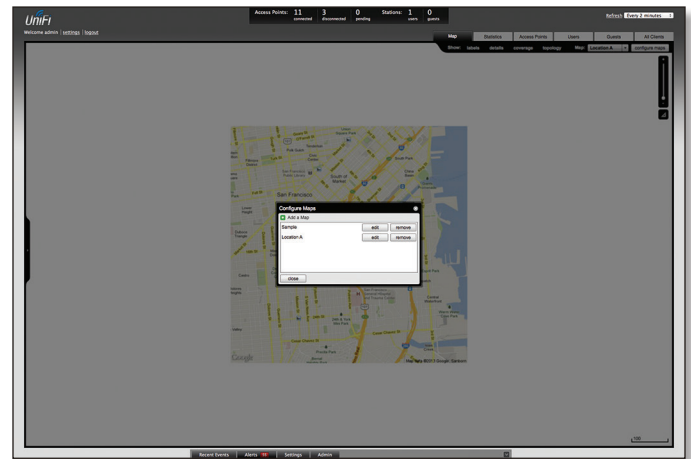

Click **Take Snapshot** to capture a screenshot.

- Click **Close**.



You can adjust the zoom using the slider on the right.

### Placing Access Points on the Map

Drag the *Access Point*  /  icon(s) from the *Unplaced APs* list on the left to the appropriate location(s) on the map.

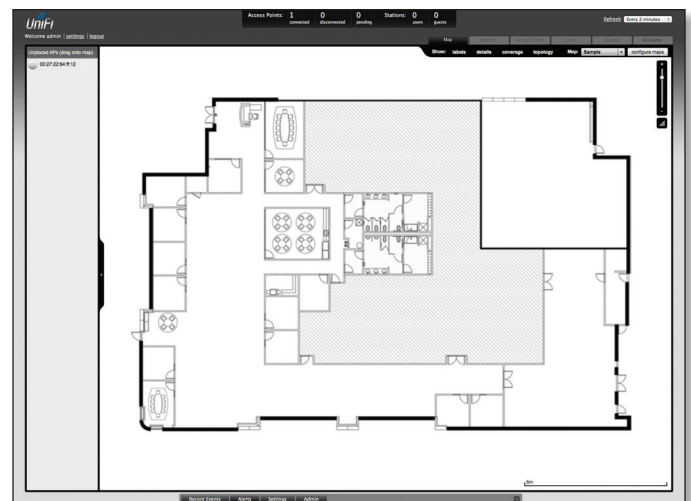

The access point will appear in the area that you placed it.

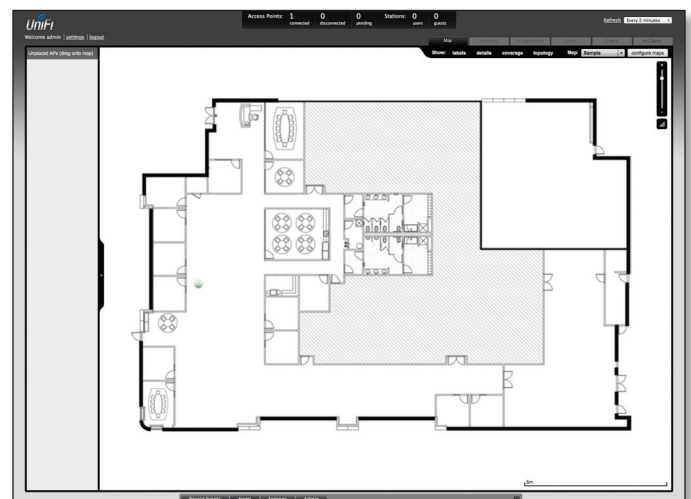



**Wired/Wireless Access Point** Shows the location of the Access Point on the map.



Click and hold this icon to drag the Access Point to another location on the map. Click the *Access Point* icon to reveal additional options. Click a blank area of the map to hide them.



**Lock** Locks the selected Access Point in the current location on the map.



**Details** Brings up the *Details* window. This allows you to view Access Point settings and connected users. You can edit the radio channel, transmit power, uplink, and device alias.

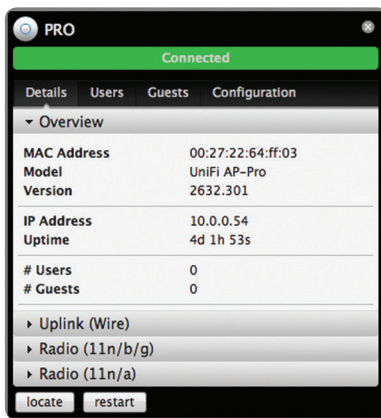

In the *Details* window, there are four tabs: *Details*, *Users*, *Guests*, and *Configuration*.

- **Details** Displays details on the Access Point including the MAC address, model, version, IP address, uptime, connected users, and connected guests. Click **Uplink (Wire)** to display the speed, duplex, Down Pkts / Bytes, Up Pkts / Bytes, and Activity. Click **Radio** to display the channel used, transmit power, and packet information.
- **Users** Displays the hostnames of the users that are connected to the selected Access Point and the IP addresses assigned to them. You can click the hostname to display additional details of each user. A window with *Details*, *Statistics*, and *Configuration* is displayed. The *Details* tab displays the MAC address, hostname, IP address, uptime, and the name of the connected Access Point. The *Statistics* tab displays the channel used, signal strength, transmit and receive rates, power saving enabled or disabled, and the number of packets sent and received. You can also click **History** to see a sortable list of events. The *Configuration* tab allows you to change the alias name for the device.

- **Guests** Displays the MAC address of guests that are connected to the guest network.
- **Configuration** Allows you to change the alias name of the device and channel setting. You can also set the transmit power to *Auto*, *High*, *Medium*, *Low*, or *Custom*. You can also remove the Access Point if you no longer want to manage it with the UniFi Controller software.



**Remove** Remove the Access Point from the location on the map.

**Show:** You can click each of the following options to display Access Point *labels*, *details*, *wireless coverage*, and *topology* on the map.

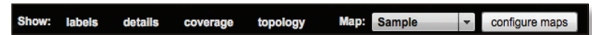

- **Labels** Displays the name applied to the Access Point. Refer to *Alias* under **“Configuration” on page 37** to change a name applied to an Access Point. If no custom label is applied, the Access Point’s MAC address will be displayed.

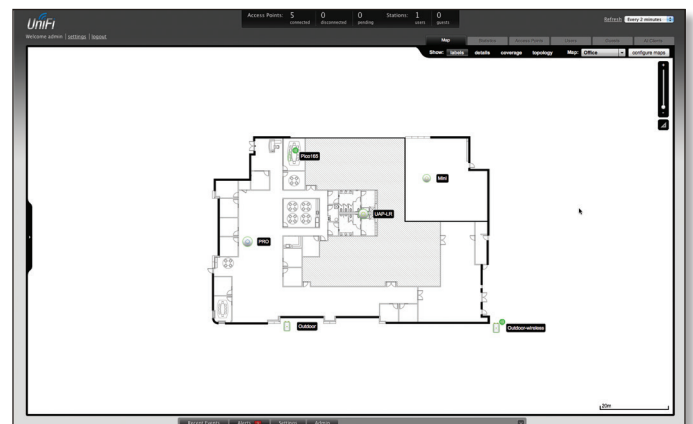

- **Details** Displays the Access Point name, MAC address, transmit/receive channel, number of users connected, and number of guests connected.



- **Coverage** Displays a visual representation of the wireless range covered by the Access Point.



**Topology** Displays a visual representation of the network configuration and connections between Access Points. Any devices that is wirelessly connected will have a wireless icon next to it. A path of arrows will indicate which device the wireless device is downlinking from.

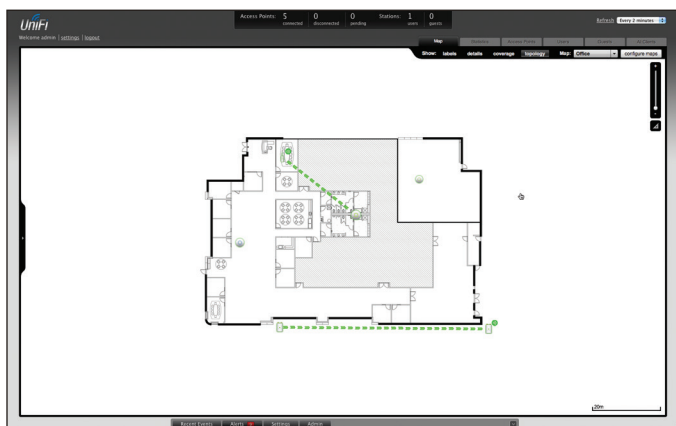

**Map:** If multiple maps have been uploaded, you can select which map you want to view using this option.

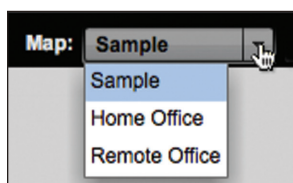

**Configure Maps** Use this option to add maps or edit the current map(s).

**Zoom Slider** Use to zoom the map detail in and out.

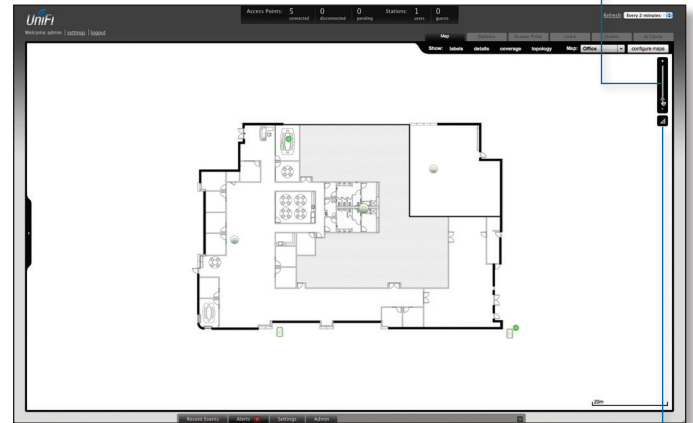

**Set Map Scale** Use this option to define the scale of the map. You will draw a line and define the distance that the line represents.

## Setting the Map Scale

1. Click the **Set Map Scale** button.
2. Click and hold to draw a line in the area that you want to use to set the scale of the map. If you need to redraw the line, just click and hold again to draw a new line. Once you're happy with the line, click **Next**.

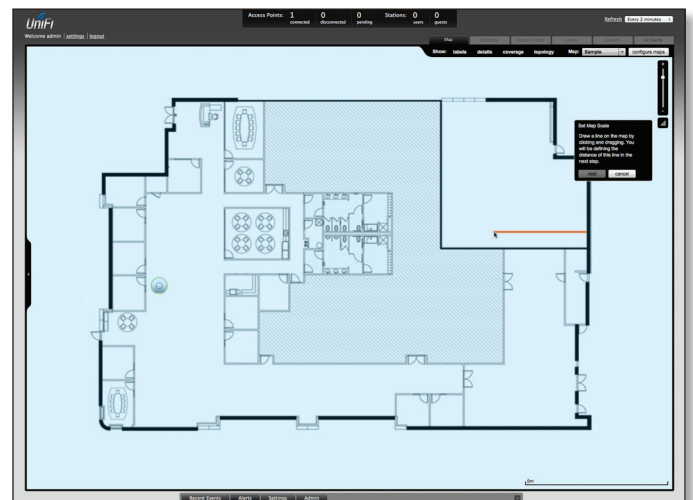

3. Enter the distance that the line represents in the *Distance:* field. The distance is specified in meters by default but you can switch to feet using the drop-down selection menu on the right. Click **Next**.

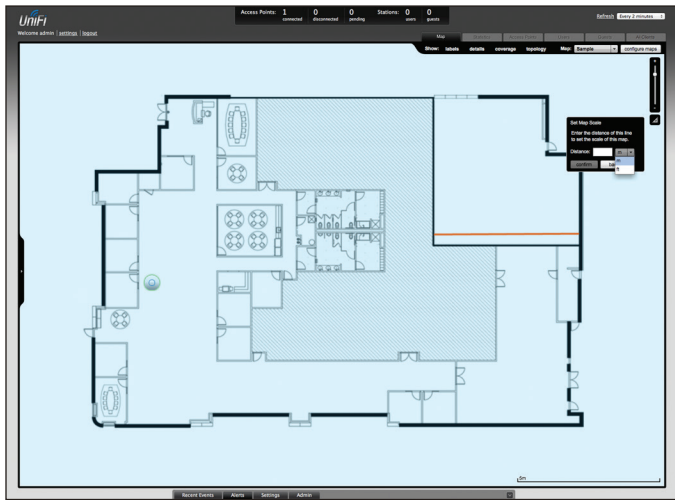



## Chapter 5: Statistics Tab

The *Statistics* tab provides a visual representation of the network traffic connected to your managed APs. Charts representing the number of clients and network traffic are displayed. An hour by hour chart of the usage over the last 24 hours is also displayed on this screen.

## Quick Look

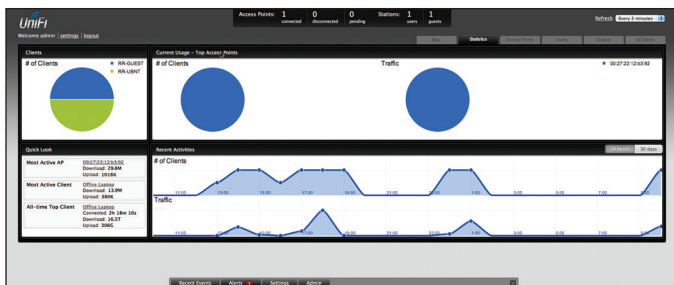
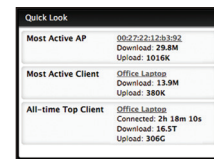

## Clients

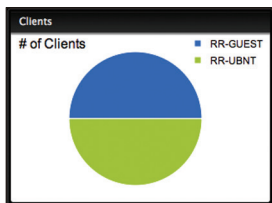

**# of Clients** Displays a visual pie chart representation of the client distribution. Place the mouse cursor over the chart for percentage details.

**Most Active AP** Displays the most active Access Point’s details, including the name or MAC address of the Access Point, the total amount of data uploaded, and the total amount of data downloaded.

The name or MAC address of the Access Point is a clickable link that will open the device details page. See **“Access Point Details” on page 35** for additional information.

**Most Active Client** Displays the details of the most active, currently connected client. The name or MAC address of the client device, the total amount of data uploaded, and the total amount of data downloaded are displayed here.

The name or MAC address of the client device is a clickable link that will open the device details page. See **“User/Guest Details” on page 44** for additional information.

**All-Time Top Client** Displays the details of the all-time most active client. The name or MAC address of the client device, the total amount of data uploaded, and the total amount of data downloaded are displayed here.

The name or MAC address of the client device is a clickable link that will open the device details page. See **“User/Guest Details” on page 44** for additional information.

## Current Usage - Top Access Points

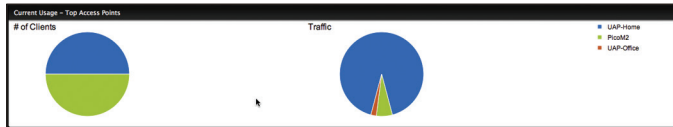

**# of Clients** Displays a visual pie chart representation of the client distribution on the most active Access Points. Place the mouse cursor over the chart for percentage details.

**Traffic** Displays a visual pie chart representation of traffic on the most active Access Points. Place the mouse cursor over the chart for percentage details.

## Recent Activities



The Recent Activities statistics can be toggled between a view for the last 24 hours and a view for the last 30 days.

**# of Clients** Displays a visual graph of the number of clients connected during the selected time period (last 24 hours or last 30 days).

**Traffic** Displays a visual graph of the network traffic during the selected time period (last 24 hours or last 30 days).

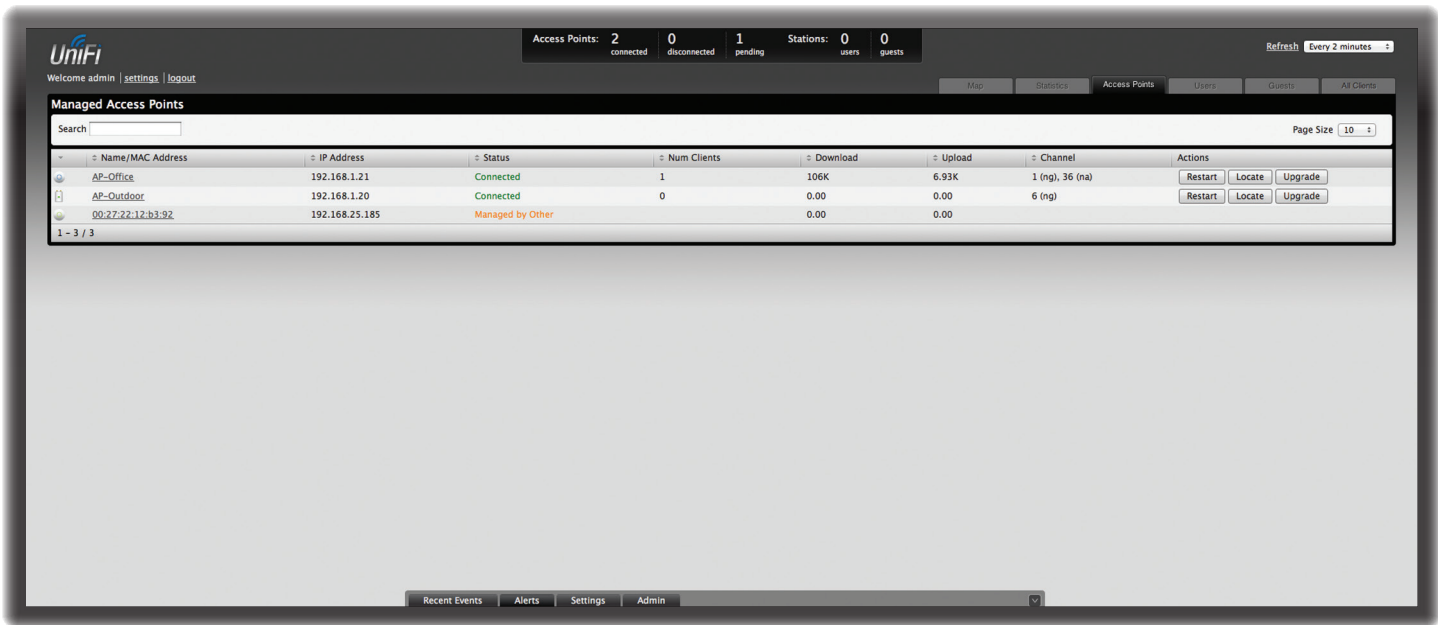

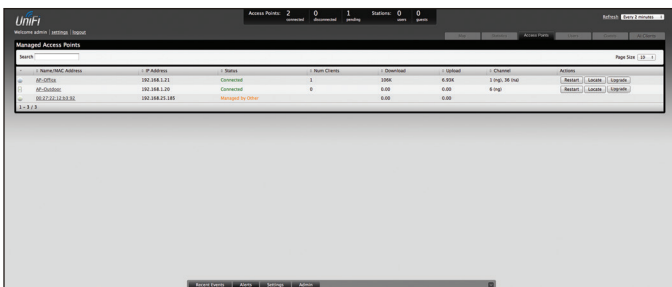

## Chapter 6: Access Points Tab

The *Access Points* tab displays a list of managed Access Points, each displaying its icon, name, IP address, status, number of clients connected, download/upload statistics, and transmit/receive channel. You can click any of these column headers to change the list order.



**Search** Allows you to enter text you want to search for. Simply begin typing; there is no need to press **Enter**.

**Page Size** Allows you to determine how many results are displayed per page. Select **10**, **20**, **30**, **40**, **60**, or **100**.

**Icon** Displays the icon  /  of the Access Point (icon will vary depending on model).

**Name/MAC Address** Displays the hostname, alias, or MAC address of the Access Point. You can click the name to get additional details on the Access Point.

**IP Address** Displays the IP address of the Access Point.

**Status** Displays the connection status information.

- **Connected** Displays that the Access Point connection is physically wired.
- **Connected (wireless)** Displays that the Access Point connection is wirelessly downlinked to a physically wired Access Point.

- **Disconnected** Displays if the Access Point is unreachable by the UniFi Controller software. Disconnected Access Points will also appear under *Access Points > Disconnected* at the top of the interface.
- **Isolated** A managed Access Point that is unable to locate its uplink.
- **Managed by Other** Displays if the Access Point is not in the default state but it is not controlled by the UniFi Controller.
- **Pending Approval** Displays if the Access Point is in the default state and is available for adoption.

**Num Clients** Displays the number of clients connected to the Access Point.

**Download** Displays the total size of downloads via the Access Point.

**Upload** Displays the total size of uploads via the Access Point.

**Channel** Displays the transmit/receive channel being used by the Access Point. The radio band is represented as *(ng)* for 2.4 GHz and *(na)* for 5 GHz.

**Actions** Select an action button to perform the desired action:

- **Restart** Restart the selected Access Point.
- **Locate** Click to locate the Access Point on the map. The button will flash green and black until the *Locate* button is clicked again. The LED on the Access Point will flash so that you can place it in the correct location on the map. The LED will flash until the *Locate* button is clicked again.

- **Adopt** Click to adopt an Access Point that appears under *Access Points > Pending* at the top of the interface. The *Status* will appear as *Adopting* until the Access Point is connected.



Managed Access Points								
Search								
	Name/MAC Address	IP Address	Status	Num Clients	Download	Upload	Channel	Actions
	00:27:22:40:4c:8e	192.168.25.3	Adopting		0.00	0.00		

- **Upgrade** If a software upgrade is available for the Access Point, click **Upgrade** to install the latest UniFi firmware on the device. The *Status* will appear as *Upgrading* until the process is complete and the Access Points reconnects to the UniFi Controller software.

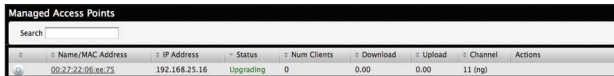

Managed Access Points								
Search								
	Name/MAC Address	IP Address	Status	Num Clients	Download	Upload	Channel	Actions
	00:27:22:06:ea:75	192.168.25.16	Upgrading	0	0.00	0.00	11 (ng)	



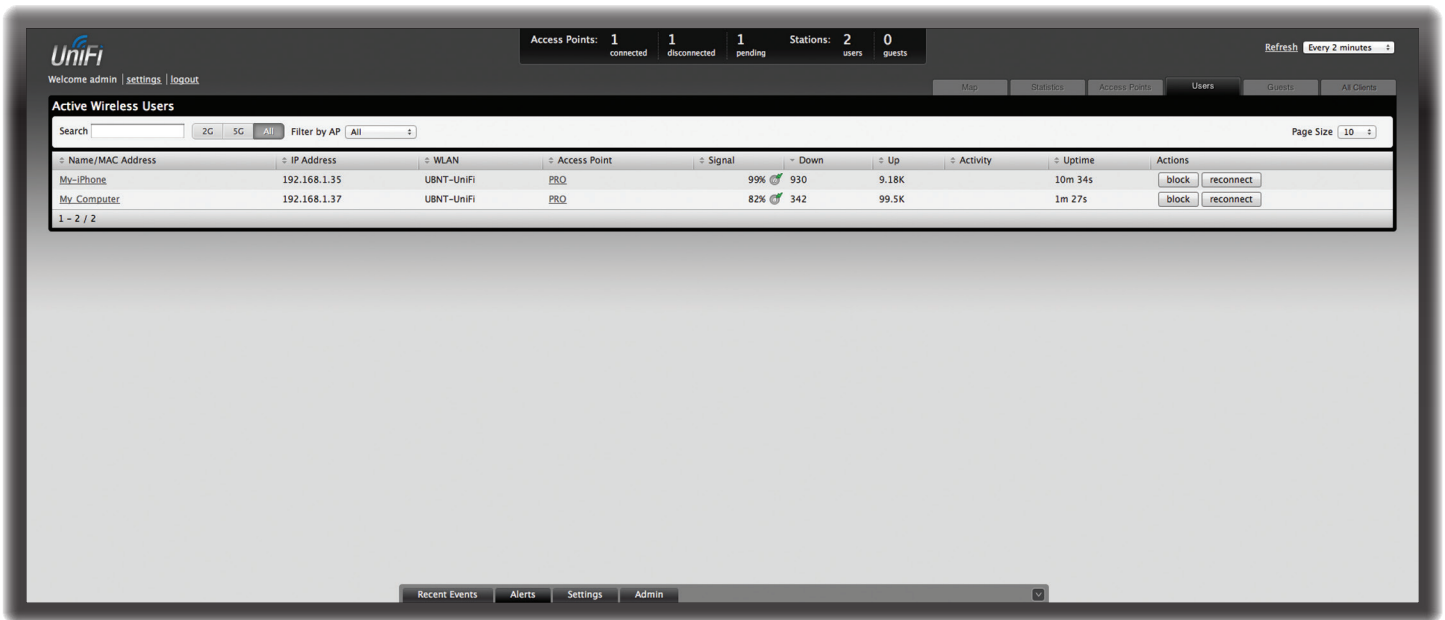

## Chapter 7: Users Tab

The *Users* tab displays a list of users that are connected to the primary wireless network of the Access Point.

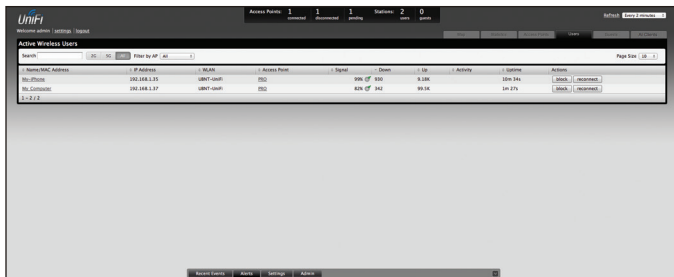

**Search** Allows you to enter text you want to search for. Simply begin typing; there is no need to press **Enter**.

- **2G** Select if you only want users of the 2.4 GHz wireless network displayed.
- **5G** Select if you only want users of the 5 GHz wireless network displayed.
- **All** Select to show all users.

**Filter by AP** Drop-down list of all available Access Points. Select one to filter the results and display only users connected to the selected Access Point.

**Page Size** Allows you to determine how many results are displayed per page. Select **10, 20, 30, 40, 60,** or **100**.

**Name/MAC Address** Displays the hostname, alias, or MAC address of the connected user. You can click the name to get additional details.

**IP Address** Displays the IP address assigned to the user.

**WLAN** Displays the name of the SSID (network name) of the wireless LAN (WLAN) that the user is connected to.

**Access Point** Displays the hostname or alias of the Access Point. You can click the name to get additional details on the Access Point.

**Signal** Displays the signal strength and type from the Access Point to the client. If a lightning bolt symbol is present, the device is in power save mode. The device will return to active mode when *Down* or *Up* activity resumes.

Icon	Clients	Mode
	5 GHz (802.11a, 802.11n/a, or 802.11ac)	Active
	5 GHz (802.11a, 802.11n/a, or 802.11ac)	Power Save
	2.4 GHz (802.11n)	Active
	2.4 GHz (802.11n)	Power Save
	2.4 GHz (802.11g)	Active
	2.4 GHz (802.11g)	Power Save
	2.4 GHz (802.11b)	Active
	2.4 GHz (802.11b)	Power Save

**Down** Displays the total bytes of data received by the user.

**Up** Displays the total bytes of data sent by the user.

**Activity** Displays the level of activity for each user.

Bars	Activity Level (Bytes per second)
	Idle
■	500
■ ■	8000
■ ■ ■	64000
■ ■ ■ ■	512000
■ ■ ■ ■ ■	2048000

**Uptime** Displays the total time the user has been connected for this session.

**Actions** Click an action button to perform the appropriate action.

- **Block** Click this button to block a specific user from accessing the Access Point. This will add the client to the Blocked Device list.
- **Reconnect** Click this button to reconnect a specific user to the Access Point.

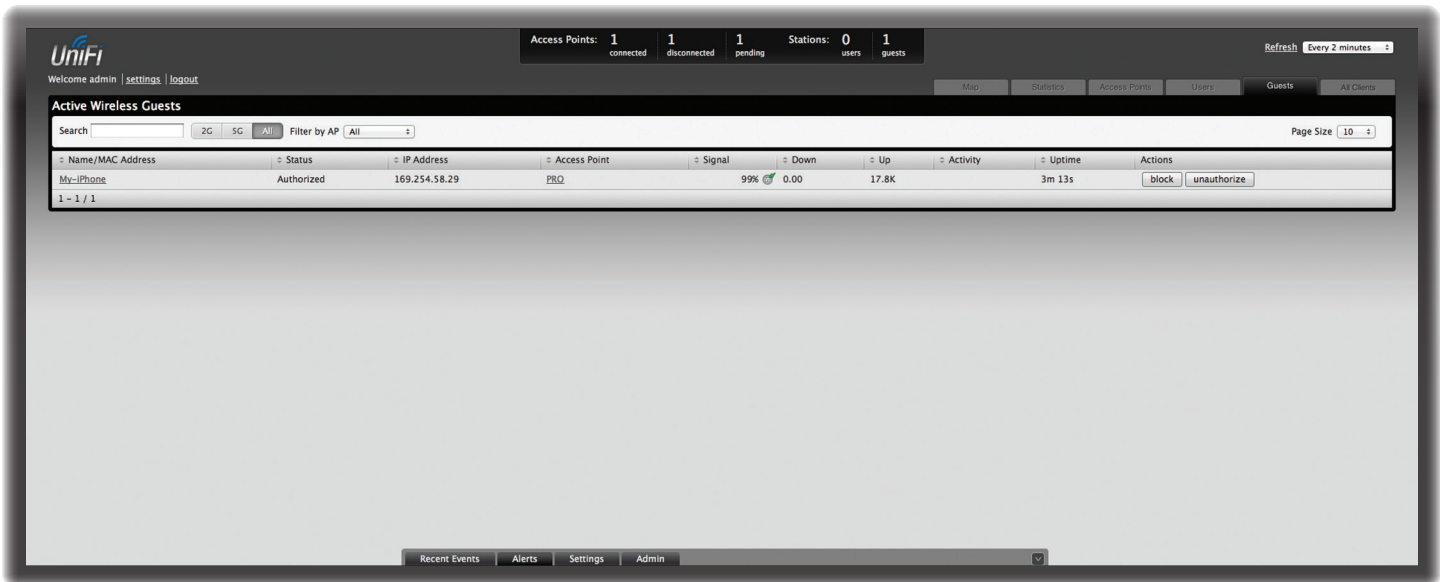

## Chapter 8: Guests Tab

The *Guests* tab displays a list of users that have connected to the guest network of the Access Point.

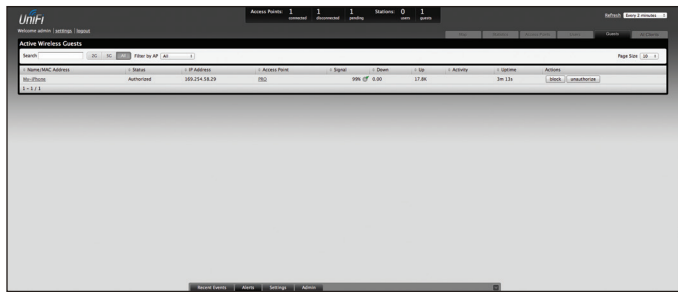

**Search** Allows you to enter text you want to search for. Simply begin typing; there is no need to press **Enter**.

- **2G** Select if you only want guests of the 2.4 GHz wireless network displayed.
- **5G** Select if you only want guests of the 5 GHz wireless network displayed.
- **All** Select to show all guests.

**Filter by AP** Drop-down list of all available Access Points. Select one to filter the results and display only guests connected to the selected Access Point.

**Page Size** Allows you to determine how many results are displayed per page. Select **10**, **20**, **30**, **40**, **60**, or **100**.

**Name/MAC Address** Displays the hostname, alias, or MAC address of the connected guest. You can click the name to get additional details.

**Status** Indicates whether the guest is authorized or not. For authorization, guests must accept the Terms of Use if the guest portal is enabled and authenticate if authentication is enabled.

**IP Address** Displays the IP address assigned to the guest.

**Access Point** Displays the hostname or alias of the Access Point. You can click the name to get additional details on the Access Point.

**Signal** Displays the signal strength and type from the Access Point to the client. If a lightning bolt symbol is present, the device is in power save mode. The device will return to active mode when *Down* or *Up* activity resumes.

Icon	Clients	Mode
	5 GHz (802.11a, 802.11n/a, or 802.11ac)	Active
	5 GHz (802.11a, 802.11n/a, or 802.11ac)	Power Save
	2.4 GHz (802.11n)	Active
	2.4 GHz (802.11n)	Power Save
	2.4 GHz (802.11g)	Active
	2.4 GHz (802.11g)	Power Save
	2.4 GHz (802.11b)	Active
	2.4 GHz (802.11b)	Power Save

**Down** Displays the total bytes of data received by the guest.

**Up** Displays the total bytes of data sent by the guest.

**Activity** Displays the level of activity for each guest.

Bars	Activity Level (Bytes per second)
	Idle
■	500
■ ■	8000
■ ■ ■	64000
■ ■ ■ ■	512000
■ ■ ■ ■ ■	2048000

**Uptime** Displays the total time the guest has been connected for this session.

**Actions** Click an action button to perform the appropriate action.

- **Block** Click this button to block a specific guest from accessing the Access Point.
- **Reconnect** Click this button to reconnect a specific guest to the Access Point.
- **Authorize** When a guest is in a pending state, authorization can be granted here manually.
- **Unauthorize** Removes authorization of wireless guest access and disconnects the client.

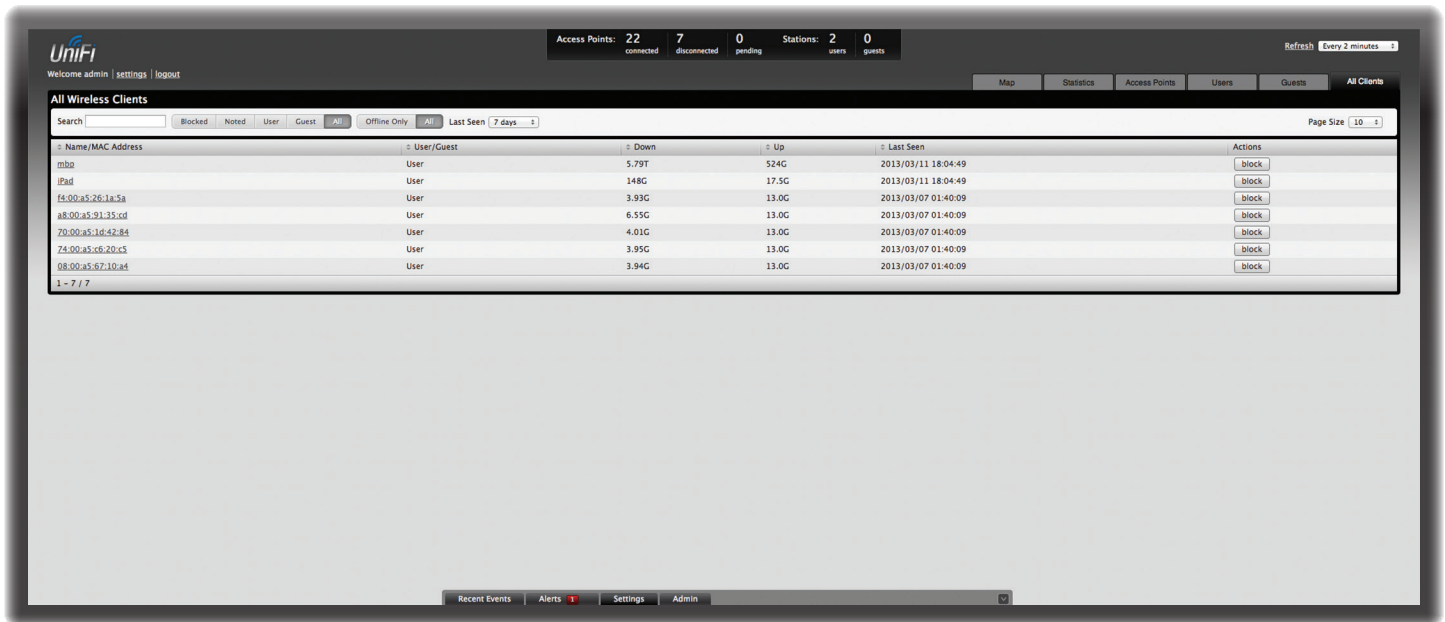

## Chapter 9: All Clients Tab

The *All Clients* tab displays a list of clients that have connected to the guest or primary network of the Access Point at some time during the period specified.

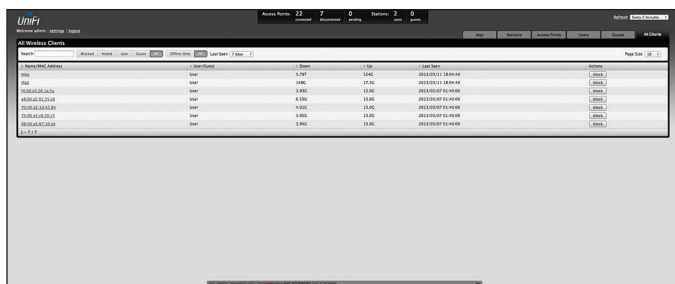

**Search** Allows you to enter text you want to search for. Simply begin typing; there is no need to press **Enter**.

You can apply the following primary filters:

- **Blocked** Select if you only want blocked users and guests displayed.
- **Noted** Select if you only want users and guests whose configurations include notes or who are forced to connect to a specific Access Point. (See [“Configuration” on page 45](#) for more information.)
- **User** Select if you only want users displayed.
- **Guest** Select if you only want guests displayed.
- **All** Select to show all users and guests.

For the User, Guest, and All filters, a secondary filter is available:

- **Offline Only** Select if you only want clients who connected to the guest or primary network of the Access Point at some time during the period specified.
- **All** Select to show all users and guests.

**Last Seen** Drop-down list that allows you to filter the results on the page based on the time the user was last seen. Select **1 day**, **3 days**, **7 days**, **2 weeks**, **1 month**, **2 months**, or **1 year**.

**Page Size** Allows you to determine how many results are displayed per page. Select **10**, **20**, **30**, **40**, **60**, or **100**.

**Name/MAC Address** Displays the hostname, alias, or MAC address of the connected user. You can click the name to get additional details.

**User/Guest** Indicates whether the user is connected to the primary or guest network.

**Down** Displays the total bytes of data received by the user.

**Up** Displays the total bytes of data sent by the user.

**Last Seen** Displays the last date and time the wireless client was connected to the primary or guest network.

**Actions** Click an action button to perform the appropriate action.

- **Block** Click this button to block a specific user from accessing the Access Point. After you have blocked a user, click **unblock** to allow access.

# Chapter 10: Access Point Details

UniFi Access Points connect to the UniFi Controller software either by Ethernet, denoted as *Connected*, or by a wireless connection, denoted as *Connected (wireless)*. Based on connection type, options under each tab vary.

 **Note:** The UniFi AP-PRO or AP-AC does not support wireless uplinks for the initial release, but it will with a future firmware upgrade.

The upper part of the window has four clickable tabs. The bottom of the window has *Locate* and *Restart* buttons. Use the **Locate** button to flash the LED on the Access Point and flash the Access Point icon on the map. Use the **Restart** button to restart the Access Point. The four tabs include *Details*, *Users*, *Guests*, and *Configuration*.

 **Note:** The UniFi AP-PRO is described in this chapter; however, the same information applies to the UniFi AP-AC with the addition of 11ac (802.11ac) for the *Radio* sections.

## Details

Displays details about the Access Point. Click **Overview** to display the device specifics, connection details, uptime, and user statistics.

## Overview

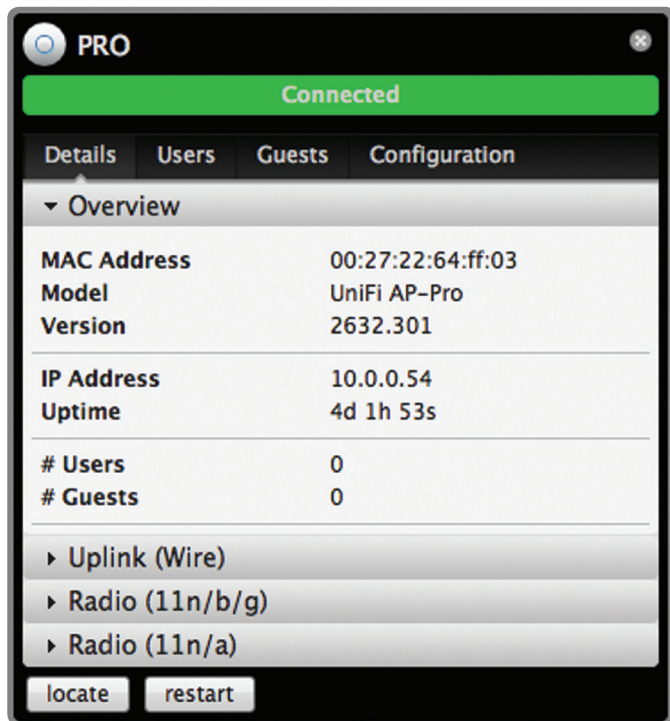

**MAC address** Displays the MAC address of the Access Point.

**Model** Displays the model information.

**Version** Displays the version of software used on the Access Point.

**IP address** Displays the IP address of the Access Point.

**Uptime** Displays the amount of time the Access Point has been running without interruption.

**# Users** Displays the number of users connected to the primary network.

**# Guests** Displays the number of users connected to the guest network.

## Uplink (Wire)

Displays details on a wired Access Point including the connection speed, duplex type, Down Pkts / Bytes in K/M, Up Pkts / Bytes in K/M, and Activity in B/sec.

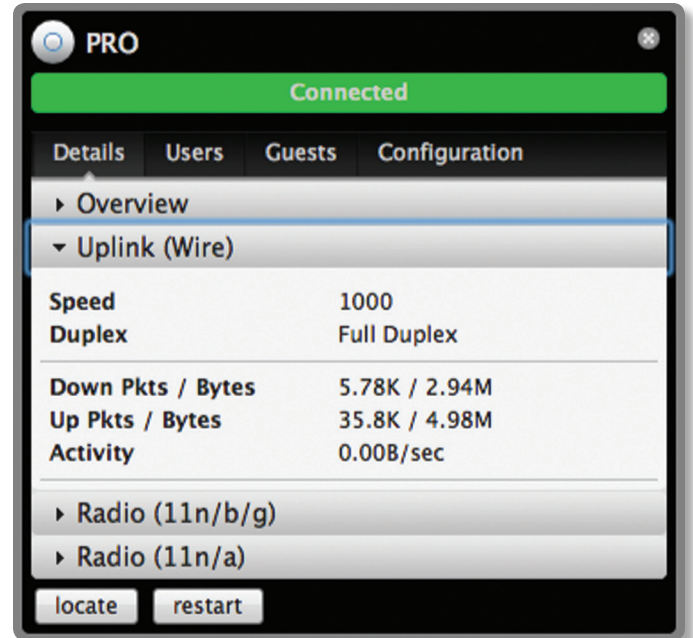

### Radio (11n/b/g) or Radio (11n/a)

Click **Radio (11n/b/g)** or **Radio (11n/a)** to display the channel and transmit/receive statistics.

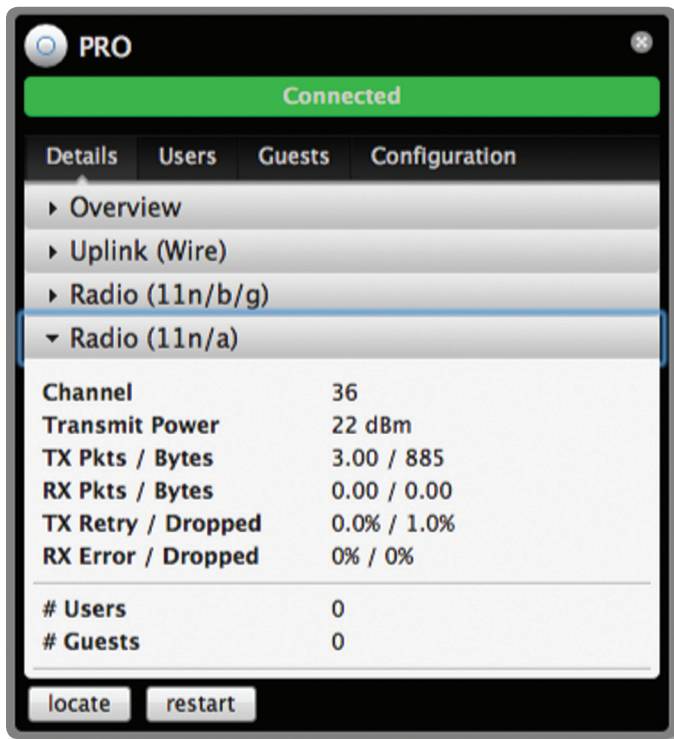
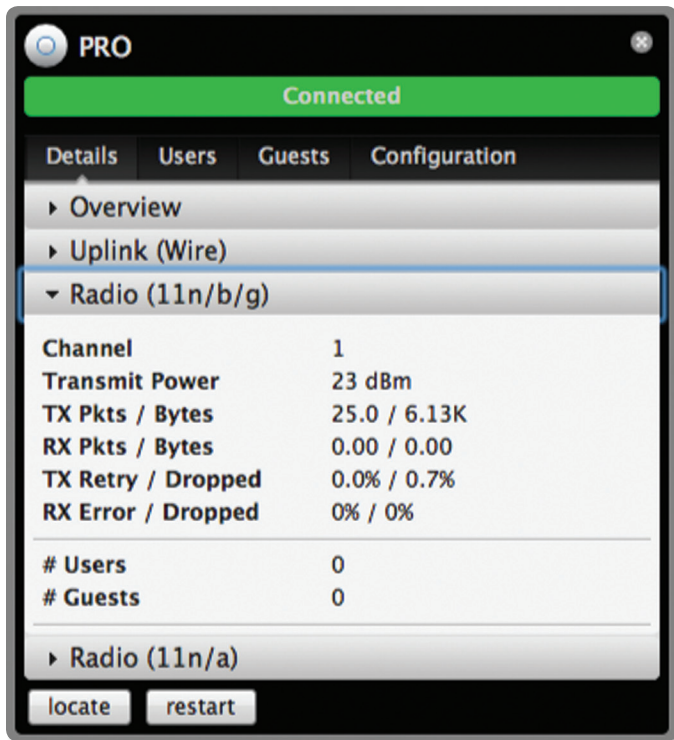

**Channel** Displays the wireless channel being used.

**Transmit Power** Displays the EIRP in dBm.

 **Note:** If the device has an external antenna, you can place the mouse over the icon for additional details.

**TX Pkts / Bytes** Displays the number of packets and total bytes transmitted by the Access Point.

**RX Pkts / Bytes** Displays the number of packets and total bytes received by the Access Point.

**TX Retry / Dropped** Displays the percentage of transmitted packets that needed to be resent and the percentage of packets that were dropped.

**RX Error / Dropped** Displays the percentage of packets received that needed to be resent and the percentage of packets that were dropped.

**# Users** Displays the number of users connected to the primary network.

**# Guests** Displays the number of users connected to the guest network.

### Users

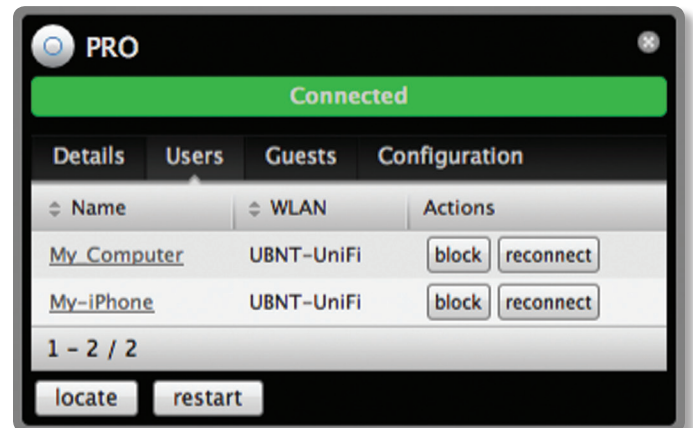

**Name** Displays the name (MAC address if not defined) of users connected to the primary network of the selected Access Point. You can click the links under *Name* to display additional details of each user (see [“User/Guest Details” on page 44](#) for more information).

**WLAN** Displays the name of the SSID (network name) of the wireless LAN (WLAN) that the user is connected to.

**Actions** Select from one of the following actions:

- **Block** Click this button to block a specific user from accessing the Access Point. This will add the client to the Blocked Device list.
- **Reconnect** Click this button to reconnect a specific user to the Access Point.

## Guests

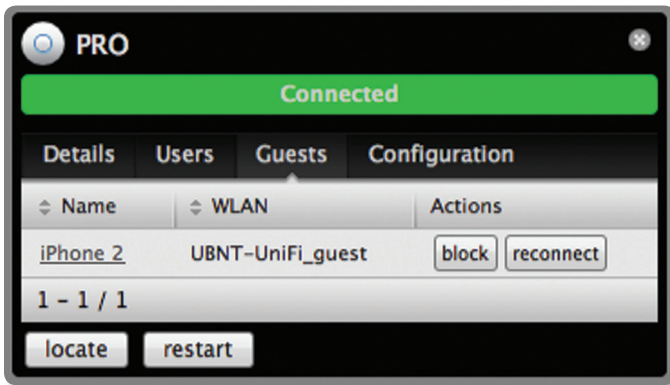

**Name** Displays the name (MAC address if not defined) of users connected to the guest network of the selected Access Point. You can click the links under *Name* to display additional details of each user (see [“User/Guest Details” on page 44](#) for more information).

**WLAN** Displays the name of the SSID (network name) of the wireless LAN (WLAN) that the user is connected to.

**Actions** Select from one of the following actions:

- **Block** Click this button to block a specific user from accessing the Access Point. This will add the client to the Blocked Device list.
- **Reconnect** Click this button to reconnect a specific user to the Access Point.

## Configuration

Allows you to change device configuration settings. Click the **apply** button to commit any changes.

### Config

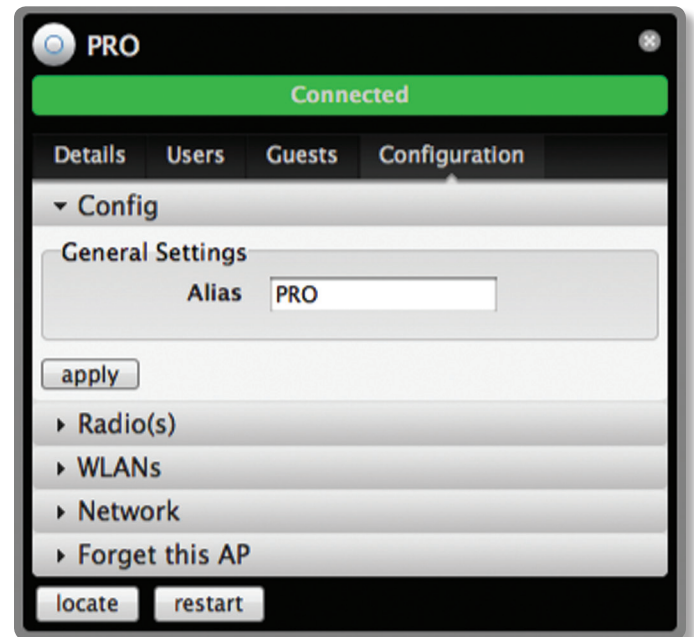

### General Settings

**Alias** Allows you to name the device. Click **Apply** to save your change.



## Radio(s)

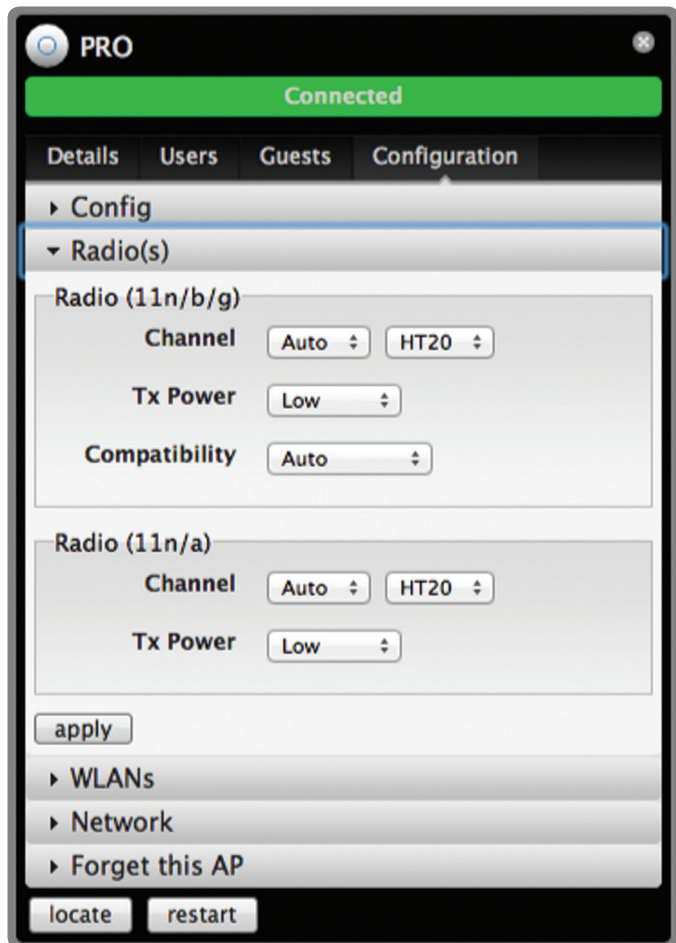

### Radio (11n/b/g) or Radio (11n/a)

**Channel** Select a channel or leave the default auto setting. You can also use the default *HT20* for 20 MHz operation or *HT40* for 40 MHz operation.

**Tx Power** By default the transmit power is set to *Auto*. You can also manually select *High*, *Medium*, *Low* or *Custom*.

- **High** The highest TX power we can deliver.
- **Low** The lowest TX power.
- **Medium** Halfway in between High and Low.
- **Custom** Full custom setting.

If the AP is using an external antenna, the *Antenna Gain* field will appear, allowing you to specify the gain of the attached antenna. After applying the settings, go to **Transmit Power** under *Details > Radio (11n/g/b)*, which always shows EIRP, and place the mouse over it to display how it's calculated.

**Compatibility** (Available for *11n/b/g* only.) Selects the wireless compatibility mode. By default this is set to auto. Choose one of the following:

- **Auto** Supports wireless b/g/n standards.
- **11n/11g only** Only supports wireless-n and wireless-g devices.
- **11n only** Only supports wireless-n devices.
- **11g only** Only supports wireless-g devices.

Click **apply** to save any changes that you have made.

## WLANs

Allows the deployment of different WLANs on different Access Points.

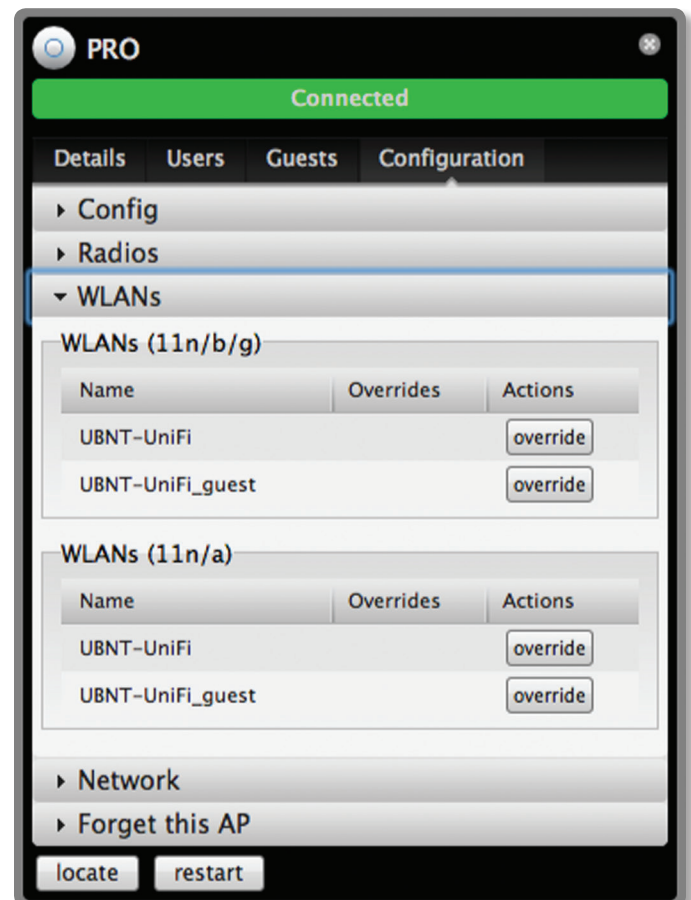

### WLANs (11n/b/g) or WLANs (11n/a)

**Name** Displays the name of the SSID (network name) of the wireless LAN (WLAN) that is available for the user to connect to.

**Overrides** Displays SSID override information applied to the wireless LAN (WLAN) using the *Actions > Override* option.

**Actions** Click **Override** to enable a VLAN, set the VLAN ID, and enter the SSID override name to apply to the wireless LAN (WLAN).

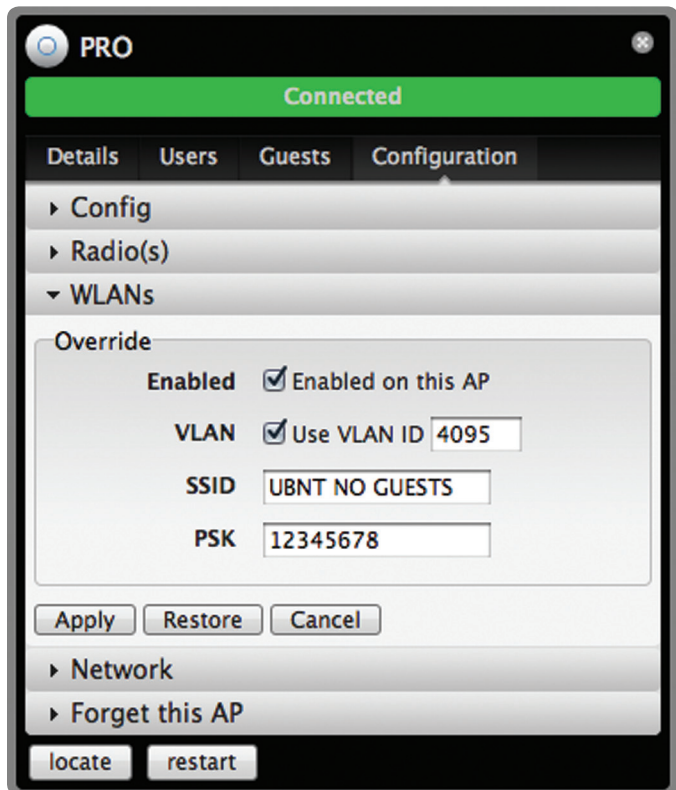

**Enabled** Select to enable or clear to disable override settings on the WLAN.

**VLAN** Select to enable VLAN or clear to disable VLAN.

**VLAN ID** The VLAN ID is a unique value assigned to each VLAN at a single device; every VLAN ID represents a different Virtual Local Area Network. A value between 2 and 4095 may be entered. For example, in a larger deployment where there are multiple buildings, it's possible that a different VLAN ID is used in each building while still on the same corporate network.

**SSID** Enter the SSID override name to apply to the wireless LAN (WLAN).

**PSK** If the WPA-Personal security option has been applied to the WLAN under *Settings > Wireless Networks*, the Pre-Shared Key (PSK) for the SSID specified will automatically appear in this field.

Click **Apply** to save any changes that you have made. Click **Restore** to remove any overrides that were applied to the selected WLAN. Click **Cancel** to prevent application of any changes you have made.

## Network

The Access Point can be configured to obtain an IP address automatically or configured with a static IP address.

### Network Settings

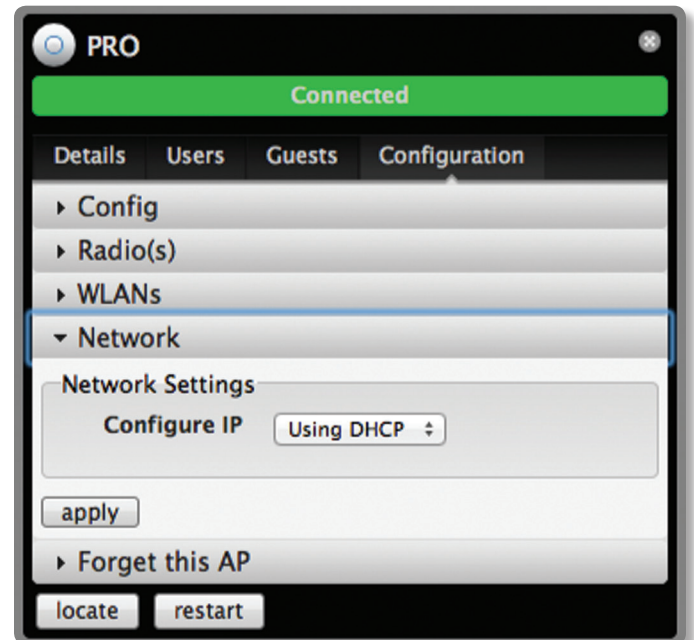

**Configure IP** Select between *Using DHCP* or *Static IP*:

- **Using DHCP** Choose this option to obtain the IP address, Gateway, and DNS address dynamically from the external DHCP server.

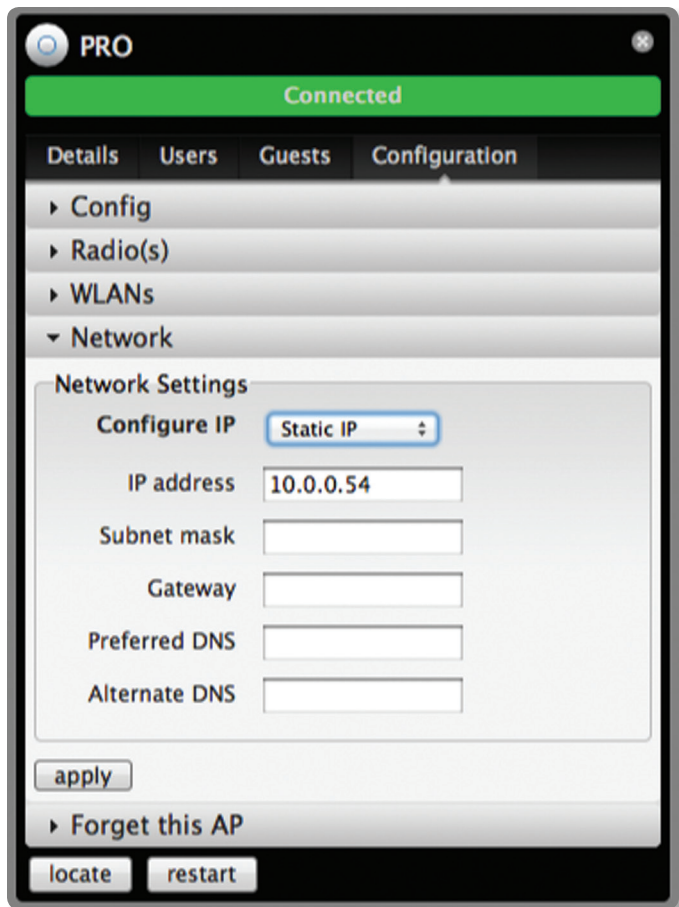

## Access Point - Heartbeat Missed

When a wired Access Point is disconnected from the router, its state will initially change to *Heartbeat Missed*, followed by *Isolated*.

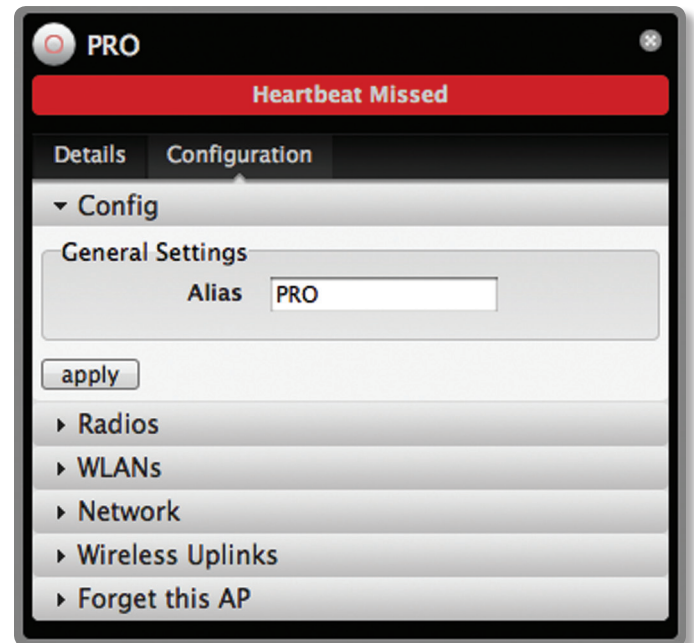

- **Static IP** Choose this option to assign the static IP address, Subnet mask, Gateway, Preferred DNS, and Alternate DNS for the Access Point.
  - **IP address** Enter the IP address for the Access Point.
  - **Subnet mask** Enter the subnet mask for the Access Point.
  - **Gateway** Enter the gateway address.
  - **Preferred DNS** Enter a primary DNS address.
  - **Alternate DNS** Enter a secondary DNS address.

Click **apply** to save any changes that you have made.

## Access Point - Isolated

When an Access Point is in an *Isolated* state, you can reestablish a connection to the UniFi Controller software using one of two methods:

- Reconnect the Access Point to the router.
- Connect an Ethernet cable from the *Secondary Ethernet Port* of the isolated Access Point to the *Secondary Ethernet Port* of another UniFi AP that is connected to the router.



**Isolated Access Point** In an *Isolated* state, the Access Point icon will change to red/orange on the *Map* tab.



The LED on the actual device will be steady green with occasional flashing. This Access Point doesn't provide any wireless service.



**Note:** Do not use the *Forget this AP* option when the Access Point is in an *Isolated* state. If you do, then the only way to make the Access Point accessible from the UniFi Controller is to take it down and connect it by wire.

## Access Point - Managed by Other

When an Access Point is in *Managed by Other* state, this indicates that the Access Point is not in the default state but it is not controlled by the UniFi Controller.

### Overview

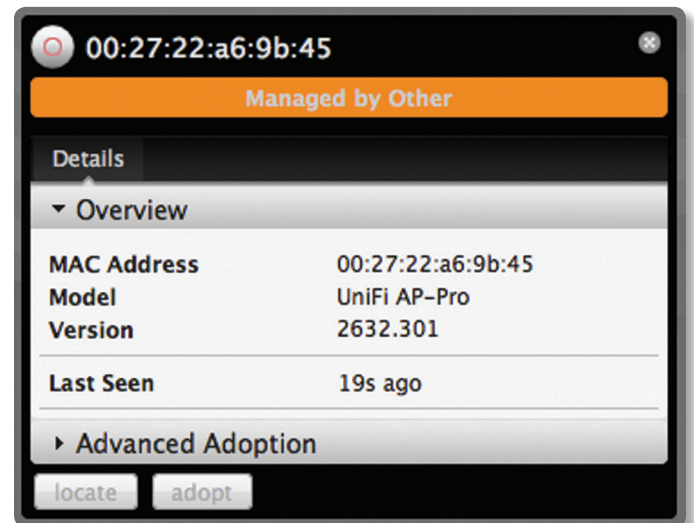

**MAC address** Displays the MAC address of the Access Point.

**Model** Displays the model information.

**Version** Displays the version of software used on the Access Point.

**Last Seen** Displays the amount of time that has passed since the Access Point was last seen.

## Advanced Adoption

00:27:22:a6:9b:45

Managed by Other

Details

Overview

Advanced Adoption

IP  
192.168.20.115 : 22

Username  
[Empty field]

Password  
[Empty field]

Inform URL  
http://192.168.20.110:808

adopt

locate adopt

**IP** The IP address and SSH port of the Access Point are populated here.

**Username** Enter the SSH Username for management access.

**Password** Enter the SSH Password for management access.

**Inform URL** The URL will be populated but you may need to verify the accuracy as the system may have multiple interfaces.

**Adopt** Click to adopt the Access Point so you can manage it using the UniFi Controller software.

## Access Point - Pending Approval

When an Access Point is in *Pending Approval* state, this indicates that the Access Point is in the default state and is available for adoption.

00:27:22:a6:9b:45

Pending Approval

Details

Overview

MAC Address	00:27:22:a6:9b:45
Model	UniFi AP-Pro
Version	2632.301
Last Seen	1m 39s ago

locate adopt

**MAC address** Displays the MAC address of the Access Point.

**Model** Displays the model information.

**Version** Displays the version of software used on the Access Point.

**Last Seen** Displays the amount of time that has passed since the Access Point was last seen.

**Locate** Click to flash the LED on the Access Point and flash the Access Point icon on the map.

**Adopt** Click to adopt the Access Point so you can manage it using the UniFi Controller software.

## Forget this AP

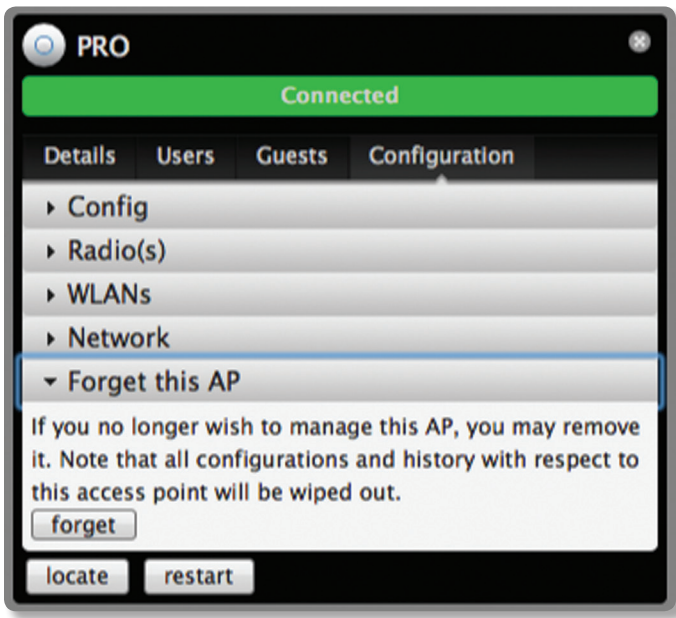

**Forget** Click to remove the Access Point from management by the UniFi Controller software and to restore it to factory default settings.

 **Note:** Use caution when clicking *forget*. This will restore the Access Point to factory settings when in a *Connected* state. Do not use the *Forget* option when the Access Point is in an *Isolated* state. If you do, the only way to make the Access Point accessible from the UniFi Controller is to take it down and connect by wire.

## Chapter 11: User/Guest Details

The User and Guest hyperlinks bring up the *User/Guest Details* window. Unless otherwise needed to specify differences between the user and guest, this User Guide will refer to both as user in the rest of this chapter.

There are four clickable tabs at the top of the window and two buttons located on the bottom of the window. The buttons are accessible from any of the tabs and perform the following actions:

**Block** Allows you to block the selected user from accessing the network.

**Reconnect** Allows you to reconnect a user that has been blocked previously.

**Unauthorize** (Available for *guests* only.) Allows you to remove authorization of wireless guest access and disconnect the client.

The four tabs contain the following information:

### Details

#### Overview

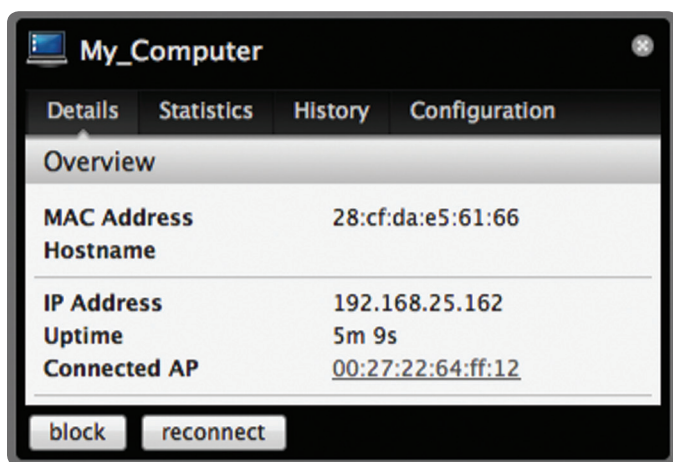

**MAC Address** Displays the MAC address of the user.

**Hostname** Displays the name (if defined).

**IP Address** Displays the IP address of the Access Point.

**Uptime** Displays the amount of time the Access Point has been running without interruption.

**Connected AP** Displays the name or MAC address of the Access Point this user is connected to.

If the user is offline, the following is displayed:

**MAC Address** Displays the MAC address of the user or guest.

**Hostname** Displays the name (if defined).

**Last Seen** Displays the last date and time the user was connected to the primary or guest network.

### Statistics

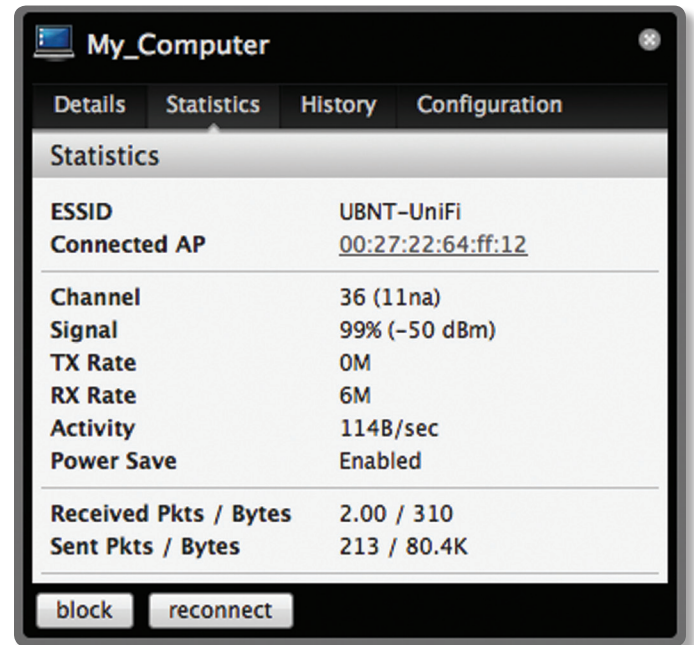

**ESSID** Displays the wireless network name (SSID) of the network that the user is connected to.

**Connected AP** Displays the MAC address or name of the Access Point the user is connected to.

**Channel** Displays the channel being used for wireless communication.

**Signal** Displays the signal level.

**TX Rate** Displays the transmit rate.

**RX Rate** Displays the reception rate.

**Activity** Displays user activity.

**Power Save** Indicates whether power saving is enabled.

**Received Pkts / Bytes** Displays the number of packets and total bytes received by the user.

**Sent Pkts / Bytes** Displays the number of packets and total bytes transmitted by the user.



**Note:** The *Statistics* tab will only appear when the user is connected.

## History

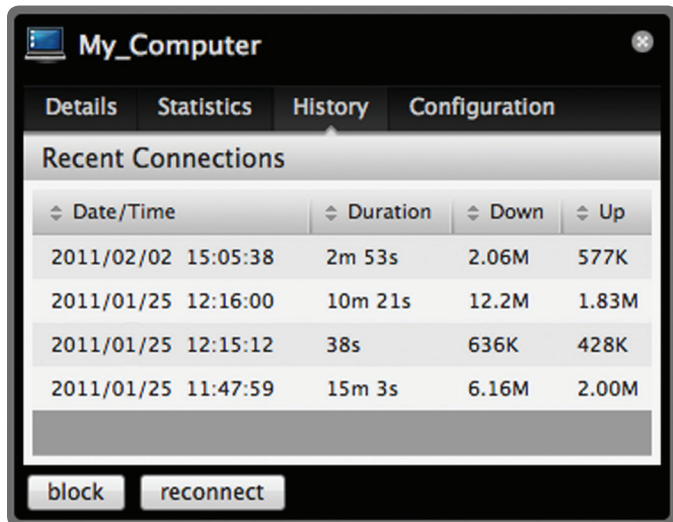

**Date/Time** Displays the date and time the user connected to the Access Point.

**Duration** Displays the time duration that the user was connected to the Access Point.

**Down** Displays how many bytes were downloaded by the user during the session.

**Up** Displays how many bytes were uploaded by the user during the session.

## Configuration

### Config

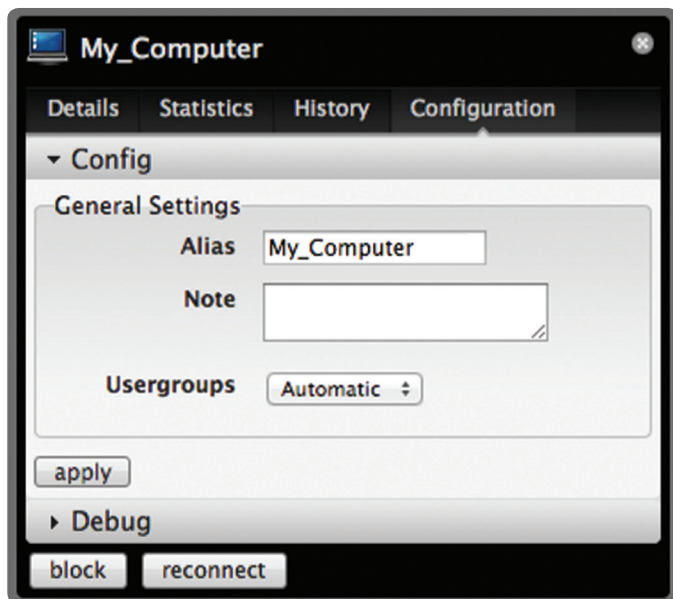

**Alias** Allows you to enter a name for the user. Click **apply** to save your name change.

**Note** Allows you to enter comments. Click **apply** to save your change. Once saved, the user will be designated a "Noted" client on the *All Clients* tab.

**Usergroups** Allows you to select the User Group to assign to the user. User Groups are set up under the *Settings* tab > *User Groups* option (see "**Settings > User Groups**" on page 18 for information on setting up User Groups).

Click **apply** to save your changes.

### Debug

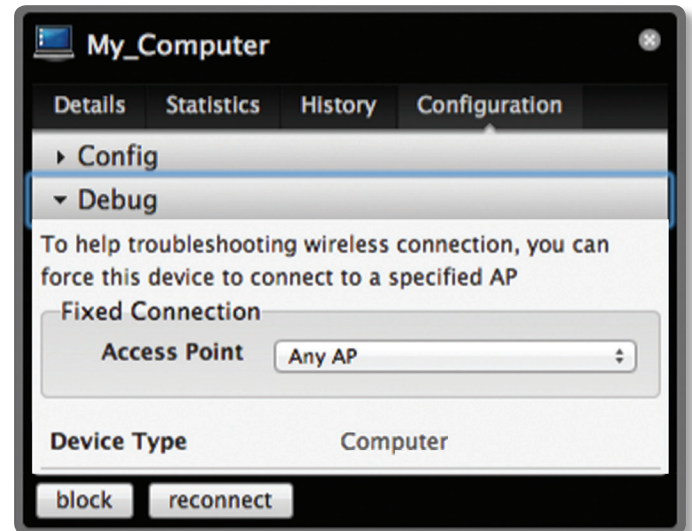

**Access Point** Allows you to force a device to connect to a specific Access Point. This device will then be designated a "Noted" client on the *All Clients* tab.

**Device Type** Displays the type of device. If the device is offline, "Unknown" is displayed.



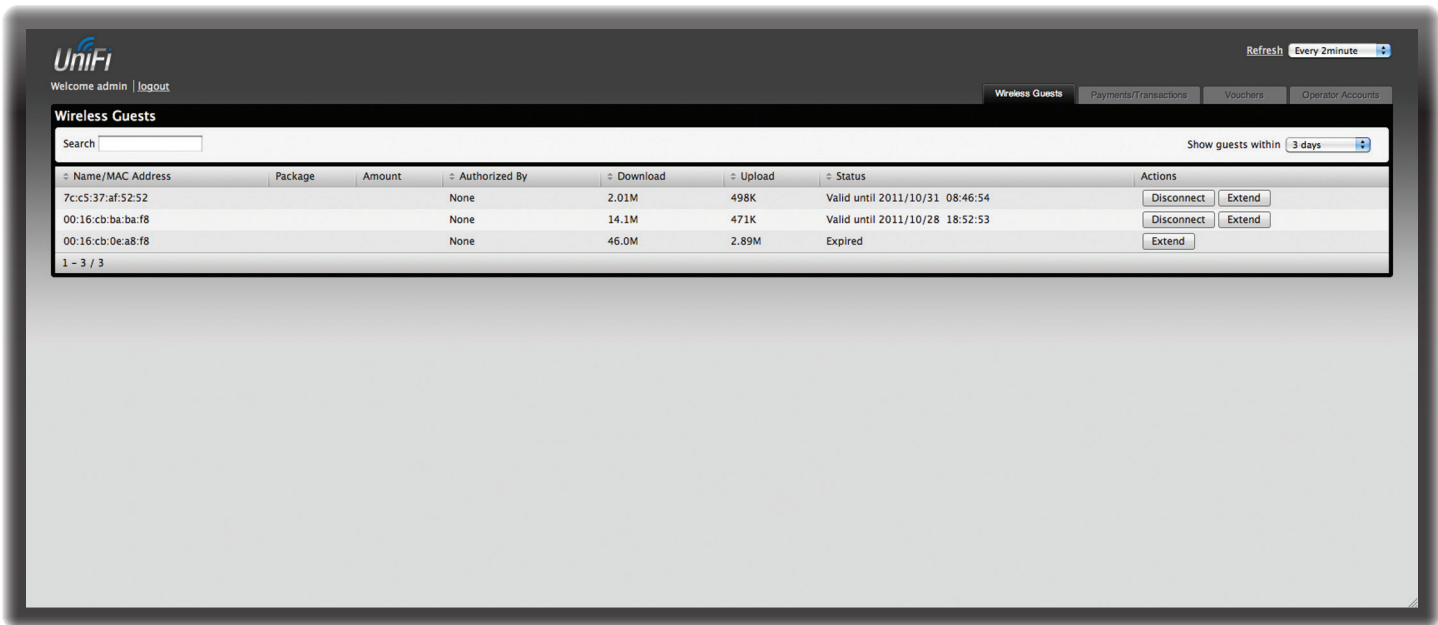

## Chapter 12: Hotspot Manager

*Hotspot Manager* includes four main tabs when accessed by the UniFi Controller admin account. These tabs include *Wireless Guests*, *Payments/Transactions*, *Vouchers*, and *Operator Accounts*.

The UniFi Controller admin can create operator accounts for the Hotspot Manager. Operator accounts are designed for use by hotels to service guests and have no access to other UniFi administrative features. Operator accounts will have access to three tabs after login: *Wireless Guests*, *Payments/Transactions*, and *Vouchers*.

### Wireless Guests

Lists the Hotspot's currently active wireless guests. Includes the keyword *Search* box and *Show guests within* drop-down selections (options include *last 24 hours*, *3 days*, *7 days*, *2 weeks*, *30 days*, and *120 days*).

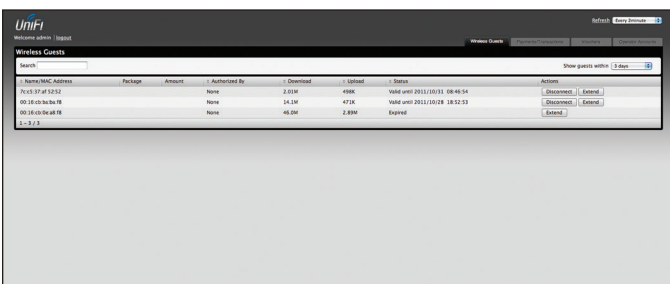

**Name/MAC Address** Displays the connected guest's device name or MAC address.

**Package** Displays the type of package that was purchased (if applicable).

**Amount** Displays amount paid for access (if applicable).

**Authorized By** Displays authorization method or none.

**Download** Displays the total number of bytes downloaded by the guest.

**Upload** Displays the total number of bytes uploaded by the guest.

**Status** Displays the remaining session time for the guest.

### Actions

- **Disconnect** Allows you to immediately disconnect a guest.
- **Extend** Allows you to extend a guest's session for an additional 24 hours every time you click this button. If you click it three times, you will extend the guest access for three more days.

### Payments/Transactions

Lists the Hotspot's payments and transactions. Includes the keyword *Search* box and *Show guests within* drop-down selections (options include *last 24 hours*, *3 days*, *7 days*, *2 weeks*, *30 days*, and *120 days*).

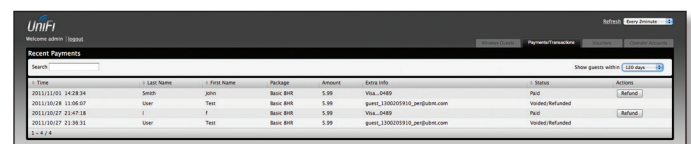

**Time** Displays the time and date of the transaction.

**Last Name** Displays the user's last name.

**First Name** Displays the user's first name.

**Package** Displays the package description.

**Amount** Displays the amount of the transaction.

**Extra Info** If the user paid via PayPal, the *Extra Info* field displays the email address associated with the PayPal account. If the user paid via credit card, the *Extra Info* field will display the type of credit card and the last four digits of the credit card used.

**Status** Displays the status of the transaction.

**Actions** Allows you to refund a customer if necessary by clicking the *Refund* button.

## Vouchers

Allows the creation of vouchers including a distributable code, duration values, and use restrictions.

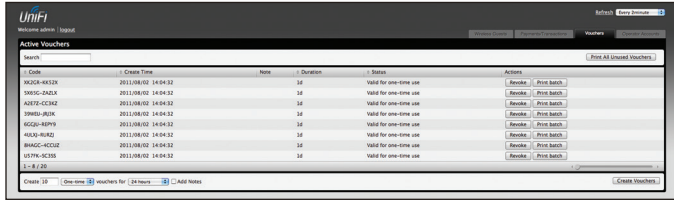

**Search** Enter keywords in the *Search* box to find a specific voucher based on *Code*, *Create Time*, or *Note* values.

**Print all Unused Vouchers** Click **Print All Unused Vouchers** to send a page to your printer with voucher code and validity details.

**Code** Displays a list of active voucher codes.

**Create Time** Displays the time and date the voucher was created.

**Note** Displays any notes that were added using the *Add Notes* option during voucher creation.

**Duration** Displays the duration of minutes, hours, or days that the voucher enables the user to access the Internet.

**Status** Indicates whether it is a single-use or multi-use voucher.

### Actions

- **Revoke** Immediately deactivates the selected voucher.
- **Print Batch** Prints the selected voucher.

**Active Voucher Page Slider** Adjust the slider from left to right to view all *Active Vouchers*.

**Create Vouchers** Includes the following:

- **Create** \_\_\_ Specify the number of vouchers to create.
- \_\_\_ **vouchers** Choose whether the voucher can be used *One-time* or for *Multi-use*.
- **for** \_\_\_ Choose how long the voucher is valid (options include *8 hours*, *24 hours*, *2 days*, *3 days*, *4 days*, *7 days*, or *User-defined*).
- **Add Notes** Select to add a note specific to the batch of vouchers created.

Click **Create Vouchers** to create the vouchers as specified.

## Operator Accounts

Allows the creation of *Operator Accounts* that can log in to *Hotspot Manager* to manage wireless guests, payments/transactions, and vouchers.

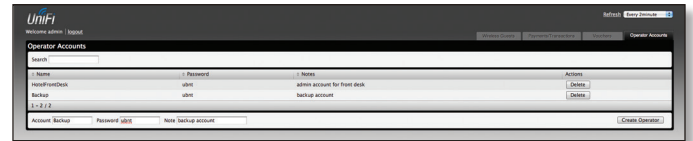

- **Search** Enter keywords in the *Search* box to find a specific operator account based on *Name*, *Password*, or *Notes* values.
- **Actions** Click **Delete** to remove an operator.
- **Account** Enter a name for the operator. The *Account* can only be A-Z, a-z, or 0-9. No spaces are allowed.
- **Password** Enter a password for the operator. The *Password* has to start with A-Z, a-z, or 0-9. The other characters can only be printable ASCII characters.
- **Note** If desired, enter a note to identify or describe the operator.
- **Create Operator** Click **Create Operator** to create the operator account as specified. To test the operator account, log out of the UniFi Controller software and log in using the operator credentials. Only the *Wireless Guests*, *Payments/Transactions*, and *Vouchers* tabs will appear.

# Appendix A: Portal Customization

## Overview

With *Portal Customization*, the UniFi Controller software allows complete branding of a portal implementation, allowing you to “white label” your wireless internet service as if you had developed it yourself.

In order to provide the maximum flexibility in your branding effort, the UniFi Controller software provides total access to the portal directory on the system in which it is installed.

This open architecture allows you to include unlimited content while keeping development simple through the use of plain .html (hand code or use any editor of your choice). Testing is simple and immediate by reloading changes from any browser.

## Enabling Portal Customization

By default, *Portal Customization* is disabled in all *Guest Portal* implementations. See **“Settings > Guest Control” on page 15** for more information on enabling the *Guest Portal* for the following authentication and landing page options: *No authentication, Simple Password, Hotspot*.

To enable *Portal Customization*, perform the following steps:

1. Go to **Settings** and select **Guest Control**.



2. Make sure that the Guest Portal is enabled and select an authentication method.

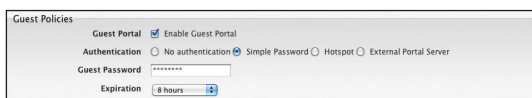

3. Select **Enable portal customization** and click **Apply**.

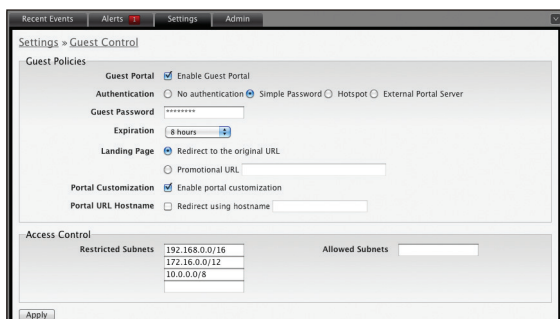

## Viewing the Default Portal

Once *Guest Portal > Portal Customization* is enabled, connect to the *Guest Network* SSID as shown below, depending on your platform.

### Windows

1. Go to **Connect to Network**.
  - **Windows 7** Right-click the *Network* icon.
  - **Windows Vista** Go to **Start > Connect To**.
  - **Windows XP** Right-click the *Wireless Network* icon in the *System Tray* (lower right corner of the screen) and then click **View Available Wireless Networks**.
2. Select the *Guest Network* SSID and click **Connect**.
3. Depending on the security type applied to the network, enter the security key or password. Click **OK** or **Connect**.
4. Launch your web browser and you will be directed to the default portal page for the authentication type configured on the *Guest Portal* (see **“Settings > Guest Control” on page 15** for screenshots of default portal pages by authentication method).

### Mac

1. Click the *AirPort* icon in the menu bar (top left side of the screen).
2. Select the *Guest Network* SSID and click **Connect**.
3. Depending on the security type applied to the network, enter the security key or password. Click **OK**.
4. Once connected, the *AirPort* icon will change from gray to solid black. The number of black lines indicates the signal strength.
5. Launch your web browser and you will be directed to the default portal page for the authentication type configured on the *Guest Portal* (see **“Settings > Guest Control” on page 15** for screenshots of default portal pages by authentication method).

## Setup

The html and css files are located on the system that the UniFi Controller software has been installed on. The file paths are in the following locations:

Mac:

/Applications/UniFi.app/Contents/Resources/data/portal

Windows:

<Drive\_Letter>:\Users\<Username>\Ubiquiti UniFi\data\portal

For specific instructions on accessing the files, refer to the specific operating system:

## Mac

1. Navigate to **Go > Applications**.

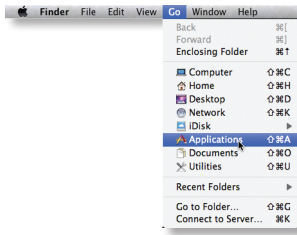

2. Control-click the **UniFi** application and select **Show Package Contents**.

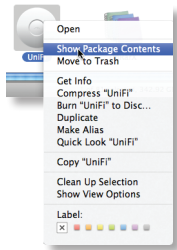

3. Double-click the **Contents** folder to open it.

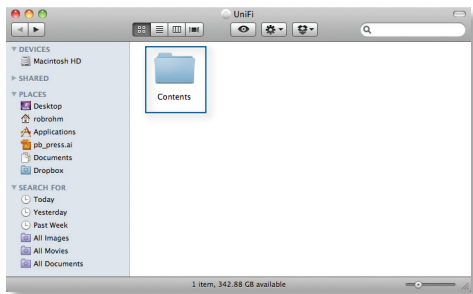

4. Double-click the **Resources** folder to open it.

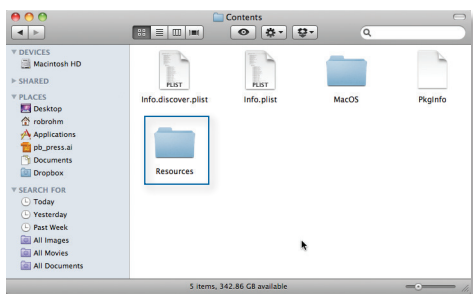

5. Double-click the **data** folder to open it.

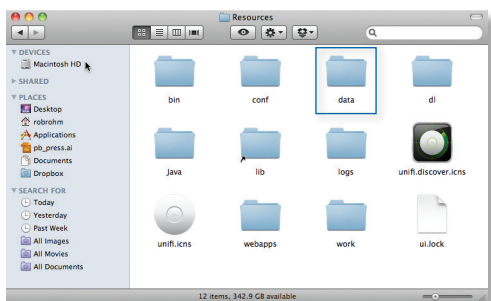

6. Double-click the **portal** folder to open it.

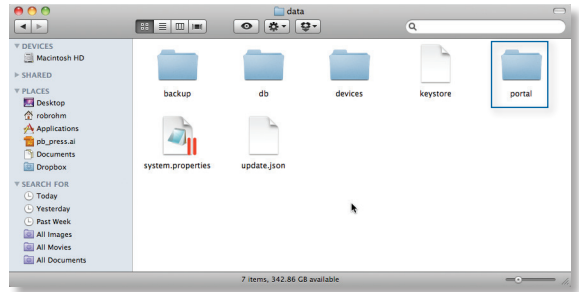

## Windows

The Windows files are located in the following location:  
**<Drive\_Letter>\<Users>\<Username>\Ubiquiti UniFi\data\portal**

## Customizable Default Files

The following default customizable html and css files can be found in the *portal* folder:

- **index.html** The main landing page.
- **payment.html** Used for credit card information submission. Requires https and also serves as an example of an additional .html page.
- **fail.html** Page displayed when there is an error handling a guest login.
- **reset-min.css**
- **styles.css**

Another important customizable file is located in the *bundle* folder. The *messages.properties* file can be edited with a text editor such as TextEdit. This defines package costs, length of access, package titles, and how the charge will appear on a customer's credit card. Error messages are also defined here.

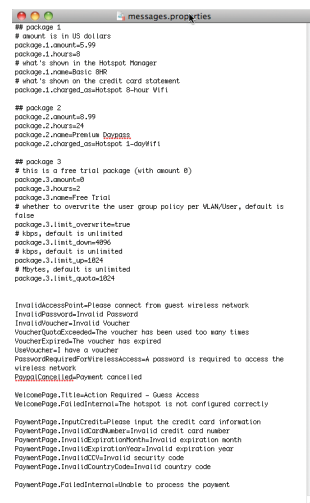

Additional details on portal customization can be found in our forum at:  
<http://wiki.ubnt.com/unifi-portal-customization>

# Appendix B: UniFi Discovery Utility

## Overview

The Ubiquiti UniFi Discovery Utility includes tools that allow the discovery and management of UniFi Enterprise WiFi System Access Points. It is installed automatically as part of the UniFi Controller software installation process. See **“Software Installation” on page 10** for more information.

## Launching the UniFi Discovery Utility

### Mac Users

From the Finder, click **Go > Applications** and double-click the *UniFi-Discover.app* icon.



### PC Users

Go to **Start > All Programs > Ubiquiti UniFi** and double-click the *UniFi-Discover* icon.

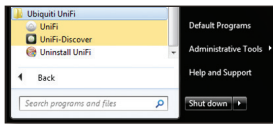

## UniFi Discovery Utility Interface

Upon launch, the UniFi Discovery Utility listens to Layer-2 broadcast/multicast beacons from UniFi Access Points in both a factory default state and an unmanaged state (adopted but unable to contact the UniFi Controller software).

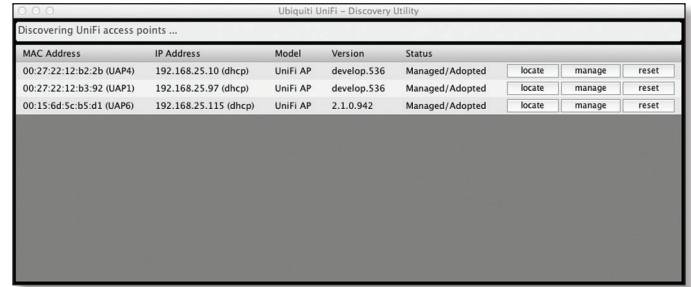

**MAC Address** Displays the MAC address and alias (in parentheses if specified – see **“Configuration” on page 37** for details on specifying an alias) of the Access Point.

**IP Address** Displays the IP address of the Access Point and the method used by the Access Point to obtain an IP address (in parentheses as *DHCP* or *Static*).

**Model** Displays the model name of the UniFi WiFi System Access Point.

**Version** The software version installed on the Access Point is displayed here.

**Status** Displays the current status of the Access Point. Possible statuses include: *Pending*, *Managed/Adopted*, *Login Failed*, and *IP Unreachable*.

**Locate** Click to locate the Access Point. The following window appears:

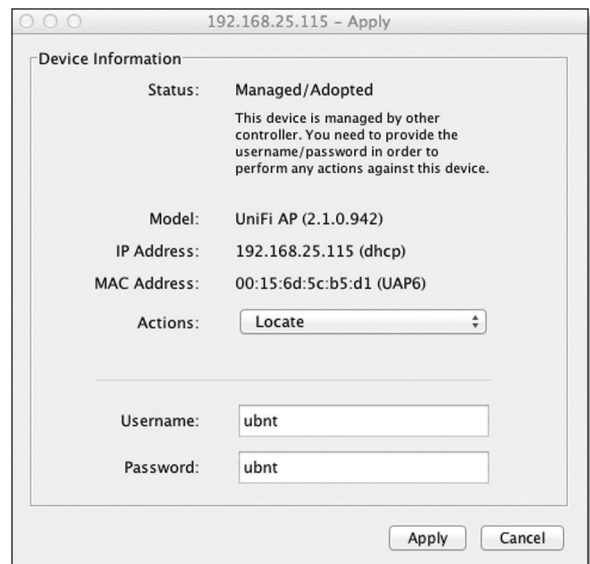

The LED on the Access Point will flash so that it can be identified from other Access Points. If the Access Point’s status requires the entry of a username and password, enter them before clicking *Apply*.

**Manage** Click to set the inform URL, allowing the Access Point to be managed by an instance of the UniFi Controller software running in a NOC or in the cloud (see **“Network Topology Requirements” on page 2** for a visual representation of this configuration). The following window appears:

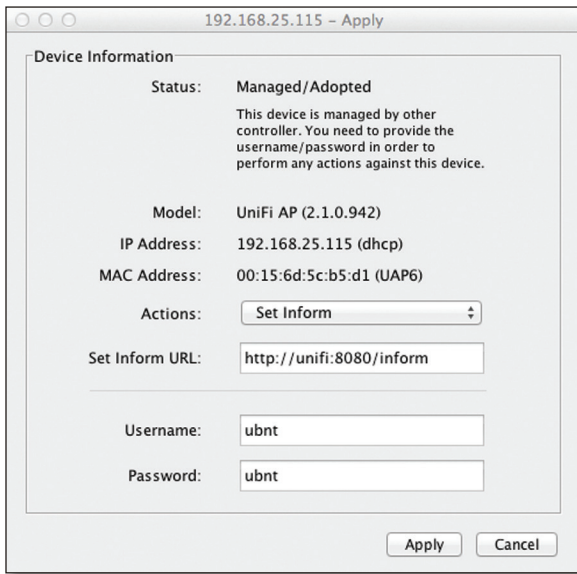

**Reboot** Click to reboot Access Point. The following window appears:

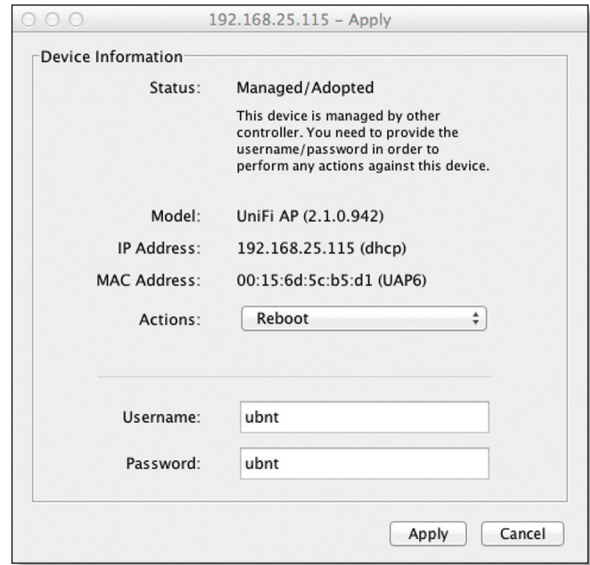

If the Access Point’s status requires the entry of a username and password, enter them before clicking *Apply*.

Enter the URL, port, and path to the instance of the UniFi Controller software that the Access Point is to be managed by. If the Access Point’s status requires the entry of a username and password, enter them before clicking *Apply*.

**Reset** Click to restore the Access Point to factory default settings. The following window appears:

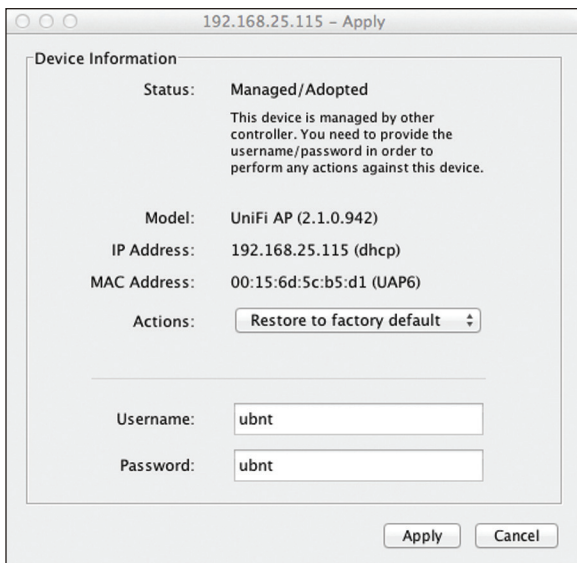

If the Access Point’s status requires the entry of a username and password, enter them before clicking *Apply*.

## Appendix C: Specifications

UniFi AP PRO	
Dimensions	200 x 200 x 36.5 mm
Weight	298 g (358 g with Mounting Kits)
Networking Interface	(2) 10/100/1000 Ethernet Ports
Buttons	Reset
Antennas	3 Integrated (Supports 3x3 MIMO with Spatial Diversity) 2 Integrated (Supports 2x2 MIMO with Spatial Diversity)
2.4 GHz	
5 GHz	
Wi-Fi Standards	802.11 a/b/g/n
Power Method	Passive Power over Ethernet (48V), 802.3af Supported
Power Supply	48V, 0.5A PoE Adapter (Included)
Maximum Power Consumption	12 W
Maximum TX Power	
2.4 GHz	30 dBm
5 GHz	22 dBm
BSSID	Up to Four Per Radio
Power Save	Supported
Wireless Security	WEP, WPA-PSK, WPA-TKIP, WPA2 AES, 802.11i
Certifications	CE, FCC, IC
Mounting	Wall/Ceiling (Kits Included)
Operating Temperature	-10 to 70° C
Operating Humidity	5 - 80% Condensing

Advanced Traffic Management	
VLAN	802.1Q
Advanced QoS	Per-User Rate Limiting
Guest traffic isolation	Supported
WMM	Voice, Video, Best Effort, and Background
Concurrent Clients	200+

Supported Data Rates (Mbps)	
Standards	Data Rates
802.11a	6, 9, 12, 18, 24, 36, 48, 54 Mbps
802.11n	6.5 Mbps to 450 Mbps (MCS0 - MCS23, HT 20/40)
802.11b	1, 2, 5.5, 11 Mbps
802.11g	6, 9, 12, 18, 24, 36, 48, 54 Mbps

UniFi AP-AC (UAP-AC)	
Dimensions	200 x 204 x 27 mm
Weight	508 g (566 g with Mounting Kits)
Networking Interface	(2) 10/100/1000 Ethernet Ports
Buttons	Reset
Antennas 2.4 GHz 5 GHz	3 Integrated (Supports 3x3 MIMO with Spatial Diversity) 3 Integrated (Supports 3x3 MIMO with Spatial Diversity)
Wi-Fi Standards	802.11 a/b/g/n/ac
Power Method	Passive Power over Ethernet (48V), 802.3at Supported (Supported Voltage Range: 39 to 57VDC)
Power Supply	48V, 0.5A PoE Gigabit Adapter Included
Maximum Power Consumption	22 W
Maximum TX Power 2.4 GHz 5 GHz	28 dBm 28 dBm
BSSID	Up to Four per Radio
Power Save	Supported
Wireless Security	WEP, WPA-PSK, WPA-TKIP, WPA2 AES, 802.11i
Certifications	CE, FCC, IC
Mounting	Wall/Ceiling (Kits Included)
Operating Temperature	-10 to 55° C
Operating Humidity	5 - 80% Condensing

Advanced Traffic Management	
VLAN	802.1Q
Advanced QoS	Per-User Rate Limiting
Guest Traffic Isolation	Supported
WMM	Voice, Video, Best Effort, and Background
Concurrent Clients	200+

Supported Data Rates (Mbps)	
Standard	Data Rates
802.11a	6, 9, 12, 18, 24, 36, 48, 54 Mbps
802.11n	6.5 Mbps to 450 Mbps (MCS0 - MCS23, HT 20/40)
802.11ac	6.5 Mbps to 1300 Mbps (MCS0 - MCS9 NSS1/2/3, VHT 20/40/80)
802.11b	1, 2, 5.5, 11 Mbps
802.11g	6, 9, 12, 18, 24, 36, 48, 54 Mbps



## Appendix D: Safety Notices

1. Read, follow, and keep these instructions.
2. Heed all warnings.
3. Only use attachments/accessories specified by the manufacturer.

 **WARNING:** Do not use this product in location that can be submerged by water.

 **WARNING:** Avoid using this product during an electrical storm. There may be a remote risk of electric shock from lightning.

### Electrical Safety Information

1. Compliance is required with respect to voltage, frequency, and current requirements indicated on the manufacturer's label. Connection to a different power source than those specified may result in improper operation, damage to the equipment or pose a fire hazard if the limitations are not followed.
2. There are no operator serviceable parts inside this equipment. Service should be provided only by a qualified service technician.
3. This equipment is provided with a detachable power cord which has an integral safety ground wire intended for connection to a grounded safety outlet.
  - a. Do not substitute the power cord with one that is not the provided approved type. Never use an adapter plug to connect to a 2-wire outlet as this will defeat the continuity of the grounding wire.
  - b. The equipment requires the use of the ground wire as a part of the safety certification, modification or misuse can provide a shock hazard that can result in serious injury or death.
  - c. Contact a qualified electrician or the manufacturer if there are questions about the installation prior to connecting the equipment.
  - d. Protective earthing is provided by Listed AC adapter. Building installation shall provide appropriate short-circuit backup protection.
  - e. Protective bonding must be installed in accordance with local national wiring rules and regulations.

## Appendix E: Warranty

### Limited Warranty

UBIQUITI NETWORKS, Inc (“UBIQUITI NETWORKS”) warrants that the product(s) furnished hereunder (the “Product(s)”) shall be free from defects in material and workmanship for a period of one (1) year from the date of shipment by UBIQUITI NETWORKS under normal use and operation. UBIQUITI NETWORKS’ sole and exclusive obligation and liability under the foregoing warranty shall be for UBIQUITI NETWORKS, at its discretion, to repair or replace any Product that fails to conform to the above warranty during the above warranty period. The expense of removal and reinstallation of any Product is not included in this warranty. The warranty period of any repaired or replaced Product shall not extend beyond its original term.

### Warranty Conditions

The above warranty does not apply if the Product:

- (I) has been modified and/or altered, or an addition made thereto, except by Ubiquiti Networks, or Ubiquiti Networks’ authorized representatives, or as approved by Ubiquiti Networks in writing;
- (II) has been painted, rebranded or physically modified in any way;
- (III) has been damaged due to errors or defects in cabling;
- (IV) has been subjected to misuse, abuse, negligence, abnormal physical, electromagnetic or electrical stress, including lightning strikes, or accident;
- (V) has been damaged or impaired as a result of using third party firmware; or
- (VI) has no original Ubiquiti MAC label, or is missing any other original Ubiquiti label(s).
- (VII) has not been received by Ubiquiti within 30 days of issuance of the RMA.

In addition, the above warranty shall apply only if: the product has been properly installed and used at all times in accordance, and in all material respects, with the applicable Product documentation; all Ethernet cabling runs use CAT5 (or above), and for outdoor installations, shielded Ethernet cabling is used, and for indoor installations, indoor cabling requirements are followed.

### Returns

No Products will be accepted for replacement or repair without obtaining a Return Materials Authorization (RMA) number from UBIQUITI NETWORKS during the warranty period, and the Products being received at UBIQUITI NETWORKS’ facility freight prepaid in accordance with the RMA process of UBIQUITI NETWORKS. Products returned without an RMA number will not be processed and will be returned freight collect or subject to disposal. Information on the RMA process and obtaining an RMA number can be found at: [www.ubnt.com/support/warranty](http://www.ubnt.com/support/warranty).

### Disclaimer

EXCEPT FOR ANY EXPRESS WARRANTIES PROVIDED HEREIN, UBIQUITI NETWORKS, ITS AFFILIATES, AND ITS AND THEIR THIRD PARTY DATA, SERVICE, SOFTWARE AND HARDWARE PROVIDERS HEREBY DISCLAIM AND MAKE NO OTHER REPRESENTATION OR WARRANTY OF ANY KIND, EXPRESS, IMPLIED OR STATUTORY, INCLUDING, BUT NOT LIMITED TO, REPRESENTATIONS, GUARANTEES, OR WARRANTIES OF MERCHANTABILITY, ACCURACY, QUALITY OF SERVICE OR RESULTS, AVAILABILITY, SATISFACTORY QUALITY, LACK OF VIRUSES, QUIET ENJOYMENT, FITNESS FOR A PARTICULAR PURPOSE AND NON-INFRINGEMENT AND ANY WARRANTIES ARISING FROM ANY COURSE OF DEALING, USAGE OR TRADE PRACTICE IN CONNECTION WITH SUCH PRODUCTS AND SERVICES. BUYER ACKNOWLEDGES THAT NEITHER UBIQUITI NETWORKS NOR ITS THIRD PARTY PROVIDERS CONTROL BUYER’S EQUIPMENT OR THE TRANSFER OF DATA OVER COMMUNICATIONS FACILITIES, INCLUDING THE INTERNET, AND THAT THE PRODUCTS AND SERVICES MAY BE SUBJECT TO LIMITATIONS, INTERRUPTIONS, DELAYS, CANCELLATIONS AND OTHER PROBLEMS INHERENT IN THE USE OF COMMUNICATIONS FACILITIES. UBIQUITI NETWORKS, ITS AFFILIATES AND ITS AND THEIR THIRD PARTY PROVIDERS ARE NOT RESPONSIBLE FOR ANY INTERRUPTIONS, DELAYS, CANCELLATIONS, DELIVERY FAILURES, DATA LOSS, CONTENT CORRUPTION, PACKET LOSS, OR OTHER DAMAGE RESULTING FROM ANY OF THE FOREGOING. In addition, UBIQUITI NETWORKS does not warrant that the operation of the Products will be error-free or that operation will be uninterrupted. In no event shall UBIQUITI NETWORKS be responsible for damages or claims of any nature or description relating to system performance, including coverage, buyer’s selection of products (including the Products) for buyer’s application and/or failure of products (including the Products) to meet government or regulatory requirements.

### Limitation of Liability

EXCEPT TO THE EXTENT PROHIBITED BY LOCAL LAW, IN NO EVENT WILL UBIQUITI OR ITS SUBSIDIARIES, AFFILIATES OR SUPPLIERS BE LIABLE FOR DIRECT, SPECIAL, INCIDENTAL, CONSEQUENTIAL OR OTHER DAMAGES (INCLUDING LOST PROFIT, LOST DATA, OR DOWNTIME COSTS), ARISING OUT OF THE USE, INABILITY TO USE, OR THE RESULTS OF USE OF THE PRODUCT, WHETHER BASED IN WARRANTY, CONTRACT, TORT OR OTHER LEGAL THEORY, AND WHETHER OR NOT ADVISED OF THE POSSIBILITY OF SUCH DAMAGES.

**Note**

Some countries, states and provinces do not allow exclusions of implied warranties or conditions, so the above exclusion may not apply to you. You may have other rights that vary from country to country, state to state, or province to province. Some countries, states and provinces do not allow the exclusion or limitation of liability for incidental or consequential damages, so the above limitation may not apply to you. EXCEPT TO THE EXTENT ALLOWED BY LOCAL LAW, THESE WARRANTY TERMS DO NOT EXCLUDE, RESTRICT OR MODIFY, AND ARE IN ADDITION TO, THE MANDATORY STATUTORY RIGHTS APPLICABLE TO THE LICENSE OF ANY SOFTWARE (EMBEDDED IN THE PRODUCT) TO YOU. The United Nations Convention on Contracts for the International Sale of Goods shall not apply to any transactions regarding the sale of the Products.

## Appendix F: Compliance Information

### FCC

Changes or modifications not expressly approved by the party responsible for compliance could void the user's authority to operate the equipment.

This device complies with Part 15 of the FCC Rules. Operation is subject to the following two conditions:

1. this device may not cause harmful interference, and
2. this device must accept any interference received, including interference that may cause undesired operation.

NOTE: This equipment has been tested and found to comply with the limits for a Class A digital device, pursuant to part 15 of the FCC Rules. These limits are designed to provide reasonable protection against harmful interference when the equipment is operated in a commercial environment. This equipment generates, uses, and can radiate radio frequency energy and, if not installed and used in accordance with the instruction manual, may cause harmful interference to radio communications. Operations of this equipment in a residential area is likely to cause harmful interference in which case the user will be required to correct the interference at his own expense.

For MPE and antenna usage details, please visit our website at [www.ubnt.com/products](http://www.ubnt.com/products)

### Industry Canada

This Class A digital apparatus complies with Canadian ICES-003.

To reduce potential radio interference to other users, the antenna type and its gain should be so chosen that the equivalent isotropically radiated power (e.i.r.p.) is not more than that permitted for successful communication.

This device complies with Industry Canada licence-exempt RSS standard(s). Operation is subject to the following two conditions:

1. this device may not cause interference, and
2. this device must accept any interference, including interference that may cause undesired operation of the device.

Cet appareil numérique de la classe A est conforme à la norme NMB-003 Canada.

Pour réduire le risque d'interférence aux autres utilisateurs, le type d'antenne et son gain doivent être choisis de façon que la puissance isotrope rayonnée équivalente (PIRE) ne dépasse pas ce qui est nécessaire pour une communication réussie.

Cet appareil est conforme à la norme RSS Industrie Canada exempts de licence norme(s). Son fonctionnement est soumis aux deux conditions suivantes:

1. cet appareil ne peut pas provoquer d'interférences et
2. cet appareil doit accepter toute interférence, y compris les interférences qui peuvent causer un mauvais fonctionnement du dispositif.

### RF Exposure Warning

The antennas used for this transmitter must be installed to provide a separation distance of at least 20 cm from all persons and must not be located or operating in conjunction with any other antenna or transmitter, except as listed for this product's certification.

Les antennes utilisées pour ce transmetteur doivent être installées en considérant une distance de séparation de toute personnes d'au moins 20 cm et ne doivent pas être localisé ou utilisé en conflit avec tout autre antenne ou transmetteur, excluant la liste de certification de ce produit.

### CE Marking

CE marking on this product represents the product is in compliance with all directives that are applicable to it.

### Alert sign! Follows CE marking

Alert sign must be indicated if a restriction on use applied to the product and it must follow the CE marking.



## RoHS/WEEE Compliance Statement



### English

European Directive 2002/96/EC requires that the equipment bearing this symbol on the product and/or its packaging must not be disposed of with unsorted municipal waste. The symbol indicates that this product should be disposed of separately from regular household waste streams. It is your responsibility to dispose of this and other electric and electronic equipment via designated collection facilities appointed by the government or local authorities. Correct disposal and recycling will help prevent potential negative consequences to the environment and human health. For more detailed information about the disposal of your old equipment, please contact your local authorities, waste disposal service, or the shop where you purchased the product.

### Deutsch

Die Europäische Richtlinie 2002/96/EC verlangt, dass technische Ausrüstung, die direkt am Gerät und/oder an der Verpackung mit diesem Symbol versehen ist, nicht zusammen mit unsortiertem Gemeindeabfall entsorgt werden darf. Das Symbol weist darauf hin, dass das Produkt von regulärem Haushaltsmüll getrennt entsorgt werden sollte. Es liegt in Ihrer Verantwortung, dieses Gerät und andere elektrische und elektronische Geräte über die dafür zuständigen und von der Regierung oder örtlichen Behörden dazu bestimmten Sammelstellen zu entsorgen. Ordnungsgemäßes Entsorgen und Recyceln trägt dazu bei, potentielle negative Folgen für Umwelt und die menschliche Gesundheit zu vermeiden. Wenn Sie weitere Informationen zur Entsorgung Ihrer Altgeräte benötigen, wenden Sie sich bitte an die örtlichen Behörden oder städtischen Entsorgungsdienste oder an den Händler, bei dem Sie das Produkt erworben haben.

### Español

La Directiva 2002/96/CE de la UE exige que los equipos que lleven este símbolo en el propio aparato y/o en su embalaje no deben eliminarse junto con otros residuos urbanos no seleccionados. El símbolo indica que el producto en cuestión debe separarse de los residuos domésticos convencionales con vistas a su eliminación. Es responsabilidad suya desechar este y cualesquiera otros aparatos eléctricos y electrónicos a través de los puntos de recogida que ponen a su disposición el gobierno y las autoridades locales. Al desechar y reciclar correctamente estos aparatos estará contribuyendo a evitar posibles consecuencias negativas para el medio ambiente y la salud de las personas. Si desea obtener información más

detallada sobre la eliminación segura de su aparato usado, consulte a las autoridades locales, al servicio de recogida y eliminación de residuos de su zona o pregunte en la tienda donde adquirió el producto.

### Français

La directive européenne 2002/96/CE exige que l'équipement sur lequel est apposé ce symbole sur le produit et/ou son emballage ne soit pas jeté avec les autres ordures ménagères. Ce symbole indique que le produit doit être éliminé dans un circuit distinct de celui pour les déchets des ménages. Il est de votre responsabilité de jeter ce matériel ainsi que tout autre matériel électrique ou électronique par les moyens de collecte indiqués par le gouvernement et les pouvoirs publics des collectivités territoriales. L'élimination et le recyclage en bonne et due forme ont pour but de lutter contre l'impact néfaste potentiel de ce type de produits sur l'environnement et la santé publique. Pour plus d'informations sur le mode d'élimination de votre ancien équipement, veuillez prendre contact avec les pouvoirs publics locaux, le service de traitement des déchets, ou l'endroit où vous avez acheté le produit.

### Italiano

La direttiva europea 2002/96/EC richiede che le apparecchiature contrassegnate con questo simbolo sul prodotto e/o sull'imballaggio non siano smaltite insieme ai rifiuti urbani non differenziati. Il simbolo indica che questo prodotto non deve essere smaltito insieme ai normali rifiuti domestici. È responsabilità del proprietario smaltire sia questi prodotti sia le altre apparecchiature elettriche ed elettroniche mediante le specifiche strutture di raccolta indicate dal governo o dagli enti pubblici locali. Il corretto smaltimento ed il riciclaggio aiuteranno a prevenire conseguenze potenzialmente negative per l'ambiente e per la salute dell'essere umano. Per ricevere informazioni più dettagliate circa lo smaltimento delle vecchie apparecchiature in Vostro possesso, Vi invitiamo a contattare gli enti pubblici di competenza, il servizio di smaltimento rifiuti o il negozio nel quale avete acquistato il prodotto.

# Appendix G: Declaration of Conformity

Česky [Czech]	UBIQUITI NETWORKS tímto prohlašuje, že tento UBIQUITI NETWORKS device, je ve shodě se základními požadavky a dalšími požadavky stanovenými směrnicí 1999/5/EC.	Malti [Maltese]	Hawnhekk, UBIQUITI NETWORKS, jiddikjara li dan UBIQUITI NETWORKS device, jikkonforma mal- ti ijjiet essenzjali u ma provvedimenti o rajn relevanti li hemm fid-Dirrettiva 1999/5/EC.
Dansk [Danish]	Undertegnede UBIQUITI NETWORKS erklærer herved, at følgende udstyr UBIQUITI NETWORKS device, overholder de væsentlige krav og øvrige relevante krav i direktiv 1999/5/EF.	Norsk [Norwegian]	UBIQUITI NETWORKS erklærer herved at utstyret UBIQUITI NETWORKS device, er i samsvar med de grunnleggende krav og øvrige relevante krav i direktiv 1999/5/EF.
Nederlands [Dutch]	Hierbij verklaart UBIQUITI NETWORKS dat het toestel UBIQUITI NETWORKS device, in overeenstemming is met de essentiële eisen en de andere relevante bepalingen van richtlijn 1999/5/EG. Bij deze verklaart UBIQUITI NETWORKS dat deze UBIQUITI NETWORKS device, voldoet aan de essentiële eisen en aan de overige relevante bepalingen van Richtlijn 1999/5/EC.	Slovensky [Slovak]	UBIQUITI NETWORKS týmto vyhlasuje, že UBIQUITI NETWORKS device, spĺa základné požiadavky a v etky príslušné ustanovenia Smernice 1999/5/ES.
English	Hereby, UBIQUITI NETWORKS, declares that this UBIQUITI NETWORKS device, is in compliance with the essential requirements and other relevant provisions of Directive 1999/5/EC.	Svenska [Swedish]	Härmed intygar UBIQUITI NETWORKS att denna UBIQUITI NETWORKS device, står i överensstämmelse med de väsentliga egenskapskrav och övriga relevanta bestämmelser som framgår av direktiv 1999/5/EG.
Eesti [Estonian]	Käesolevaga kinnitab UBIQUITI NETWORKS seadme UBIQUITI NETWORKS device, vastavust direktiivi 1999/5/EÜ põhinõuetele ja nimetatud direktiivist tulenevatele teistele asjakohastele sätetele.	Español [Spanish]	Por medio de la presente UBIQUITI NETWORKS declara que el UBIQUITI NETWORKS device, cumple con los requisitos esenciales y cualesquiera otras disposiciones aplicables o exigibles de la Directiva 1999/5/CE.
Suomi [Finnish]	UBIQUITI NETWORKS vakuuttaa täten että UBIQUITI NETWORKS device, tyypinen laite on direktiivin 1999/5/EY oleellisten vaatimusten ja sitä koskevien direktiivin muiden ehtojen mukainen.	Polski [Polish]	Niniejszym, firma UBIQUITI NETWORKS o wiadcza, że produkt serii UBIQUITI NETWORKS device, spełnia zasadnicze wymagania i inne istotne postanowienia Dyrektywy 1999/5/EC.
Français [French]	Par la présente UBIQUITI NETWORKS déclare que l'appareil UBIQUITI NETWORKS device est conforme aux exigences essentielles et aux autres dispositions pertinentes de la directive 1999/5/CE. Par la présente, UBIQUITI NETWORKS déclare que ce UBIQUITI NETWORKS device, est conforme aux exigences essentielles et aux autres dispositions de la directive 1999/5/CE qui lui sont applicables.	Português [Portuguese]	UBIQUITI NETWORKS declara que este UBIQUITI NETWORKS device, está conforme com os requisitos essenciais e outras disposições da Directiva 1999/5/CE.
Deutsch [German]	Hiermit erklärt UBIQUITI NETWORKS, dass sich diese UBIQUITI NETWORKS device, in Übereinstimmung mit den grundlegenden Anforderungen und den anderen relevanten Vorschriften der Richtlinie 1999/5/EG befindet“. (BMW) Hiermit erklärt UBIQUITI NETWORKS die Übereinstimmung des Gerätes UBIQUITI NETWORKS device, mit den grundlegenden Anforderungen und den anderen relevanten Festlegungen der Richtlinie 1999/5/EG. (Wien)	Română [Romanian]	Prin prezenta, UBIQUITI NETWORKS declară că acest dispozitiv UBIQUITI NETWORKS este în conformitate cu cerințele esențiale și alte prevederi relevante ale Directivei 1999/5/CE.
Ελληνική [Greek]	ΜΕ ΤΗΝ ΠΑΡΟΥΣΑ UBIQUITI NETWORKS ΔΗΛΩΝΕΙ ΟΤΙ UBIQUITI NETWORKS device, ΣΥΜΜΟΡΦΩΝΕΤΑΙ ΠΡΟΣ ΤΙΣ ΟΥΣΙΩΔΕΙΣ ΑΠΑΙΤΗΣΕΙΣ ΚΑΙ ΤΙΣ ΛΟΙΠΕΣ ΣΧΕΤΙΚΕΣ ΔΙΑΤΑΞΕΙΣ ΤΗΣ ΟΔΗΓΙΑΣ 1999/5/ΕΚ.		
Magyar [Hungarian]	Alulírott, UBIQUITI NETWORKS nyilatkozom, hogy a UBIQUITI NETWORKS device, megfelel a vonatkozó alapvető követelményeknek és az 1999/5/EC irányelv egyéb előírásainak.		
Íslenska [Icelandic]	Hér með lýsir UBIQUITI NETWORKS yfir ví a UBIQUITI NETWORKS device, er í samræmi við grunnkröfur og a rar kröfur, sem ger ar eru í tilskipun 1999/5/EC.		
Italiano [Italian]	Con la presente UBIQUITI NETWORKS dichiara che questo UBIQUITI NETWORKS device, è conforme ai requisiti essenziali ed alle altre disposizioni pertinenti stabilite dalla direttiva 1999/5/CE.		
Latviski [Latvian]	Ar o UBIQUITI NETWORKS deklar , ka UBIQUITI NETWORKS device, atbilst Direkt vas 1999/5/EK b tiskaj m pras b m un citiem ar to saist tajiem noteikumiem.		
Lietuvi [Lithuanian]	UBIQUITI NETWORKS deklaruoja, kad šis UBIQUITI NETWORKS įrenginys atitinka esminius reikalavimus ir kitas 1999/5/EB Direktyvos nuostatas.		

## Appendix H: Contact Information

---

### Ubiquiti Networks Support

Ubiquiti Support Engineers are located around the world and are dedicated to helping customers resolve software, hardware compatibility, or field issues as quickly as possible. We strive to respond to support inquiries within a 24-hour period.

#### Online Resources

Support: [support.ubnt.com](http://support.ubnt.com)

Community: [community.ubnt.com](http://community.ubnt.com)

Downloads: [downloads.ubnt.com](http://downloads.ubnt.com)



2580 Orchard Parkway  
San Jose, CA 95131  
[www.ubnt.com](http://www.ubnt.com)

© 2012-2013 Ubiquiti Networks, Inc. All rights reserved. UniFi™ and Ubiquiti Networks™ are trademarks of Ubiquiti Networks, Inc. Google Maps™ is a trademark of Google, Inc. PayPal™ is a trademark of PayPal, Inc. WPA™ and WPA2™ are trademarks of the Wi-Fi Alliance.